



The Synchronization Experts.



# MANUAL

## SyncFire 1200

High performant NTP Server

August 8, 2022

Meinberg Funkuhren GmbH & Co. KG



# Front view (Frontansicht) SyncFire 1200

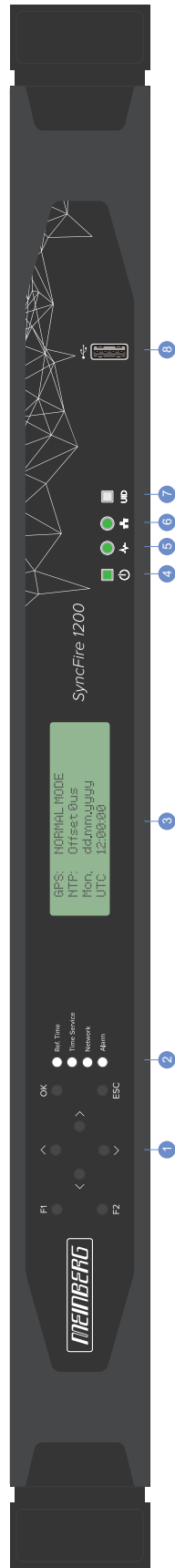

## English

1. Function buttons: 4-way navigation; F1, F2, OK, ESC
2. Status LEDs: Ref. Time, Time Service, Network, Alarm
3. LC-Display, 4 x 20 characters
4. Power On/Standby button and system power LED
5. Health LED
6. NIC status LED
7. UID button/LED
8. USB 3.0 port

## Deutsch

1. Funktionstasten: 4-Richtungs-Navigation - F1, F2, OK, ESC
2. Status LEDs: Ref. Time, Time Service, Network, Alarm
3. LC-Display, 4 x 20 Zeichen
4. Power On / Standby-Button und System-Power-LED
5. Health-LED
6. NIC-Status-LED
7. UID-Button / LED
8. USB 3.0 Anschlussport

# Rear view (Rückansicht) SyncFire 1200

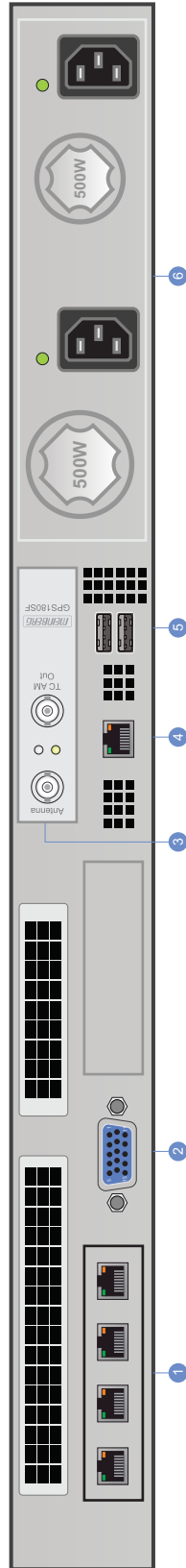

## English

1. Network connectors 10/100/1000BASE-T
2. VGA port (standard operation)
3. GPS or GNS receiver
4. Network management port
5. USB 3.0 ports
6. Power supply bay (redundant power supplies)

## Deutsch

1. Netzwerkanschlüsse 10/100/1000BASE-T
2. VGA-Port (Standard-Betrieb)
3. GPS- oder GNS-Empfänger
4. Netzwerk-Management-Port
5. USB 3.0 Anschlüsse
6. Stromanschluss (redundante Netzteile)



Option: additional network ports 10GBASE SFP

# Table of Contents

<b>1</b>	<b>Imprint</b>	<b>1</b>
<b>2</b>	<b>Safety instructions for building-in equipment</b>	<b>2</b>
2.1	Important Safety Information and Safety Precautions	3
2.2	Used Symbols	4
2.3	Product Documentation	5
2.4	Security during Installation	6
2.5	Safety During Operation	9
2.6	Safety During Maintenance	10
2.7	Handling of Batteries	11
2.8	Cleaning and Care	12
2.9	Prevention of ESD Damage	12
2.10	Return of Electrical and Electronic Equipment	13
<b>3</b>	<b>The Modular System SyncFire 1200</b>	<b>14</b>
3.1	Network Configuration Concept	15
3.2	Why to use a Network Time Server?	16
<b>4</b>	<b>Before you start</b>	<b>17</b>
4.1	Text and Syntax Conventions	17
4.2	Required Tools	18
4.3	Abbreviation List	19
<b>5</b>	<b>Installation of the GPS Antenna</b>	<b>20</b>
<b>6</b>	<b>Technical Appendix: GPS Antenna + Accessories</b>	<b>25</b>
6.1	Technical Specifications: Antenna Cable	27
6.2	Antenna Short Circuit	27
6.3	Technical Specifications: MBG S-PRO Surge Protection	28
6.3.1	MBG S-PRO: Physical Dimensions	30
6.3.2	Installation and Grounding	30
<b>7</b>	<b>Information GNSS Antennas</b>	<b>31</b>
7.1	Installation of the Multi-GNSS Antenna	31
<b>8</b>	<b>Quick Start</b>	<b>35</b>
<b>9</b>	<b>Booting the GNSS Receiver</b>	<b>36</b>
<b>10</b>	<b>Indicators and Function Keys on the Front Panel</b>	<b>37</b>
10.1	Control Elements	38
<b>11</b>	<b>Available Interfaces for Configuration and Monitoring</b>	<b>39</b>
<b>12</b>	<b>Attachment: Technical Information</b>	<b>41</b>
12.1	Technical Specifications SyncFire 1200	41
12.2	Rear Panel Connectors	42
12.3	1000BASE-T Gigabit Network Port	43
12.4	10 Gigabit SFP+	43
12.5	Antenna Input: GPS Reference Clock	44
12.6	Antenna Input: GNSS Reference Clock	45
12.7	Time Code AM Output	46
<b>13</b>	<b>RoHS and WEEE</b>	<b>47</b>



# 1 Imprint

**Meinberg Funkuhren GmbH & Co. KG**  
Lange Wand 9, 31812 Bad Pyrmont, Germany

Phone: + 49 (0) 52 81 / 93 09 - 0  
Fax: + 49 (0) 52 81 / 93 09 - 230

Website: <https://www.meinbergglobal.com>  
Email: [info@meinberg.de](mailto:info@meinberg.de)

Date: August 8, 2022

## 2 Safety instructions for building-in equipment

The SyncFire 1200 cannot operate as a standard server. Meinberg's SyncFire 1200 was developed to operate as a powerful NTP time server and does not provide the needed operation system to be deployed as a standard server.

Make sure that the server is acclimatized for the time indicated in this table before putting it into operation:

<b>Temperature</b>	<b>Temperature difference</b>	<b>Minimum acclimatization time</b>
Operating / Non operating	20 °C (36 °F)	60 minutes
<b>Altitude</b>	<b>Altitude change rate</b>	<b>Minimum acclimatization time</b>
Operating / Non operating	457 m (1500 ft)	1 minute



## 2.1 Important Safety Information and Safety Precautions

The following safety information must be observed whenever the device is being installed or operated. Failure to observe this safety information and other special warnings or operating instructions in the product manuals constitutes improper usage and may violate safety standards and the manufacturer's requirements.



Depending on the configuration of your device or installed options, some information may not specifically apply to your device.



The device satisfies the requirements of the following EU regulations: EMC Directive, Low Voltage Directive, RoHS Directive and—where applicable—the Radio Equipment Directive.

If a procedure is marked with the following signal words, you may only proceed with it if you have understood and fulfilled all requirements. Hazard notices and other relevant information are classified and indicated as such in this manual according to the following system:



### DANGER!

This signal word indicates a hazard with a high risk level. Such a notice refers to a procedure or other action that will very likely result in serious injury or even death if not observed or if improperly performed.



### WARNING!

This signal indicates a hazard with a medium risk level. Such a notice refers to a procedure or other action that may result in serious injury or even death if not observed or if improperly performed.



### CAUTION!

This signal word indicates a hazard with a low risk level. Such a notice refers to a procedure or other action that may result in minor injury if not observed or if improperly performed.















### ATTENTION!

This signal word refers to a procedure or other action that may result in product damage or the loss of important data if not observed or if improperly performed.

## 2.2 Used Symbols

The following symbols and pictograms are used in this manual. Pictograms are used in particular to indicate potential hazards in all hazard categories.

Symbol	Beschreibung / Description
	IEC 60417-5031 Gleichstrom / <i>Direct current</i>
	IEC 60417-5032 Wechselstrom / <i>Alternating current</i>
	IEC 60417-5017 Erdungsanschluss / <i>Earth (ground) terminal</i>
	IEC 60417-5019 Schutzleiteranschluss / <i>Protective earth (ground) terminal</i>
	ISO 7000-0434A Vorsicht / <i>Caution</i>
	IEC 60417-6042 Vorsicht, Risiko eines elektrischen Schlages / <i>Caution, risk of electric shock</i>
	IEC 60417-5041 Vorsicht, heiße Oberfläche / <i>Caution, hot surface</i>
	IEC 60417-6056 Vorsicht, Gefährlich sich bewegende Teile / <i>Caution, moving parts</i>
	IEC 60417-6172 Trennen Sie alle Netzstecker / <i>Disconnect all power connectors</i>
	IEC 60417-5134 Elektrostatisch gefährdete Bauteile / <i>Electrostatic Discharge Sensitive Devices</i>
	IEC 60417-6222 Information generell / <i>General information</i>
 	2012/19/EU Dieses Produkt fällt unter die B2B Kategorie. Zur Entsorgung muss es an den Hersteller übergeben werden. <i>This product is handled as a B2B-category product. To ensure that the product is disposed of in a WEEE-compliant fashion, it must be returned to the manufacturer.</i>

## 2.3 Product Documentation

Detailed product documentation is provided on a USB flash drive delivered with the system. The manuals can also be downloaded from the Meinberg website at <https://www.meinbergglobal.com>, where you can enter your system name into the search box at the top of the page to find the relevant manual. Alternatively, contact Meinberg Support for further assistance.



This manual contains important safety instructions for the installation and operation of the device. Please read this manual thoroughly before using the device.

This device may only be used for the purpose described in this manual. In particular, the specified operating limits of the device must be heeded. The person setting up the device is responsible for safety matters in relation to any larger system in which the device is installed!

Failure to observe these instructions may have an adverse impact on device safety!

Please keep this manual in a safe place.

This manual is only intended to be used by qualified electricians, or by persons who have been appropriately instructed by a qualified electrician and who are familiar with applicable national standards and with safety rules & regulations. This device may only be installed, set up, and operated by qualified personnel.

## 2.4 Security during Installation



### WARNING!

#### Preparing for Commissioning

This built-in unit, has been designed and examined according to the requirements of the standard IEC 62368-1 "Audio/video, information and communication technology equipment - Part 1: Safety requirements".

When the built-in unit is used in a terminal (e.g., housing cabinet), additional requirements according to Standard IEC 62368-1 must be observed and complied with. In particular, the general requirements and the safety of electrical equipment (such as IEC, VDE, DIN, ANSI) as well as the applicable national standards are to be observed.

The device has been developed for use in the industrial sector as well as in residential areas and can only be used in such environments. For environments with higher levels of soiling, additional measures, e.g. Installation in an air-conditioned control cabinet required.

#### Transport, Unpacking, Installation

If the unit is brought into the operating room from a cold environment, condensation may occur, wait until the unit is temperature-controlled and absolutely dry before operating it.

When unpacking, setting up, and before operating the equipment, be sure to read the information on the hardware installation and the specifications of the equipment. These include, for example, dimensions, electrical characteristics, and necessary ambient and climatic conditions, etc.

The fire protection must be ensured in the installed state.

For mounting, the housing must not be damaged. No holes may be drilled in the housing.

For safety reasons, the device with the highest mass should be installed in the lowest position of the rack. Other devices must be placed from the bottom to the top.

The device must be protected against mechanical stress such as vibration or shock.



#### Connecting Data Cables

During a thunderstorm, data transmission lines must not be connected or disconnected (risk of lightning).

When wiring the devices, the cables must be connected or disconnected in the order of the arrangement described in the user documentation accompanying the device. Always attach all cables to the plug during connection and removal. Never pull the cable itself. Pulling the cable can cause the cables to disconnect from the plug.

Install the cables in way that they do not constitute a hazard (danger of tripping) and are not damaged, i.e. kinked.

#### Connecting Power Supply

This equipment is operated at a hazardous voltage. Non-observance of the safety instructions in this manual may result in serious personal injury or property damage.

Before operation, check that all cables and lines work properly and are undamaged. Pay particular attention to the facts that the cables do not have kinks or that they are not too short around corners, and no objects are placed on the cables. Also make sure that all connections are secure.

Faulty shielding or cabling will endanger your health (electrical shock) and may destroy other equipment.

Ensure that all necessary safety precautions have been taken. Make all connections to a unit before turning on the power. Observe the safety instructions on the device (see safety symbols).

The metal housing of the device is grounded. It must be ensured that enough air and creepage distances to neighboring voltage-carrying parts are provided during assembly in the control cabinet and no short circuits are caused.

In the case of malfunctions or servicing (e.g. in the event of a damaged housing or power cable or when fluids or foreign objects enter), the current flow can be interrupted. Questions about the house installation, need to be clarified with your house administration.

The power supply should be connected with a short, low-inductance line.

AC Power Supply	DC Power Supply
<ul style="list-style-type: none"> <li>• The device is a Protection Class 1 device and may only be connected to a grounded outlet (TN system).</li> <li>• For safe operation, the installation must be protected by a fuse of a rating not exceeding 16 A and equipped with a residual-current circuit breaker in accordance with applicable national standards.</li> <li>• The disconnection of the appliance from the mains power supply must always be performed from the mains socket and not from the appliance itself.</li> <li>• Mains-powered appliances are equipped with a safety-tested mains cable designed for use in the country of operation and may only be connected to a grounded shockproof socket, otherwise electric shock may occur.</li> <li>• Make sure that the mains socket on the appliance or the mains socket of the house installation is readily accessible for the user so that the mains cable can be pulled out of the socket in an emergency.</li> </ul>	<ul style="list-style-type: none"> <li>• In accordance with IEC 62368-1, it must be possible to disconnect the appliance from the supply voltage from a point other than the appliance itself (e.g., from the primary circuit breaker).</li> <li>• The power supply plug may only be fitted or dismantled while the appliance is isolated from the power supply (e.g., disconnected at the primary circuit breaker).</li> <li>• Supply cables must be adequately secured and have an adequate wire gauge size.</li> </ul> <p style="margin-left: 40px;"><i>Connection Cable Wire Gauge:</i></p> <p style="margin-left: 80px;"><i>1 mm<sup>2</sup> – 2.5 mm<sup>2</sup></i></p> <p style="margin-left: 80px;"><i>17 AWG – 13 AWG</i></p> <ul style="list-style-type: none"> <li>• The power supply of the device must have a suitable disconnection mechanism such as a switch. This disconnection mechanism must be readily accessible in the vicinity of the appliance and marked accordingly as a cut-off mechanism for the appliance.</li> </ul>

## 2.5 Safety During Operation



### WARNING!

#### Avoiding Short-Circuits

Protect the device against all ingress of solid objects or liquids. Ingress presents a risk of electric shock or short-circuiting!

#### Ventilation Slots

Ensure that the ventilation slots are clean and uncovered at all times. Blocked ventilation slots may cause heat to be trapped in the system, resulting in overheating. This may cause your device to malfunction or fail.

#### Appropriate Usage

The device is only deemed to be appropriately used and EMC limits (electromagnetic compatibility) are only deemed to be observed if the chassis cover is properly fitted (thus ensuring that the device is properly cooled, fire-safe, and shielded against electrical, magnetic and electromagnetic fields).



#### Switching the Device Off in the Event of a Malfunction or when Repairs are Required

It is not sufficient to simply switch off the device itself in order to disconnect the power supply. If the device is malfunctioning, or if repairs become necessary, the device must be isolated from all power supplies immediately.

#### **To do so, follow the procedure below:**

- Switch off the device from the unit itself.
- Pull out all power supply plugs.
- Inform the person or department responsible for your electrical installation.
- If your device is connected to an Uninterruptible Power Supply (UPS), it will remain operational even after pulling the UPS power cable from the mains socket. In this case, you will need to shut down your UPS in accordance with the user documentation of your UPS system.

## 2.6 Safety During Maintenance



### WARNING!

When modifying the device in any way, only use components that are approved for use with the system. Failure to comply with this requirement may result in violations of EMC or safety standards and cause the device to malfunction.

When modifying or removing components approved for the system, the force required to remove the components (approx. 60 N) presents a risk of injury to the hands. Information on which components are approved for installation can be obtained from Meinberg Technical Support.

The device must not be opened. Repairs to the device may only be performed by the manufacturer or authorized personnel. Improperly performed repairs expose the user to considerable risk (electric shock, fire hazard).



- Danger from moving parts. Keep away from moving parts.



- Parts of the device may get very hot during operation. Do not touch the surfaces of these! Switch off the device and allow it to cool if necessary before installing or removing any components.



## 2.7 Handling of Batteries



### WARNING!

The lithium battery on the receiver modules has a life of at least ten years. Should it be necessary to replace it, please note the following:

Improper handling of the battery can lead to an explosion or to a leakage of flammable liquids or gases.

- Never short-circuit the battery.
- Never attempt to recharge the battery.
- Never throw the battery into a fire.
- The battery must only be exposed to the barometric pressure range specified by the battery manufacturer.
- The battery must only ever be replaced with one of the same type or a comparable type recommended by the manufacturer. The battery must only be replaced by the manufacturer or an authorized technician.
- Never dispose of the battery in a mechanical crusher or shredder, or in an open fire or furnace.

Please consult your local waste disposal regulations for information on how to dispose of hazardous waste.



### IMPORTANT!

The battery is used to power components such as the RAM and the reserve real-time backup clock for the reference clock.

If the battery voltage drops below 3 V DC, Meinberg recommends having the battery replaced. If the battery voltage drops below the specified minimum, the following behavior may be observed in the reference clock:

- The reference clock may have the wrong date or wrong date upon power-up
- The reference clock repeatedly starts in Cold Boot mode
- Some of the configurations saved for the reference clock may be lost

## 2.8 Cleaning and Care



### ATTENTION!

Never clean the device using liquids! Water ingress is a significant safety risk for the user (e.g., electric shock).

Liquids can cause irreparable damage to the electronics of the device! The ingress of liquids into the device chassis may cause short circuits in the electronic circuitry.

Only clean with a soft, dry cloth. Never use solvents or cleaners.

## 2.9 Prevention of ESD Damage



### ATTENTION!

An ESDS device (electrostatic discharge-sensitive device) is any device at risk of damage or malfunction due to electrostatic discharges (ESD) and thus requires special measures to prevent such damage or malfunction. Systems and modules with ESDS devices usually bear the following symbol:



### Symbol Indicating Devices with ESDS Components

The following measures will help to protect ESDS components from damage and malfunction.

When preparing to dismantle or install devices:

Ground your body (for example, by touching a grounded object) before touching sensitive devices.

Ensure that you wear a grounding strap on your wrist when handling such devices. These straps must in turn be attached to an uncoated, non-conductive metal part of the system.

Use only tools and devices that are free of static electricity.

When transporting devices:

Devices must only be touched or held by the edges. Never touch any pins or conductors on the device.

When dismantling or installing devices:

Avoid coming into contact with persons who are not grounded. Such contact may compromise your connection with the earth conductor and thus also compromise the device's protection from any static charges you may be carrying.

When storing devices:

Always store devices in ESD-proof ("antistatic") bags. These bags must not be damaged in any way. ESD-proof bags that are crumpled or have holes cannot provide effective protection against electrostatic discharges.

ESD-proof bags must have a sufficient electrical resistance and must not be made of conductive metals if the device has a lithium battery fitted on it.

## 2.10 Return of Electrical and Electronic Equipment



### ATTENTION!

**WEEE Directive on Waste Electrical and Electronic Equipment 2012/19/EU**  
(WEEE Waste Electrical and Electronic Equipment)

#### Waste Separation

Product Category: According to the device types listed in Annex I of the WEEE Directive, this product is classified as "IT and Telecommunications Equipment".



This product satisfies the labeling requirements of the WEEE Directive. The product symbol on the left indicates that this electronic product must not be disposed of in domestic waste.

#### Return and Collection Systems

When disposing of your old equipment, please use the national return or collection systems available to you. Alternatively, you may contact Meinberg, who will provide further assistance.

The return of electronic waste may not be accepted if the device is soiled or contaminated in such a way that it potentially presents a risk to human health or safety.

#### Return of Used Batteries

The EU Battery Directive prohibits the disposal of batteries marked with the WEEE trashcan symbol above in household waste.

## 3 The Modular System SyncFire 1200

The SyncFire 1200 system is based on an HP ProLiant series server (HPE ProLiant DL325 Gen10 Server) with a built-in GPS or combined GNSS (GPS/GLONASS/Galileo/BeiDou) reference clock from Meinberg. The various inputs and outputs of the system are accessible via connectors in the rear panel and front panel of the chassis. Details of the components are described below.

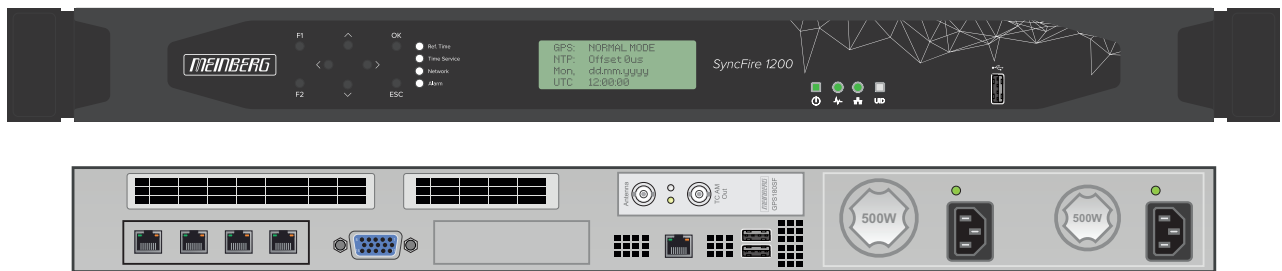

The implemented NTPD distributes the reference time from the used receiver cyclic in the network. Information on the NTPD is monitored on the LC-Display or can be inquired via the network.

The installation of system is very easy for the system/network administrator. The network address, the netmask and the default gateway have to be configured from the front panel of SyncFire 1200. The network address or the equivalent name of system has to be shown to all NTP clients in the TCP/IP network.

As well as NTP the Linux system also supports a number of further network protocols: HTTP(S), FTP, PRP, SSH and Telnet. Because of this remote configuration or status requests can come from any WEB browser.

This access via the network can be deactivated. Changes in the receiver status, errors or other important events are logged either on the local Linux system or on an external SYSLOG-Server. In addition, messages can be sent to a central (monitoring) system via SNMP traps or automatically generated e-mails where they can be recorded.

Furthermore all alarm messages can be displayed by the large display VP100/20/NET that is accessed via network connection. In order to avoid a service interruption several Meinberg NTP servers can be installed in the same network to obtain redundancy.

### Product Features:

- Redundant power supply (hot-plug power supply unit)
- Menu navigation via LC display, 4 x 20 characters
- Up to twelve independent RJ-45 network connections 10/100/1000 MBit/s
- **Max. supported NTP requests/second:**  
Multi-core NTP: up to 1,000,000  
Multi-threading support developed by Meinberg
- The SyncFire 1200 can be configured to operate in cluster mode

## 3.1 Network Configuration Concept

The LANTIME system supports a wide range of different network environments due to its flexible and powerful network configuration concept. A separation between physical and logical ("virtual") interface configurations covers almost all possible requirements for datacenters, telecommunication backhaul networks and industrial network environments.

Each LANTIME server has at least one physical ethernet interface which is provided by the CPU module (lan0). Additional network interfaces can be provided by network expansion cards (LNE or TSU cards) or on backplanes (depending on model). These additional physical interfaces can be used to provide synchronization services to multiple physical network segments, to separate management and synchronization networks or to combine multiple ethernet interfaces to form redundant connections ("bonding"). The 6th generation of LANTIME firmware (LTOS6) can manage up to 99 physical network interfaces as a theoretical maximum.

Configuration of IPv4 and IPv6 addresses is done based on logical interface configurations. Each logical interface is assigned to one physical ethernet port and can be configured to use one IEEE 802.1q VLAN ID. The current firmware version supports up to 99 logical interfaces per server and all of those could be theoretically assigned to a single physical port.

The network ports of TSU modules (for PTP and Hardware-NTP) are not providing this logical interface functionality and are limited, at least in the current firmware version, to one IPv4/IPv6 address and one VLAN ID per physical interface. Redundancy and connectivity to multiple network segments and VLANs can be achieved by adding multiple TSU cards in a system.

For each logical interface the available network services for synchronization (NTP, TIME, ..) and management (HTTP, HTTPS, SSH, SNMP, TELNET, ...) can be enabled/disabled individually. This allows to only provide synchronization on one IP address and remote access the unit for management tasks over a different IP address.

## 3.2 Why to use a Network Time Server?

In principle it is possible to synchronize your computers with time servers on the internet. However, a lot of our customers rely on their own time server in their network environment for security and/or maintainability reasons.

- Particularly in the case of our NTP SERVER you or a responsible person can be notified by mail or SNMP trap if there is a malfunction in your time synchronization.
- The clients on the network do not depend on an active internet connection.
- The clients on the network do not depend on the availability of an external time server.
- A test of other freely available time servers reported that many NTP servers distributed a significantly wrong time, although they were classified as stratum-1 time servers. This is the responsibility of the server's administrators.
- If an internet connection is working properly then NTP can determine and account for the packet transmission delays quite reliable. However, if the internet connection is at its capacity limit, time synchronization can be significantly degraded due to high dispersion in packet transmission delays. Reasons for this may be hacker attacks, which must not address your own network, or new viruses causing a huge flood of emails, like it has already happened in the past.
- An own time server can not easily be compromised out of the internet. At the first moment this sounds trivially, however, there has been a case which really occurred and which caused some concern to the NTP community: A manufacturer of low-cost routers had the IP address of a public NTP server hard coded into the firmware in order to let the routers get their time from that server. Additionally, the implementation of the firmware was faulty, which resulted in a huge flood of NTP queries being sent to the NTP server. This did not even constrain the function of the NTP server, but also caused large costs to the operator due to the huge network traffic. In this case not even the deactivation of the NTP server did help since the faulty routers kept sending request packet even at a higher rate if the NTP server did not respond.

In the United States the U.S. Naval Observatory (USNO) has a similar function to spread the legal time as the PTB in Germany, and also operates publicly available NTP servers for a long time. Those NTP servers are more and more constrained by "bad" clients, which makes the future of the public service questionable. There are already precautions to limit the affect of such clients. Dave Mills, the originator of NTP, cooperates with the USNO and has already adverted this in the NTP news group.

The topics outlined above should provide some arguments to install an own time server, if an accurate time is a requirement for the reliable operation of a local network.

## 4 Before you start

### 4.1 Text and Syntax Conventions

This chapter briefly describes the text and syntax conventions used in this manual.

**Web Interface:** example "Menu Network"

Submenu "Network → Network Interfaces"

Items in Submenu "Network → Network Interfaces → IPv4"

The menu navigation is logically separated by an right arrow (→).

**Directory names / Paths** Example: Lantime configuration file

The directory names and paths are displayed in italics.

#### Code and CLI Commands

```
- cmd/www-upload.htm
```

```
#Program code and CLI commands are displayed in a grey box with monospace font.
```

#### User passwords:

The following characters are currently allowed for user passwords and shared secret:

Allowed character set for both:

```
validchars[] = abcdefghijklmnopqrstuvwxyz  
ABCDEFGHIJKLMNopQRSTUVWXYZ  
0123456789  
=-_:#*?@/+/![]
```

## 4.2 Required Tools

LANTIME IMS SERIES							
	LANTIME M1000	LANTIME M1000S	LANTIME M2000S	LANTIME M3000	LANTIME M3000S	LANTIME M4000	LANTIME M500
Mounting Rackears	TORX T20	TORX T20	TORX T20	TORX T20	TORX T20	TORX T20	X
Mounting DIN rail	X	X	X	X	X	X	Phillips PH1 x 80
Replacing IMS modules	TORX T8	TORX T8	TORX T8	TORX T8	TORX T8	TORX T8	TORX T8
FAN Installation	TORX T8	TORX T8	TORX T8	TORX T8	X	TORX T8 Flat head Screwdriver	X

LANTIME SERIES							
	LANTIME M100	LANTIME M200	LANTIME M300	LANTIME M400	LANTIME M600	LANTIME M900	SyncFire
Mounting Rackears	X	TORX T20	TORX T20	X	TORX T20	TORX T20	X
Mounting DIN rail	Phillips PH1 x 80	X	X	Phillips PH1 x 80	X	X	X
Replacing Modules	X	X	X	X	X	TORX T8	TORX T10



Figure: Required tools from left to right - INBUS 2,5mm, Phillips PH1 x 80, Flat head Screwdriver, TORX T20, TORX T8



### 4.3 Abbreviation List

AFNOR	Association Francaise de Normalisation	MAC	Media Access Control
AC	Alternating Current	MD5	Message-Digest Algorithm 5
ASCII	American Standard Code for Information Interchange	MIB	Management Information Base
BMC	Best Master Clock	MRS	Multi Reference Source
BNC	Bayonet Neill-Conselman connector	MSF	Time signal transmitter in Anthorn, UK
Bps	Bytes per second	NIST	National Institute of Standards and Technology
bps	Bits per second	NMEA	National Marine Electronics Association
CAT5/CAT6/	Category 5/6/7 Cable	NTP	Network Time Protocol
CAT7		NTPD	NTP Daemon
CEST	Central European Summertime	OSV	Original Shipped Version (Firmware)
CET	Central European Time	OUT	Output
CLI	Command Line Interface	P2P	Peer-to-Peer
DB9	D-Subminiature 9-pin	PLC	Programmable Logic Controller
DC	Direct Current	PLL	Phase-Locked Loop
DCF77	A long-wave time signal. D=Deutschland (Germany), C=long wave signal, F=Frankfurt, 77=frequency: 77.5 kHz.	PPM	Pulse per Minute
DHCP	Dynamic Host Configuration Protocol	PRP	Parallel Redundancy Protocol
DNS	Domain Name Server	PPS	Pulse per Second
DSCP	Differentiated Services Code Points	PPH	Pulse per Hour
DST	Daylight Saving Time	PTB	Physikalisch-Technische Bundesanstalt
E1	E-carrier protocol	PTP	Precision Time Protocol
E2E	End-to-end	RAM	Random Access Memory
ETH	Ethernet	RF	Radio Frequency
FTP	File Transfer Protocol	RMC	Remote Monitoring Control
FW	Firmware	RoHS	Restriction of Hazardous Substances Directive
GE / GbE	Gigabit Ethernet	RPS	Redundant Power Supply
GLONASS	GLOBAL NAVIGATION Satellite System	RSC	Redundant Switch Control unit
GND	Ground (Connector)	RX	Receiving Data
GNSS	Global Navigation Satellite System (GPS, GLONASS, Galileo, Beidou)	SBC	Single-Board Computer
GOAL	GPS Optical Antenna Link	SDU	Signal Distribution Unit
GPS	Global Positioning System (USA)	SHA-1	Secure Hash Algorithm 1
GSM	Global System for Mobile Communications	SMB	Subminiature-B
HMI	Human-Machine Interface	SNMP	Simple Network Management Protocol
HP	Horizontal Pitch	SNTP	Simple Network Time Protocol
HPS	High-Performance Synchronization PTP/NTP/SyncE GBit module	SMTP	Simple Mail Transfer Protocol
HSR	High-Availability Seamless Redundancy	SPS	Standard Positioning System
HTTP	Hypertext Transfer Protocol	SSH	Secure SHell network protocol
HTTPS	Hypertext Transfer Protocol Secure	SSU	Synchronization Supply Unit
IEC	International Electrotechnical Commission	SSM	Sync Status Messages
IED	Intelligent Electronic Devices	ST	Straight Tip
IEEE	Institute of Electric and Electronic Engineers	SYSLOG	System Log
IP	Internet Protocol	TACACS	Terminal Access Controller Access Control System
IP20	Ingress Protection Rating 20	TCG	Time Code Generator
IRIG	Inter-Range Instrumentation Group	TCR	Time Code Receiver
LCD	Liquid Crystal Display	T1	Transmission System 1
LED	Light-Emitting Diode	TCP	Transmission Control Protocol
LIU	Line Interface Unit - a module for generating E1/T1 Signals, both MBit/s (framed) and Clock (unframed)	TTL	Transistor-to-Transistor Logic
LNE	Local Network Extension	TX	Data Transmission (Rack) Unit (also RU)
		U	User Datagram Protocol
		UDP	Universal Mobile Telecommunications System
		UMTS	Coordinated Universal Time
		UTC	Virtual Local Area Network
		VLAN	Time signal radio station in Fort Collins, Colorado (USA)
		WWVB	

## 5 Installation of the GPS Antenna



### Danger!

Do not mount the antenna without an effective fall arrester!

**Danger of death from falling!**

- Ensure that you work safely when installing antennas!
- Never work without an effective fall arrester!



### Danger!

Do not work on the antenna system during thunderstorms!

**Danger of death from electric shock!**

- Do not carry out any work on the antenna system or the antenna cable if there is a risk of lightning strike.
- Do not carry out any work on the antenna system if it is not possible to maintain the prescribed safe distance to exposed lines and electrical substations.

### Selecting the Antenna Location

To avoid difficulties with synchronization, select a location that allows for an unobstructed view of the sky so as to ensure that enough satellites can be found. The line of sight between the antenna and satellites should not be obstructed in any way. The antenna must also not be installed under power lines or other electrical lighting or power circuits.

#### Installation Conditions for Optimum Operation:

- clear view of 8° above the horizon or
- clear view towards equator (if clear view of 8° not possible) or
- clear view between 55th north and 55th south parallels (satellite orbits).



### Information:

Problems may arise if all of these views are obstructed, as four satellites must be located to calculate a new position.

## Important Information Regarding Surge Protection

The following illustration is a visual representation of where there is a risk of hazardous voltage surges in the cable route (from antenna to Meinberg system). The examples below explain how you can protect your Meinberg system from these.

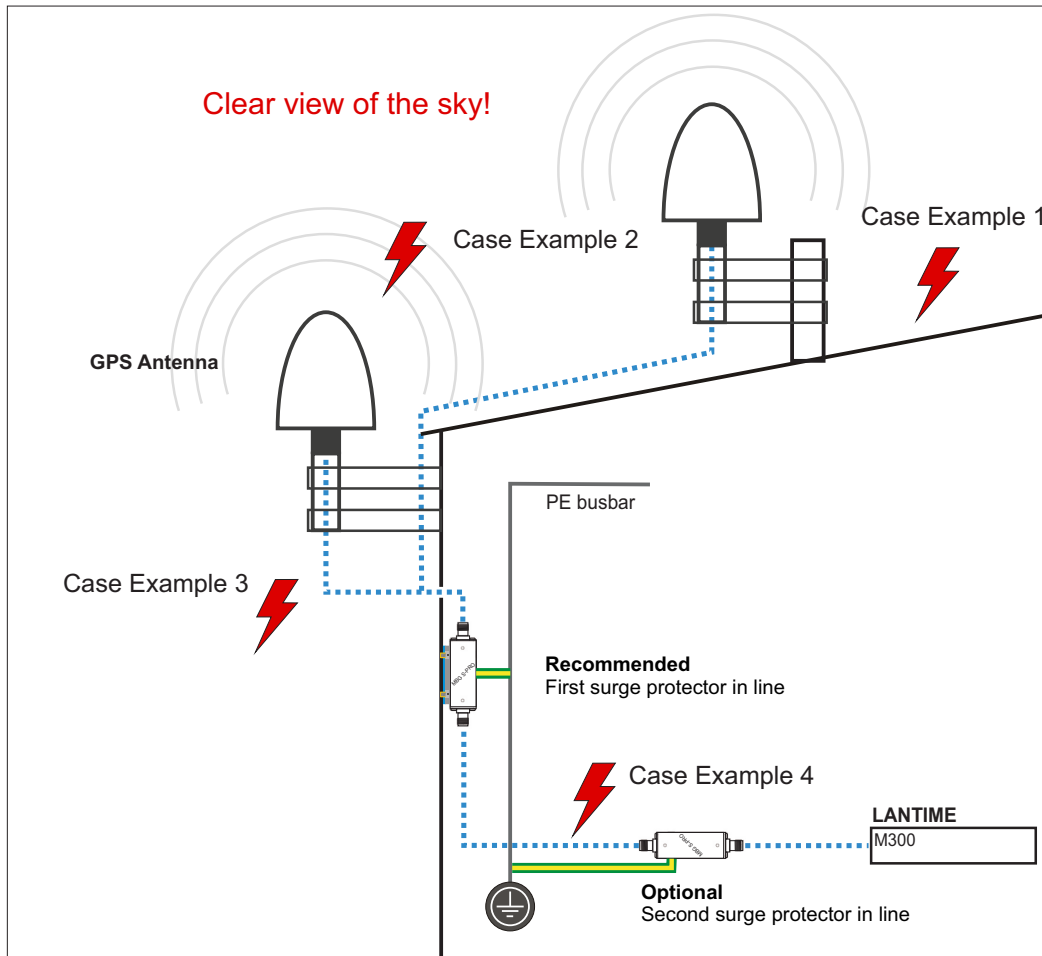

### Case Example 1:

An indirect lightning strike near the antenna or coaxial cable may induce transient voltages ("spikes" or "surges"). These spikes can be carried via the coaxial cable to the inside of the building and consequently to the system's receiver. It is therefore strongly recommended to have the surge protector installed at the point directly after the cable enters the building.

### Case Example 2:

In the event of a direct lightning strike on the antenna, the resultant transient voltage may be discharged via the PE busbar (GNS L1 antenna only). This prevents the transient voltage from being carried to the coaxial cable and subsequently to the system's receiver.

### Case Example 3:

If the length of the coaxial cable between the antenna and point of entry into the building is rather long (e.g., 10 meters), there is a greater risk of transient voltages being introduced into the antenna cable as a result of lightning strike. So the installation of a surge protector immediately after the point of entry into the building is also strongly recommended here.

### Case Example 4:

If the cable leading from the point of entry into the building to the Meinberg system is laid together with other cables (for example in a cable duct alongside high-voltage cables), transient voltages may "leak" into the antenna cable, causing damage to your system. To prevent this, a second surge protector can optionally be installed in the line just before the device.

## Mounting the Antenna

1.

Use the included mounting kit to mount the antenna at a distance of 50 cm from other antennas, either on a vertical pole of a diameter of no more than 60 mm, or directly onto a wall.

The antenna cable should then be connected to the Type-N connector of the antenna. Feed the other end of the cable into the building through the wall.

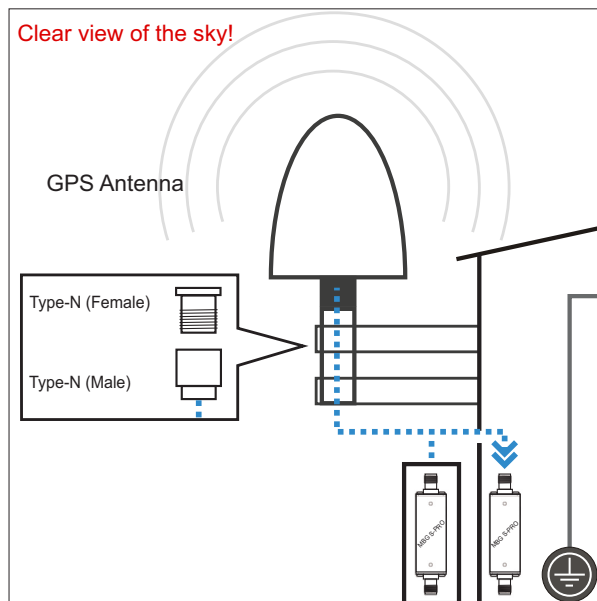

### Information:

Make sure that the maximum cable length is not exceeded when installing the antenna cable between the antenna and receiver. The maximum length will depend on the type of cable used (RG213, RG58) and its attenuation factor.

2.

Voltage surges (e.g., caused by lightning strike) may be transmitted along the antenna cable and cause damage to the receiver. Using a MBG S-PRO surge protector can help to protect your receiver against such surges.

If installed in a waterproof housing, the MBG S-PRO can be installed outdoors. However, Meinberg recommends installing the surge protector indoors—as closely to the entrance point of the antenna cable as possible—in order to minimize the risk of surge damage (such as that caused by lightning strike).

Connect the other end of the antenna cable to the female connector of the surge protector.

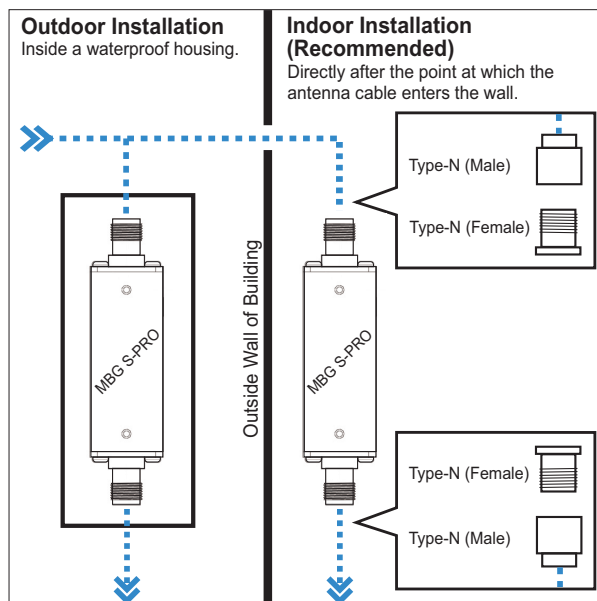

3.

To ground the antenna cable, connect the surge protector to a grounding busbar using a grounding conductor (see illustration).

Once installation is complete, connect the other end of the antenna cable to the surge protector female connector.

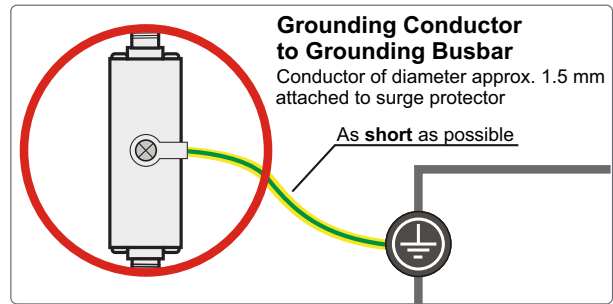

4.

The next step is to connect the supplied coaxial cable from the surge protector to the receiver.

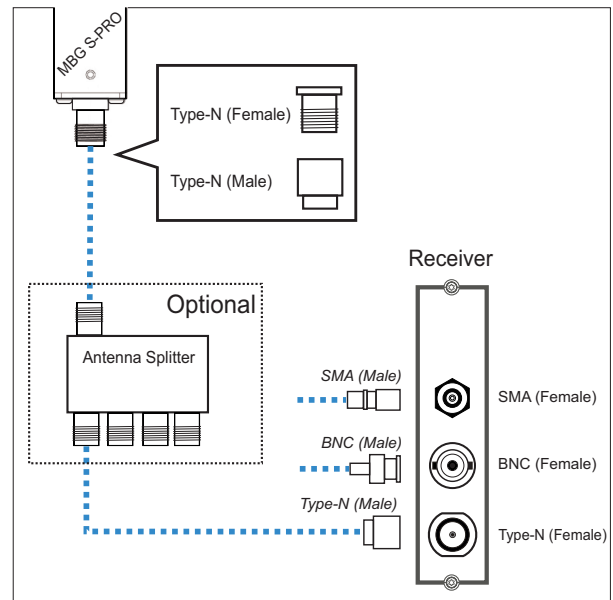

## Optional Antenna Splitter

Multiple receivers can be connected to one antenna using the antenna splitter. When doing so, be aware that the total distance, comprising the cable from the antenna to the splitter, and from there to the receiver, must not exceed the maximum cable length. The splitter may be installed at any location between the surge protector and the receivers.



### Information:

Please note for installation purposes that GNSS L1 components cannot be directly connected to or used with a Meinberg GPS antenna distributor.

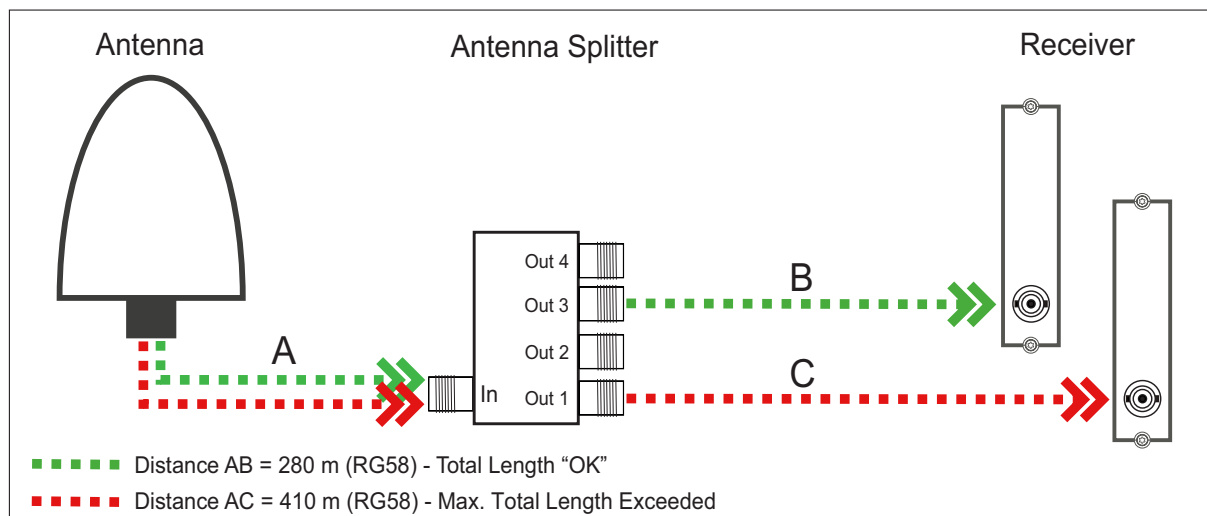

## Compensating for Signal Propagation Delay in the Antenna Cable

To enable the connected receiver to compensate for the signal propagation delay inherent in the antenna cable, you will need to enter either the length of your antenna cable in meters or the offset time in nanoseconds into your receiver.

### Antenna Cable Length (m):

The satellite signal reception is delayed as a result of coaxial cable used.

Cable	Delay	Usage
RG58U	5 ns/m	For GPS and GNS-UC receivers
H155	4 ns/m	For GNS and GNM receivers

The cable length entered (from antenna to receiver) is used by the system to calculate the delay time and to automatically compensate for propagation delay. A value of 20 m is set by default.

When using a different type of coaxial cable, please use the "By Delay" option. You will need to calculate the delay yourself using the information provided in the product specifications provided by the manufacturer of your coaxial cable.

# 6 Technical Appendix: GPS Antenna + Accessories

Physical Dimensions:

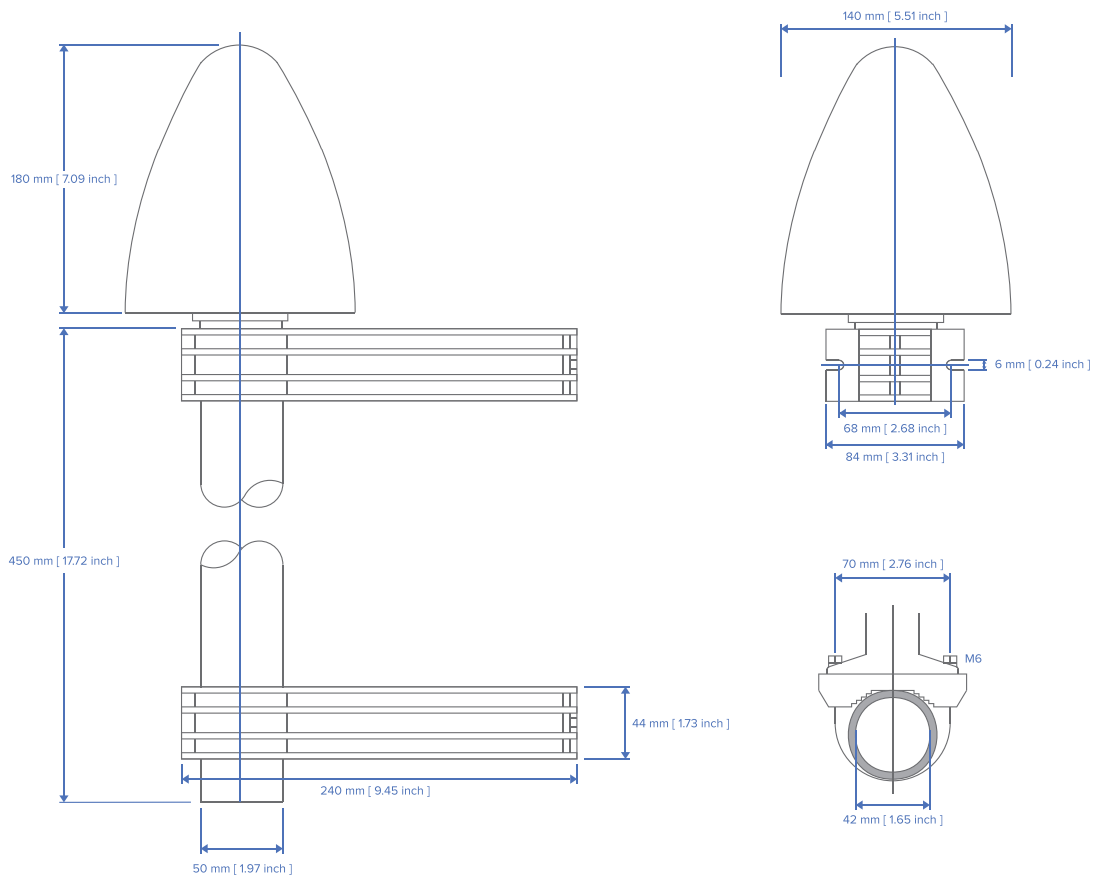

## Specifications:

Power Supply:	15 V, 100 mA (provided via antenna cable)	
Reception Frequency:	1575.42 MHz	
Bandwidth:	9 MHz	
Frequencies:	Mixed Frequency	10 MHz
	IF frequency:	35.4 MHz
Connector:	Type-N Female	
Form Factor:	ABS Plastic Case for Outdoor Installation	
IP Rating:	IP66	
Humidity:	95 %	
Temperature Range:	-60 °C to +80 °C (-76 °F to 176 °F)	
Weight:	1.6 kg (3.53 lbs), including mounting kit	



## 6.1 Technical Specifications: Antenna Cable

The table below shows which coaxial cable types and lengths are supported by Meinberg for each of the receiver types. If you need to purchase a replacement cable at any time, please refer to this table to ensure that you select cable with suitable cutoff frequency and attenuation properties.

Cable Type	Cable Diameter (mm/in)	Attenuation at 100 MHz (db)/100 m/328 ft	Max. Cable Length (m/ft)	Used for Receiver Type
RG58/CU	5/0.2	17	300/984	GPS/GNS-UC/PZF
RG213	10.3/0.41	7	700/2297	GPS/GNS-UC
H155	5.4/0.21	9.1	70/230	GNM/GNS
H2010 Ultraflex	7.3/0.29	5.8	150/492	GNM/GNS

Please refer to the data sheet of the cable in question for further specifications.

## 6.2 Antenna Short Circuit



### Information:

This information only applies to devices with a front display.

If the antenna line is short-circuited, the following message will be shown on the display:

```
Antenna Short-Circuit
Disconnect Power!!!
```

If this message appears, the clock must be switched off and the cause of the problem must be eliminated before the clock can be switched back on. The supply voltage for the antenna/converter unit is around 15 V DC with the antenna connected.

### 6.3 Technical Specifications: MBG S-PRO Surge Protection

Adapter plug with replaceable gas discharge tube for coaxial signal connections.

Connector Type: Type-N connector female/female. The MBG S-PRO set includes a surge protector (Phoenix CN-UB-280DC-BB), a pre-assembled coaxial cable, and a mounting bracket.

The coaxial cable surge protector must be installed on the antenna line. The shielding is grounded using a conductor that is short as possible. The CN-UB-280DC-BB is equipped with two Type-N female connectors and has no dedicated input/output polarity and no preferred installation orientation.



Phoenix CN-UB-280DC-BB

#### Features:

- High RF Performance
- Multiple Strike Capability
- 20 kA Surge Protection
- Bidirectional Protection

<b>Installation Method:</b>	Connector Type-Specific Adapter Plug	
<b>Direction of Action:</b>	Line Shield/Earth Ground	
<b>Maximum Continuous Operating Voltage:</b>	UC (Wire-Ground) 195 V AC	280 V DC
<b>Rated Current:</b>	$I_N$	5 A (25 °C)
<b>Effective Operating Current:</b>	$I_C$ at UC	$\leq 1 \mu\text{A}$
<b>Rated Discharge Current:</b>	$I_n$ (8/20) $\mu\text{s}$ (Core-Earth) $I_n$ (8/20) $\mu\text{s}$ (Core-Shield)	20 kA 20 kA
<b>Total Surge Current:</b>	(8/20) $\mu\text{s}$ (10/350) $\mu\text{s}$	20 kA 2.5 kA

<b>Max. Discharge Current:</b>	$I_{\max} (8/20)\mu s$ Maximum (Core-Shield)	20 kA
<b>Rated Pulse Current:</b>	$I_{an} (10/1000)\mu s$ (Core-Shield)	100 A
<b>Impulse Discharge Current:</b>	$(10/350) \mu s$ , Peak Value $I_{imp}$	2.5 kA
<b>Output Voltage Limit:</b>	At 1 kV/ $\mu s$ (Core-Earth) spike At 1 kV/ $\mu s$ (Core-Earth) spike	$\leq 900$ V $\leq 900$ V
<b>Response Time:</b>	tA (Core-Earth) tA (Core-GND)	$\leq 100$ ns $\leq 100$ ns
<b>Input Attenuation:</b>	aE, asym.	Typically 0.1 dB ( $\leq 1.2$ GHz) Typically 0.2 dB ( $\leq 2.2$ GHz)
<b>Cut-Off Frequency:</b>	$f_g$ (3 dB), asym. (Shield) in 50 $\Omega$ System	$> 3$ GHz
<b>Standing Wave Ratio:</b>	VSWR in a 50 $\Omega$ System	Typically 1.1 ( $\leq 2$ GHz)
<b>Permissible HF Power:</b>	$P_{\max}$ at VSWR = xx (50 $\Omega$ System)	700 W (VSWR = 1.1) 200 W (VSWR = $\infty$ )
<b>Capacitance:</b>	(Core-Earth) Asymmetric (Shield)	Typically 1.5 pF Typically 1.5 pF
<b>Surge Current Resistance:</b>	(Core-Earth)	C1 - 1 kV/500 A C2 - 10 kV/5 kA C3 - 100 A D1 - 2.5 kA
<b>Ambient Temperature:</b>	(During Operation)	-40 °C ... 80 °C
<b>Supported Altitude:</b>		$\leq 2000$ m (above sea level)
<b>IP Rating:</b>		IP55
<b>Housing Material:</b>		Nickel-Plated Brass Colored Nickel
<b>Dimensions:</b>		Height 25 mm, Width 25 mm, Depth 67 mm
<b>Connection Type:</b>	IN OUT	Type-N Connector 50 $\Omega$ Type-N Connector, Female Type-N Connector, Female
<b>Standards/Regulations:</b>		IEC 61643-21 2000 + A1:2008 EN 61643-21 2001 + A1:2009

The original product page of the supplier (see link) of the CN-UB-280DC-BB surge protector is the source of the specifications above. Please refer to the manufacturer's product page at the following link for detailed specifications as well as a variety of product-specific documents:

<https://www.phoenixcontact.com/online/portal/gb/?uri=pxc-oc-itemdetail:pid=2818850>

### 6.3.1 MBG S-PRO: Physical Dimensions

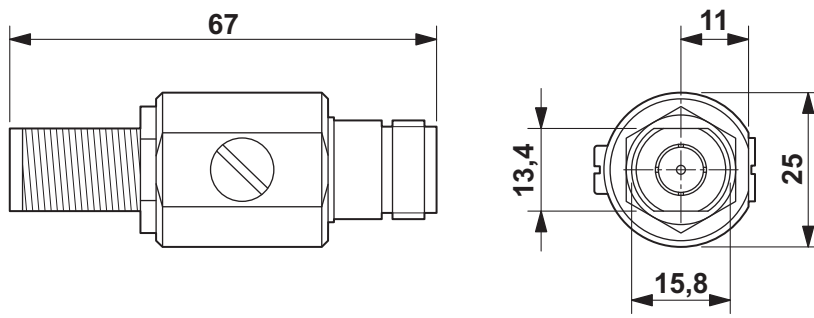

### 6.3.2 Installation and Grounding

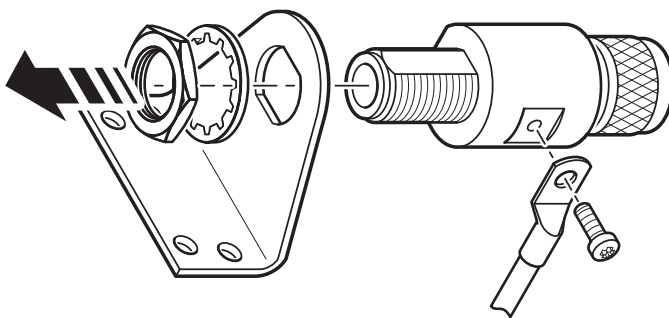

## 7 Information GNSS Antennas

For our combined GPS/GLONASS/Galileo/BeiDou satellite receivers, there are two available antennas, which are designed for different tasks or applications. Our standard accessory includes a Multi GNSS antenna, which is optimized for stationary operation.

### 7.1 Installation of the Multi-GNSS Antenna



#### Danger!

Do not mount the antenna without an effective fall arrester!

Danger of death from falling!

- Ensure that all necessary safety measures are taken when installing an antenna!
- In particular, never work without an effective fall arrester!



#### Danger!

Do not work on the antenna system during thunderstorms!

Danger of death from electric shock!

- Do not carry out any work on the antenna system or the antenna cable if there is a risk of lightning strike.
- Do not carry out any work on the antenna system if it is not possible to maintain the prescribed safe distance to exposed lines and electrical substations.

### Selecting the Antenna Location

To avoid difficulties with synchronization, select a location that allows for an unobstructed view of the sky so as to ensure that enough satellites can be found. The line of sight between the antenna and satellites should not be obstructed in any way. The antenna must also not be installed under power lines or other electrical lighting or power circuits.

**Installation Conditions for Optimum Operation:**

- clear view of 8° above the horizon or
- clear view towards equator (if clear view of 8° not possible) or
- clear view between 55th north and 55th south parallels (satellite orbits).

**Information:**

Problems may arise if all of these views are obstructed, as four satellites must be located to calculate a new position.

**Important Information Regarding Surge Protection**

Information about Meinberg surge protection can be found in the chapter Installation of the GPS Antenna.

**Mounting the Antenna**

1.

Use the included mounting kit to mount the L1 antenna at a distance of 50 cm from other antennas on a vertical pole of a diameter of between 60 mm and 215 mm (2½"-8½").

The antenna cable should then be connected to the Type-N connector of the antenna.

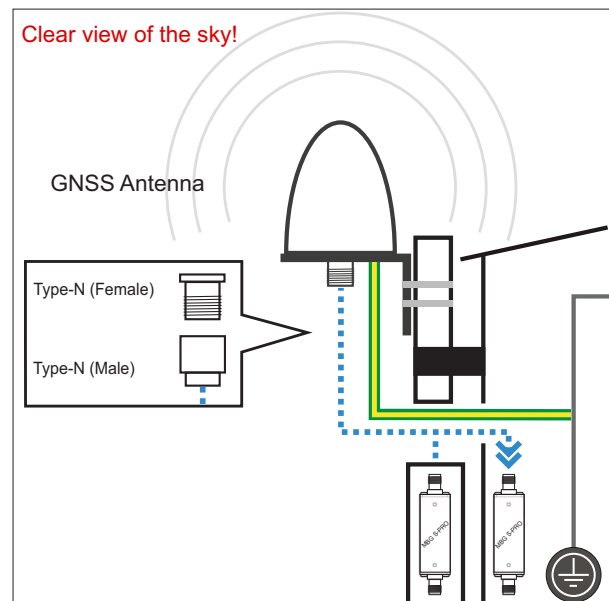
**Information:**

Make sure that the maximum cable length is not exceeded when installing the antenna cable between the antenna and receiver. The maximum length will depend on the type of cable used (RG213, RG58) and its attenuation factor.

2.

Voltage surges (e.g., caused by lightning strike) may be transmitted along the antenna cable and cause damage to the receiver. Using an MBG S-PRO surge protector can help to protect your receiver against such surges.

If installed in a waterproof housing, the MBG S-PRO can be installed outdoors. However, Meinberg recommends installing the surge protector indoors—as closely to the entrance point of the antenna cable as possible—in order to minimize the risk of surge damage (such as that caused by lightning strike).

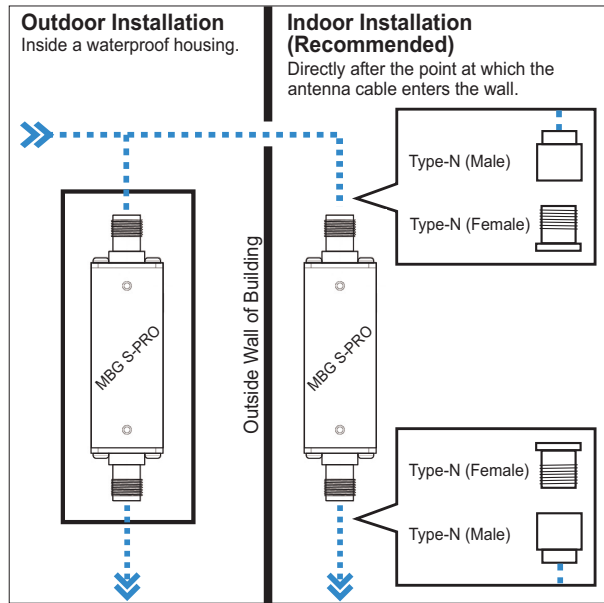

3.

To ground the antenna cable, connect the surge protector to a grounding busbar using a grounding conductor (see illustration).

Once installation is complete, connect the other end of the antenna cable to the surge protector female connector.

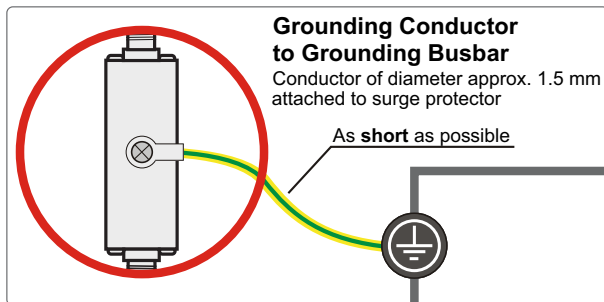

4.

The next step is to connect the supplied coaxial cable from the surge protector to the receiver.

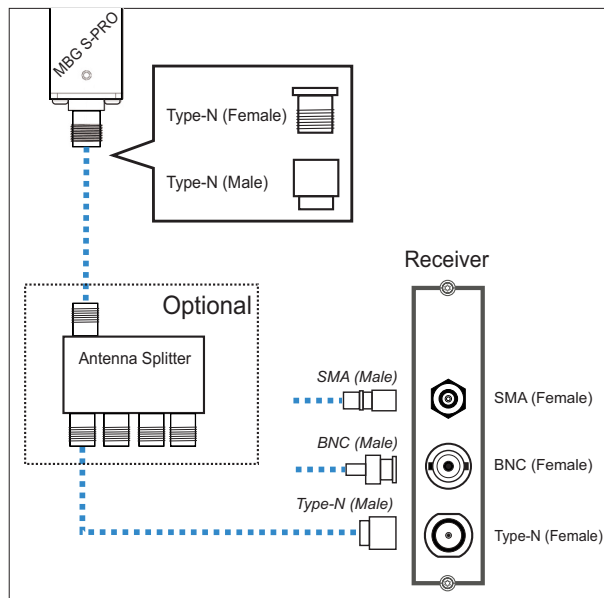

## Optional Antenna Splitter

Multiple receivers can be connected to one antenna using the antenna splitter. When doing so, be aware that the total distance, comprising the cable from the antenna to the splitter, and from there to the receiver, must not exceed the maximum cable length. The splitter may be installed at any location between the surge protector and the receivers.



### Information:

It is not possible to directly connect a Meinberg GPS antenna/converter unit to an L1 antenna splitter.

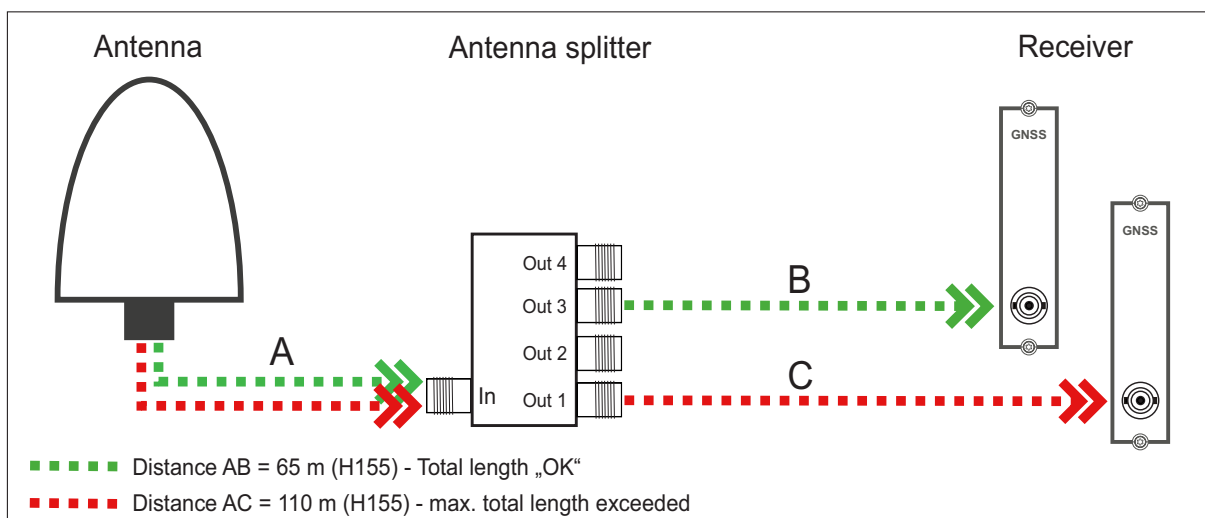

## Compensating for Signal Propagation Delay in the Antenna Cable

To enable the connected receiver to compensate for the signal propagation delay inherent in the antenna cable, you will need to enter either the length of your antenna cable in meters or the offset time in nanoseconds into your receiver.

To do so, go to the web interface of your system to the menu "Clock → Status u. Configuration → Miscellaneous".

### Antenna Cable Length (m):

The satellite signal reception is delayed as a result of coaxial cable used.

Cable	Delay	Usage
RG58U	5 ns/m	For GPS and GNS-UC receivers
H155	4 ns/m	For GNS and GNM receivers

The cable length entered (from antenna to receiver) is used by the system to calculate the delay time and to automatically compensate for propagation delay. A value of 20 m is set by default.

When using a different type of coaxial cable, please use the "By Delay" option. You will need to calculate the delay yourself using the information provided in the product specifications provided by the manufacturer of your coaxial cable.



## 8 Quick Start

When booting the system the following message will be displayed while dots will be counted up in the lower line:.

```
Starting up
please wait ...
....
```

Main Menu will be displayed with some important status informations after booting has finished:

```
NORMAL OPERATION
NTP: Offs: -1us
Tue, 09.02.2021
UTC 10:06:38
```

If the GPS receiver remains asynchronous (Refclock LED is still red after 12 minutes) the number of satellites in view and the good satellites are to check (press buttons ↓, →, →, ↓↓↓ from main menu). The antenna has to be installed without any obstructions to the sky.

```
SU CONSTELLATION
SUs in view: 11
Good SUs : 10
Sel: 00 00 00 00
```

For first time installation enter TCP/IP address, netmask and default gateway. To get an overview of the current configuration press F2 from main menu. Press F2 again to enter SETUP configuration page. Please ask your administrator for proper TCP/IP configuration:

```
-> Interfaces <-
Global Cfg.
Services
Add Interf.
OK
Use Up and Down
to select Port:
lan0:0 #1of4 i
>172.27.00.213
```

Then press 3 times the OK button to change to IPV4 LAN0 configuration page to enter the IP address, netmask and the default gateway:

**NOTE:** These settings are related to the first Ethernet connection (LAN0).

```
>IPv4 Parameter<
IPv6 Parameter
Link Mode
OK
>LAN Address <
LAN Netmask
Gateway
OK
>LAN Address <
LAN Netmask
Gateway
```

After this all further settings can be done via network interface, either by using a WEB browser or a Telnet Session.

**Default user: root**  
**Default password: timeserver**

## 9 Booting the GNSS Receiver

If both the antenna and the power supply have been connected, the system is ready to operate. About 2 minutes after power-up the receiver's oscillator has warmed up and operates with the required accuracy. If the receiver finds valid almanac and ephemeris data in its battery buffered memory and the receiver's position has not changed significantly since its last operation, the receiver can determine which satellites are presently in view. Only a single satellite must be received to synchronize and generate output pulses, so synchronization can be achieved within one minute after power-up.

If the receiver position has changed by more than one hundred kilometers since last operation, the satellites' real elevation and Doppler might not match those values expected by the receiver, and this will force the receiver to start scanning for satellites. This mode is called **Warm Boot** because the receiver can obtain ID numbers of existing satellites from the valid almanac. When the receiver has found four satellites in view it can update its new position and switch to **Normal Operation**. If the almanac has been lost (because the battery has been disconnected) the receiver has to scan for a satellite and read in the current almanac. This mode is called **Cold Boot**. It takes 12 minutes until the new almanac is complete and the system switches to Warm Boot mode, scanning for other satellites.

# 10 Indicators and Function Keys on the Front Panel

LC-Display, 4 x 20 characters

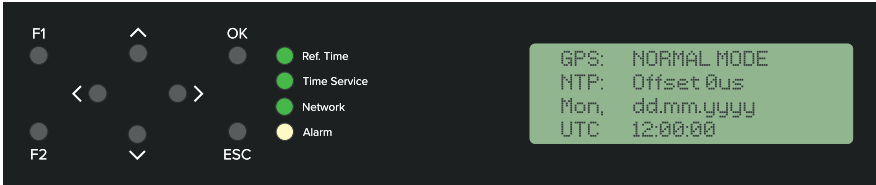

Eight push buttons to set up basic network parameters and to change receiver settings

Four bicolor LEDs showing status of:

- Reference time
- Time service
- Network
- Alarm

Displays and function keys on the front panel

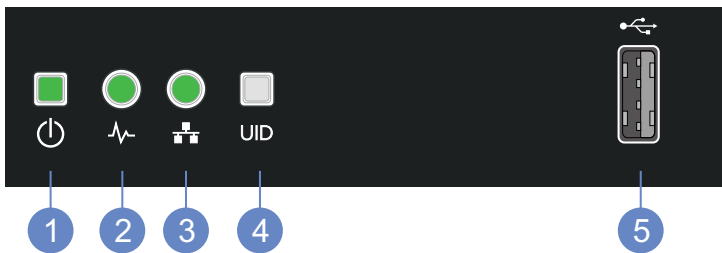

1. Power on / standby button and system power LED
2. Health LED
3. NIC status LED
4. UID button / LED
5. USB 3.0 port

## 10.1 Control Elements

### 1. Power On / Standby-Button / System-Power-LED

When the system is switched off, it can be switched on again by pressing the On/Off button. When the system is operating, pressing the On/Off button will switch off the system.

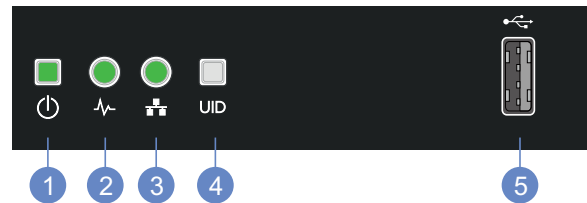

Solid green = System on

Flashing green  
(1 flash per second) = Performing power on sequence

Solid amber = System in standby

Off = No power present

### 2. Health-LED

Solid green = Normal

Flashing green  
(1 flash per second) = iLO is rebooting

Flashing amber = System degraded

Flashing red  
(1 flash per second) = System critical

### 3. NIC-Status-LED

Solid green = Link to network

Flashing green  
(1 flash per second) = Network active

Off = No network activity

### 4. UID-Button / LED

Solid blue = Activated

Flashing blue: 1 flash per second = Remote management or firmware upgrade in progress  
4 flashes per second = iLO manual reboot sequence initiated  
8 flashes per second = iLO manual reboot sequence in progress

Off = Deactivated

### 5. USB 3.0 Port

- Transfer configuration parameters between different LANTIMEs
- Keypad locking for secure using the keypad of the LCD
- Transfer of log files
- Install Software Updates
- Upload and download secure certificates (SSL, SSH) and passwords

# 11 Available Interfaces for Configuration and Monitoring

**SyncFire (SF1000-SC8-33)**  
su-rsf-3.test.mbg\_support.de

✔ Reference Time    🔔 Active Alarms: 1 Critical, 0 Error  
✔ Time Service  
✔ Network  
● Alarm

Logged in as: **root**  
 Access-Level: **Super-User**  
 Firmware-Build: **7.02**

Main
Network
Notification
Security
NTP
System
Statistics
Clock
SyncMon
Docs & Support
Logout

## LANTIME - Main Menu

### General Information

<b>LANTIME</b>	SyncFire (SF1000-SC8-33) [GPS]	<b>Serial Number</b>	053611001160
<b>Contact</b>	Meinberg-Support	<b>Serial Number LANCPU</b>	YLAQ006789
<b>Location</b>	Bad Pyrmont	<b>Uptime</b>	17 days 6:51

### Network Information

<b>Hostname</b>	su-rsf-3	<b>Domain</b>	test.mbg_support.de
<b>LAN Intf 01: IPv4 (lan0:0)</b>	<span style="color: green;">1000FDX</span> 172.27.80.213/16	<b>LAN Intf 01: IPv6 (lan0:0)</b>	<span style="color: green;">1000FDX</span> Not assigned
<b>LAN Intf 02: IPv4 (lan1:1)</b>	<span style="color: green;">1000FDX</span> 192.168.101.113/24	<b>LAN Intf 02: IPv6 (lan1:1)</b>	<span style="color: green;">1000FDX</span> Static: fd00:0:0:101::113/64
<b>LAN Intf 03: IPv4 (lan2:2)</b>	<span style="color: red;">Down</span> Not assigned	<b>LAN Intf 03: IPv6 (lan2:2)</b>	<span style="color: red;">Down</span> Not assigned
<b>LAN Intf 04: IPv4 (lan3:3)</b>	<span style="color: red;">Down</span> Not assigned	<b>LAN Intf 04: IPv6 (lan3:3)</b>	<span style="color: red;">Down</span> Not assigned

### Receiver Information

<b>1. Clock Status</b>	NORMAL OPERATION	<b>Receiver information</b>	sync; 51.9824 9.2259 166m; 9/9SVs; normal operation; warmed up
------------------------	------------------	-----------------------------	--

### NTP Information

<b>NTP Status</b>	Offs.+0us	<b>Date/Time</b>	UTC 08:39:30 Tue, 02/09/2021
<b>Current Load</b>	0.02 NTP req/second	<b>Today's Average</b>	0.02 NTP req/second

### Cluster Information

<b>IF 2 - lan1:1 Cluster State</b>	MASTER
------------------------------------	--------

### Alarms (Details)

<b>Current Errors</b>	<span style="background-color: red; color: white; padding: 2px;">POWER SUPPLY FAILURE</span>
<b>Current Warnings</b>	<span style="background-color: orange; color: white; padding: 2px;">SELF SIGNED CERTIFICATE IN USE</span>

### Last messages

```

2021-01-23 02:10:47 UTC: LANTIME -> Cluster Master changed [Cluster Interface: 1 ]: SLAVE_TO_MASTER
2021-01-23 01:53:22 UTC: LANTIME -> Oscillator Adjusted [CLK: 1 ]
2021-01-23 01:52:21 UTC: LANTIME -> NTP Restart
2021-01-23 01:52:21 UTC: LANTIME -> NTP Sync To GPS
2021-01-23 01:52:21 UTC: LANTIME -> NTP Sync
2021-01-23 01:52:20 UTC: LANTIME -> NTP stratum changed from 16 to 1
2021-01-23 01:52:16 UTC: LANTIME -> Self Signed Certificate In Use
2021-01-23 01:52:16 UTC: LANTIME -> CLK1 Sync
2021-01-23 01:49:58 UTC: LANTIME -> Cluster Master changed [Cluster Interface: 1 ]: MASTER_TO_SLAVE
2021-01-23 01:49:25 UTC: LANTIME -> Fan OK [Fan Module: 2 ]
                
```

<p><b>Meinberg Funkuhren GmbH &amp; Co. KG</b>                  Lange Wand 9                  D - 31812 Bad Pyrmont, Germany</p>	<p><b>Contact</b>                  Phone: +49 (0) 52 81 / 93 09 - 0                  Fax: +49 (0) 52 81 / 93 09 - 230</p>	<p><b>Internet</b>                  Website: <a href="https://www.meinbergglobal.com" style="color: white;">https://www.meinbergglobal.com</a>                  Email: <a href="mailto:info@meinberg.de" style="color: white;">info@meinberg.de</a></p>
--	---	---

The Meinberg SyncFire 1200 runs under LANTIME firmware 7.02 or higher. A detailed description of the web interface and display menu navigation can be found in the current LANTIME firmware manual at: <http://www.mbg.link/doce-fw-ltos>.

All relevant documents can also be found on the supplied USB stick or in the LANTIME web interface under "Docs & Support".

The following menus are available for the SyncFire 1200:

- Network
- Notification
- Security
- NTP
- System
- Statistics
- Clock
- SyncMon
- Docs & Support

Also read the chapter "Security User Guide" for a secure configuration of your SyncFire system in the network. In addition, you will find information about problem solving in the chapters "Troubleshooting & Alarming" and "Support Information".

## 12 Attachment: Technical Information

### 12.1 Technical Specifications SyncFire 1200

**Dimensions:** [W x H x D] 43.46 x 4.29 x 61.49 cm (17.11 x 1.69 x 24.21 in)

**Mounting Depth Rack:** 620 mm

**Height Unit Rack:** 1 U

**19 inch Rackmount:** Yes

**Mounting Cable Depth:** 200 mm (1000 mm rack recommended)

**Weight:** 10 kg (22.05 lb)

#### Electrical data (hot-plug power supply unit)

**Rated Line Voltage:** 100 to 120 V AC (200 to 240 V AC)

**Frequency:** 50/60 Hz

**Effective Power:** 500 W

**Max. Thermal energy:** (for 500 W power supply:)  
2088 kJ/hr (1979 BTU/hr) at 100 V AC  
2016 kJ/hr (1911 BTU/hr) at 200 V AC  
2073 kJ/hr (1965 BTU/hr) at 240 V AC

**Power Supply Configuration:** 2 x hot-plug power supply for redundancy

**Standard Operating Temperature:** 10 ° to 35 °C (50 ° to 95 °F) at sea level with an altitude derating of 1.0 °C per every 305 m (1.8 °F per every 1000 ft) above sea level to a maximum of 3050 m (10,000 ft). Maximum rate of change is 20°C/hr (36°F/hr).

**Non Operating Temperature:** -30 ° to 60 °C (-22 ° to 140 °F). Maximum rate of change is 20°C/hr (36°F/hr).

**Relative Humidity:** Operating  
10 % ... 85 % (non condensing)

Non-operating  
5 to 95 % relative humidity (Rh), 38.7 °C (101.7 °F)  
maximum wet bulb temperature, non-condensing.

**Altitude:** Operating  
3050 m (10,000 ft). This value may be limited by the type and number of options installed. Maximum allowable altitude change rate is 457 m/min (1500 ft/min).

Non-operating  
9144 m (30,000 ft). Maximum allowable altitude change rate is  
457 m/min (1500 ft/min).

*Source: Hewlett Packard documentation: HPE-ProLiant-DL325-Gen10*

## 12.2 Rear Panel Connectors

Name	Type	Signal	Cable
2 x Power supply	100 V - 240V / 500 W		power cord receptacle
GPS Receiver Antenna or combined GPS/GLONASS/Galileo/BeiDou Receiver	BNC female	10 MHz / 35.4 MHz	shielded coaxial line
L1 Antenna	SMA connector	1575.42 +- 10 MHz 1602-1615 MHz	shielded coaxial line
IRIG Time Code (AM)	BNC female	3 V <sub>pp</sub> into 50 Ohm	shielded coaxial line
VGA	15pin D-SUB  16 MB video memory	Integrated video standard Video modes up to 1920 x 1200@60Hz (32 bpp)	shielded data line
2 x USB 3.0	USB connector		
1 x iLO	RJ45	Management Port	shielded data line
4 x LAN Port	RJ45	1 GbE Adapter	shielded data line
<b>Optional</b>			
4 x LAN Ports (add.) or 2 x LAN Ports (add.)	RJ45 SFP Slot	10/100/1000 Mbit/s 10GBASE	shielded data line shielded coax line
Second Receiver GPS Antenna or combined GPS/GLONASS	BNC female	10 MHz / 35.4 MHz	shielded coaxial line
L1 Antenna	SMA	1575.42 +- 10 MHz 1602-1615 MHz	shielded coaxial line
IRIG Time Code (AM)	BNC female	3V <sub>pp</sub> into 50 Ohm	shielded coaxial line



### Caution!

#### Information for ensuring electromagnetic compatibility

All data and signal cables must have sufficient shielding. The use of cable type S/FTP Cat5 or better is recommended. Use of unshielded or badly shielded cables may lead to increased emission of interference and/or reduced fault-tolerance of the device.



## 12.3 1000BASE-T Gigabit Network Port

Signal	1000BASE-T
Data transmission rate:	10/100/1000 Mbit/s
Connection Type:	8P8C (RJ45)
Cable:	Copper twisted pair
Duplex Modes:	Half/Full/Autonegotiaton

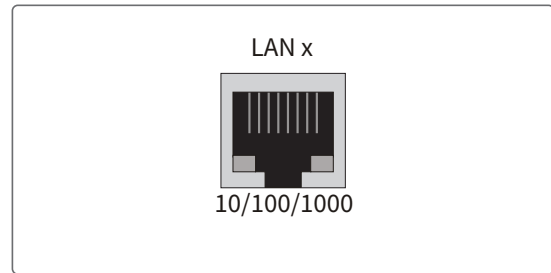

## 12.4 10 Gigabit SFP+

Transceiver Interface Type	SFP+
Bus Interface:	PCI Express v1.1, x8
Network:	10 Gigabit Ethernet
Power consumption:	Dual Port 10GBase-SR, typ. 10 W, max. 10.7 W
	Dual Port SFP+ Twinax typ. 7.9 W, max. 8.6 W
Operating Temperature:	0 - 55 °C

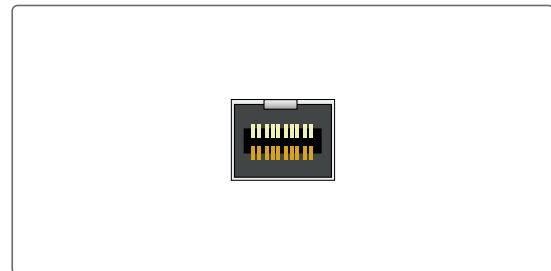

## 12.5 Antenna Input: GPS Reference Clock

**Antenna Input**      Antenna Circuit, Galvanically Isolated

**Dielectric Strength:** 1000 V

**Receiver Type:** 12-Channel GPS Receiver

**Signal Support:** L1 C/A (1575.42 MHz)

### Mixing Frequency

Reference Clock to Antenna  
(GPS Converter): 10 MHz <sup>1</sup>

### Intermediate Frequency

Antenna (GPS Converter)  
to Reference Clock: 35.4 MHz <sup>1</sup>

<sup>1</sup> These frequencies are transferred via the antenna cable

### Power Requirements

**of the Antenna:** 15 V, 100 mA (Via Antenna Cable)

**Connection Type:** BNC Female/Type-N Female

**Cable Type:** Coaxial Cable, Shielded

**Cable Length:** Max. 300 m to RG58,  
Max. 700 m to RG213

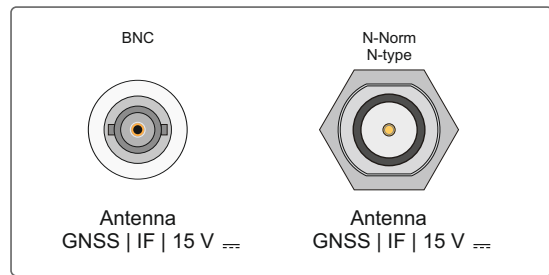

## Danger!

Do not work on the antenna system during thunderstorms!

**Danger of death from electric shock!**

- Do not carry out any work on the antenna system or the antenna cable if there is a risk of lightning strike.
- Do not carry out any work on the antenna system if it is not possible to maintain the prescribed safe distance to exposed lines and electrical substations.



## 12.6 Antenna Input: GNSS Reference Clock

<b>Antenna Type:</b>	Multi GNSS L1 Antenna with Integrated Lightning Protection
<b>Receiver Type:</b>	72-Channel Receiver GPS/GLONASS/Galileo/BeiDou
<b>Signal Support:</b>	<p>GPS: L1 C/A (1575.42 MHz)</p> <p>Galileo: E1-B/C (1575.42 MHz)</p> <p>BeiDou: B1I (1561.098 MHz)</p> <p>GLONASS: L1OF (1602 MHz + <math>k \cdot 562.5</math> kHz)</p> <p>where <math>k</math> represents the channel number (in the range -7 to 6) within the corresponding GLONASS frequency band</p>
<b>Signal Gain:</b>	40 dB
<b>Antenna Gain:</b>	$\geq 3.5$ dBic / $\geq 3$ dBic
<b>DC Voltage:</b>	5 V (Power Supply via Antenna Cable)
<b>DC Current:</b>	Max. 100 mA
<b>Rated Impedance:</b>	50 Ohm
<b>Connection Type:</b>	SMA Female
<b>Cable:</b>	Coaxial Cable, Shielded
<b>Cable Length:</b>	Max. 70 m with Belden H155 Coaxial Cable

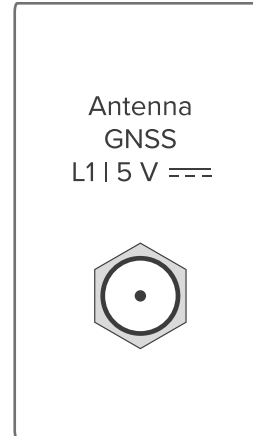

### Danger!

Do not work on the antenna system during thunderstorms!

**Danger of death from electric shock!**

- Do not carry out any work on the antenna system or the antenna cable if there is a risk of lightning strike.
- Do not carry out any work on the antenna system if it is not possible to maintain the prescribed safe distance to exposed lines and electrical substations.



## 12.7 Time Code AM Output

<b>Carrier frequency:</b>	1 kHz (IRIG-B)
<b>Signal outputs:</b>	Unbalanced sine wave-signal: 3 V <sub>pp</sub> (MARK) 1 V <sub>pp</sub> (SPACE) into 50 Ohm
<b>Connector:</b>	BNC, female
<b>Cable:</b>	shielded coax line



## 13 RoHS and WEEE

### Compliance with EU Directive 2011/65/EU (RoHS)

We hereby declare that this product is compliant with the European Union Directive 2011/65/EU and its delegated directive 2015/863/EU "Restrictions of Hazardous Substances in Electrical and Electronic Equipment". We ensure that electrical and electronic products sold in the EU do not contain lead, cadmium, mercury, hexavalent chromium, polybrominated biphenyls (PBBs), polybrominated diphenyl ethers (PBDEs), bis(2-ethylhexyl)phthalat (DEHP), benzyl butyl phthalate (BBP), dibutyl phthalate (DBP), or diisobutyl phthalate (DIBP) above the legal limits.



### WEEE status of the product

This product is handled as a B2B (Business to Business) category product. To ensure that the product is disposed of in a WEEE-compliant fashion, it must be returned to the manufacturer. Any transportation expenses for returning this product (at end-of-life) must be covered by the end user, while Meinberg will bear the costs for the waste disposal itself.



# 14 Declaration of Conformity

## Konformitätserklärung

Doc ID: SyncFire 1200-August 8, 2022

**Hersteller** Meinberg Funkuhren GmbH & Co. KG  
*Manufacturer* Lange Wand 9, D-31812 Bad Pyrmont

erklärt in alleiniger Verantwortung, dass das Produkt,  
*declares under its sole responsibility, that the product*

**Produktbezeichnung** SyncFire 1200  
*Product Designation*

auf das sich diese Erklärung bezieht, mit den folgenden Normen und Richtlinien übereinstimmt:  
*to which this declaration relates is in conformity with the following standards and provisions of the directives:*

---

RED – Richtlinie <i>RED Directive</i>	ETSI EN 303 413 V1.1.1 (2017-06)
--	----------------------------------

2014/53/EU

---

EMV – Richtlinie <i>EMC Directive</i>	ETSI EN 301 489-1 V2.2.3 (2019-11) ETSI EN 301 489-19 V2.1.1 (2019-04) DIN EN 55032:2015
--	--

2014/30/EU  
DIN EN 55024:2010 + A1:2015  
DIN EN 61000-3-2:2019  
DIN EN 61000-3-3:2013 + A1:2019

---

Niederspannungsrichtlinie <i>Low-voltage Directive</i>	DIN EN 60950-1:2006 + A11:2009 + A1:2010 + A12:2011 + AC:2011 + A2:2013 DIN EN 62368-1:2014 + A11:2017
---	--

2014/35/EU  
DIN EN 62368-1:2014 + A11:2017  
DIN EN 62479:2010

---

RoHS – Richtlinie <i>RoHS Directive</i>	DIN EN IEC 63000:2018
--	-----------------------

2011/65/EU + 2015/863/EU

---

Ökodesign – Richtlinie <i>Ecodesign Directive</i>	ETSI EN 303 470 V1.1.1 (2019-03)
--	----------------------------------

2009/125/EC

---

Bad Pyrmont, August 8, 2022

  
Stephan Meinberg  
Production Manager





SyncFire-1200\_080822