



The Synchronization Experts.



TECHNICAL REFERENCE

microSync

RX311/AD10DC20

17th June 2020

Meinberg Funkuhren GmbH & Co. KG

Table of Contents

1	Imprint	1
2	microSync Introduction	2
3	Technical Specifications microSync Chassis	3
4	Important Safety Information	4
4.1	Important Safety Instructions and Protective Measures	4
4.2	Used Symbols	5
4.3	Security during Installation	7
4.4	Protective Conductor- / Ground-Terminal	10
4.5	Safety during Operation	10
4.6	Safety during Maintenance	11
4.7	Handling Batteries	11
4.8	Cleaning and Care	12
4.9	Prevention of ESD Damage	12
4.10	Return of Electrical and Electronic Equipment	13
5	microSync RX311/AD10DC20 Connectors	14
5.1	AC/DC Power Supply	14
5.2	GPS Antenna	17
5.3	Programmable pulse output	18
5.4	Pulse Per Second Input	19
5.5	10 MHz Input	19
5.6	RS-232 COMx Timestring	19
5.7	Status Indicators	20
5.8	USB Interface	21
5.9	LAN Network Interfaces	21
5.10	DMC X2 Terminal Connector	22
5.11	Fiber Optic – Programmable pulse Output	23
5.12	DMC X1 Terminal Connector	24
6	GNSS Satellite Navigation	26
6.1	Time Zone and Daylight Saving	27
7	Mounting the GPS Antenna	28
7.1	Antenna Cable:	29
7.2	Antenna Assembly with Surge Voltage Protection	30
8	Starting of Operation	31
8.1	Establishing a Network Connection	32
8.1.1	Connecting with the Network Configuration Wizard	33
9	Technical Appendix	34
9.1	Technical Specifications GPS Receiver	34
9.2	Configuration Options	36
9.3	Protocols and Profiles	36
9.4	Compliances	36
10	RoHS and WEEE	37
11	Declaration of Conformity	38

1 Imprint

Meinberg Funkuhren GmbH & Co. KG
Lange Wand 9, 31812 Bad Pyrmont / Germany

Phone: + 49 (0) 52 81 / 93 09 - 0
Fax: + 49 (0) 52 81 / 93 09 - 230

Internet: <https://www.meinbergglobal.com>
Mail: info@meinberg.de

Date: 2020-06-17

Manual
Version: 1.01

2 microSync Introduction

microSync is a multipurpose synchronization solution with compact design and high performance. The microSync system provides multiple output signals and allows synchronization of both NTP clients and PTP slaves.

The device has four 100/1000 MBit network interfaces and can provide both, optical and electrical network connections by using SFP modules. It is possible to use different receiver variants, e.g. the 72-channel GNSS receiver for GPS, Galileo, GLONASS and BeiDou.

The sync optimized operating system supports NTP, PTP IEEE 1588 and a variety of protocols for management tasks.

Product Highlights

- Powerful IEEE 1588 PTP Time Server incl. IEC/IEEE 61850-9-3 & IEEE C.37.238
- High performance (S)NTP server
- Redundant power supply
- Different Oscillator options for advanced holdover performance
- Meinberg Device Manager for configuration and status monitoring
- Three-year manufacturer's warranty
- Unlimited technical support including firmware updates

3 Technical Specifications microSync Chassis

Protection Rating:	IP30
Ambient Temperature:	-20 ... 55 °C
Storage Temperature:	-30 ... 70 °C
Humidity:	5% to 95% (non-condensing) @ 40 °C
Operating Altitude:	up to 4,000 m (13,123 ft) above sea level
Atmospheric Pressure:	615 to 1,600 hPa

Physical Dimensions:

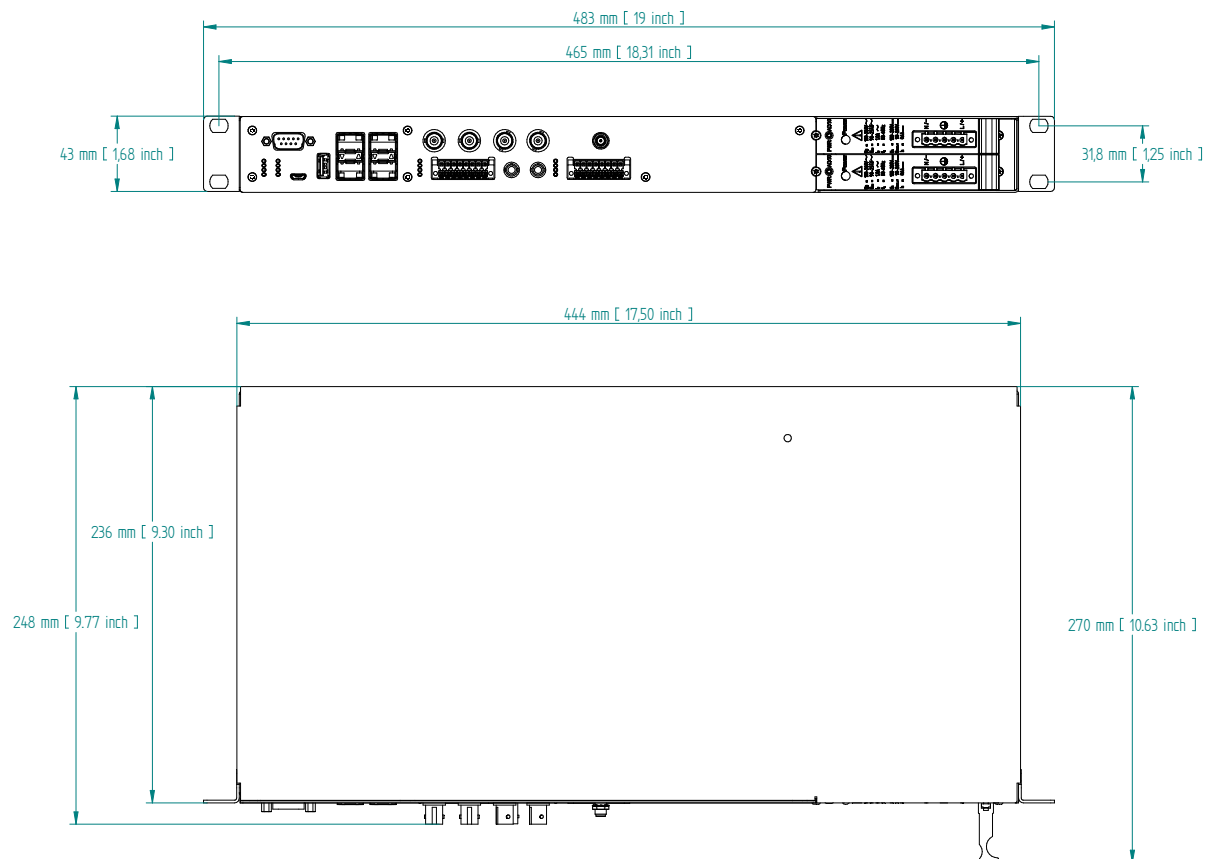

4 Important Safety Information

4.1 Important Safety Instructions and Protective Measures

The following safety instructions must be respected in all operating and installation phases of the device. Non-observance of safety instructions, or rather special warnings and operating instructions in product manuals, violates safety standards, manufacturer instructions and proper usage of the device. Meinberg Funkuhren shall not be responsible for any damage arising due to non-observance of these regulations.



Depending on your device or the installed options some information is not valid for your device.



The device satisfies the requirements of the following EU regulations: EMC-Directive, Low Voltage Directive, RoHS Directive and - if applicable - the Radio Equipment Directive.

If a procedure is marked with the following signal words, you may only continue, if you have understood and fulfilled all requirements. In this documentation dangers and indications are classified and illustrated as follows:



DANGER!

The signal word indicates an imminently hazardous situation with a high risk level . This notice draws attention to an operating procedure or similar proceedings, of which a non-observance may result in serious personal injury or death .



WARNING!

The signal word indicates a hazard with a medium risk gradient . This notice draws attention to an operating procedure, a procedure or the like which, if not followed, can lead to serious injuries , possibly resulting in death .



CAUTION!

The signal word indicates a hazard with a low risk gradient . This notice draws attention to an operating procedure, a procedure or the like which, if not followed, can lead to minor injuries .















ATTENTION!

This notice draws attention to an operating procedure, a procedure or the like which, if not followed, can cause damage to the product or loss of important data .

4.2 Used Symbols

The following symbols and pictograms are used in this manual. To illustrate the source of danger, pictograms are used, which can occur in all hazard classes.

Symbol	Beschreibung / Description
	IEC 60417-5031 Gleichstrom / <i>Direct current</i>
	IEC 60417-5032 Wechselstrom / <i>Alternating current</i>
	IEC 60417-5017 Erdungsanschluss / <i>Earth (ground) terminal</i>
	IEC 60417-5019 Schutzleiteranschluss / <i>Protective earth (ground) terminal</i>
	ISO 7000-0434A Vorsicht / <i>Caution</i>
	IEC 60417-6042 Vorsicht, Risiko eines elektrischen Schlages / <i>Caution, risk of electric shock</i>
	IEC 60417-5041 Vorsicht, heiße Oberfläche / <i>Caution, hot surface</i>
	IEC 60417-6056 Vorsicht, Gefährlich sich bewegende Teile / <i>Caution, moving fan blades</i>
	IEC 60417-6172 Trennen Sie alle Netzstecker / <i>Disconnection, all power plugs</i>
	IEC 60417-5134 Elektrostatisch gefährdete Bauteile / <i>Electrostatic Sensitive Devices</i>
	IEC 60417-6222 Information generell / <i>Information general</i>
	2012/19/EU Dieses Produkt fällt unter die B2B Kategorie. Zur Entsorgung muss es an den Hersteller übergeben werden. <i>This product is handled as a B2B category product. In order to secure a WEEE compliant waste disposal it has to be returned to the manufacturer.</i>

The manuals for a product are included in the scope of delivery of the device on a USB stick. The manuals can also be obtained via the Internet. Enter www.meinbergglobal.com into your browser, then enter the corresponding device name in the search field at the top.



This manual contains important safety instructions for the installation and operation of the device. Please read this manual completely before using the unit.

This device may only be used for the purpose described in this manual. In particular, the given limits of the device must be observed. The safety of the installation in which the unit is integrated is the responsibility of the installer!

Non-observance of these instructions can lead to a reduction in the safety of this device!

Please keep this manual in a safe place.

This manual is intended exclusively for electricians or persons trained by an electrician who are familiar with the applicable national standards and safety rules. Installation, commissioning and operation of this device may only be carried out by qualified personnel.

4.3 Security during Installation



WARNING!

Preparing for Commissioning

This built-in unit, has been designed and examined according to the requirements of the standard IEC 62368-1 "Audio/video, information and communication technology equipment - Part 1: Safety requirements".

When the built-in unit is used in a terminal (e.g., housing cabinet), additional requirements according to Standard IEC 62368-1 must be observed and complied with. In particular, the general requirements and the safety of electrical equipment (such as IEC, VDE, DIN, ANSI) as well as the applicable national standards are to be observed.

The device has been developed for use in the industrial sector as well as in residential areas and can only be used in such environments. For environments with higher levels of soiling, additional measures, e.g. Installation in an air-conditioned control cabinet required.

Transport, Unpacking, Installation

If the unit is brought into the operating room from a cold environment, condensation may occur, wait until the unit is temperature-controlled and absolutely dry before operating it.

When unpacking, setting up, and before operating the equipment, be sure to read the information on the hardware installation and the specifications of the equipment. These include, for example, dimensions, electrical characteristics, and necessary ambient and climatic conditions, etc.

The fire protection must be ensured in the installed state.

For mounting, the housing must not be damaged. No holes may be drilled in the housing.

For safety reasons, the device with the highest mass should be installed in the lowest position of the rack. Other devices must be placed from the bottom to the top.

The device must be protected against mechanical stress such as vibration or shock.



Connecting Data Cables

During a thunderstorm, data transmission lines must not be connected or disconnected (risk of lightning).

When wiring the devices, the cables must be connected or disconnected in the order of the arrangement described in the user documentation accompanying the device. Always attach all cables to the plug during connection and removal. Never pull the cable itself. Pulling the cable can cause the cables to disconnect from the plug.

Install the cables in way that they do not constitute a hazard (danger of tripping) and are not damaged, i.e. kinked.

Connecting Power Supply

This equipment is operated at a hazardous voltage. Non-observance of the safety instructions in this manual may result in serious personal injury or property damage.

Before connecting to the power supply, a grounding cable must be connected to the earth connection of the device.

Before operation, check that all cables and lines work properly and are undamaged. Pay particular attention to the facts that the cables do not have kinks or that they are not too short around corners, and no objects are placed on the cables. Also make sure that all connections are secure.

Faulty shielding or cabling will endanger your health (electrical shock) and may destroy other equipment.

Ensure that all necessary safety precautions have been taken. Make all connections to a unit before turning on the power. Observe the safety instructions on the device (see safety symbols).

The metal housing of the device is grounded. It must be ensured that enough air and creepage distances to neighboring voltage-carrying parts are provided during assembly in the control cabinet and no short circuits are caused.

In the case of malfunctions or servicing (e.g. in the event of a damaged housing or power cable or when fluids or foreign objects enter), the current flow can be interrupted. Questions about the house installation, need to be clarified with your house administration.

The power supply should be connected with a short, low-inductance line.

AC Power Supply	DC Power Supply
<ul style="list-style-type: none"> • The device is a device of protection class 1 and may only be connected to a grounded outlet (TN system). • For safe operation, the device must be protected by an installation fuse of max. 16 A and equipped with a residual current circuit breaker in accordance with the applicable national standards. • The unit must always be disconnected from the mains and not from the appliance. • Devices with mains plugs are equipped with a safety-tested mains cable of the country of use and may only be connected to a grounded shockproof socket, otherwise electric shock may occur. • Make sure that the mains socket on the appliance or the mains socket of the house installation is freely accessible to the user so that the mains cable can be pulled out of the socket in case of emergency. 	<ul style="list-style-type: none"> • Outside the assembly group the device must be disconnectable from the power supply in accordance with the provisions of IEC 62368-1 (e.g. by the primary line protection). • Installation and disassembly of the power supply plug is only permitted if the assembly group is switched off (e.g. by the primary line protection). • The supply lines must be adequately secured and dimensioned. <p style="text-align: center;"><i>Connection Cross Section:</i> $1 \text{ mm}^2 - 2.5 \text{ mm}^2$ 17 AWG – 13 AWG</p> <ul style="list-style-type: none"> • The device must be supplied with a suitable disconnecter (switch). The separation device must be easily accessible, placed near the device and marked as a separation device for the unit.

4.4 Protective Conductor- / Ground-Terminal



ATTENTION!



In order to ensure safe operation and to meet the requirements of IEC 62368-1, the device must be correctly connected to the protective earth conductor via the protective earth connection terminal.



If an external earth connection is provided on the housing, it must be connected to the equipotential bonding rail (grounding rail). The mounting parts (without cable) are not included in the scope of delivery.

Note:

Please use a grounding cable $\geq 1.5 \text{ mm}^2$
Always pay attention to a correct crimp connection!

4.5 Safety during Operation



WARNING!

Avoiding Short-Circuits

Make sure not to get any objects or liquids inside the unit. Electric shock or short circuit could result.

Ventilation Slots

Make sure that the ventilation slots are not covered or dusty, as there is a danger of overheating during operation. Disturbances during operation can result.

Normal Operation

The normal operation and the observance of the EMC limits (electromagnetic compatibility) are only ensured if the housing cover is properly installed and when the doors are closed (cooling, fire protection, shielding against electrical, magnetic and electromagnetic fields).



Switch off in fault / service case

By switching off, the devices are not disconnected from the power supply. In the event of a fault or service case, the devices must be immediately disconnected from all power supplies.

Follow the steps below:

- Switch off the device
- Disconnect all power plugs
- Inform the service
- Devices that are connected via one or more uninterruptible power supplies (UPS) remain operational even when the UPS power cord is disconnected. Therefore, you must put the UPS out of operation according to the documentation of the corresponding user documentation.

4.6 Safety during Maintenance



WARNING!

When you are expanding the device, use only device parts that are approved for the system. Non-observance may result in injury to the EMC or safety standards and cause malfunction of the device.

If device parts, which are released for the system, are extended or removed there may be a risk of injury in the area of the hands, due to the pull-out forces (approx. 60 N).

The service informs you which device parts may be installed.

The device must not be opened, repairs to the device may only be carried out by the manufacturer or by authorized personnel. Improper repairs can result in considerable danger to the user (electric shock, fire hazard).

Unauthorized opening of the device or of individual parts of the device can also lead to considerable risks for the user and result in a loss of warranty as well as an exclusion of liability.



- Danger due to moving parts - keep away from moving parts.



- Device parts can become very hot during operation. Do not touch these surfaces! If necessary, switch off the unit before installing or removing any equipment, and allow it to cool down.

4.7 Handling Batteries



CAUTION!

The lithium battery on the receiver modules has a service life of at least 10 years. If an exchange is necessary, the following notes must be observed:

The device is equipped with a lithium battery. The battery must not be short-circuited or recharged. Replacement of the lithium battery may only be carried out by the manufacturer or authorized personnel.

Risk of explosion if the battery is not replaced correctly. Replace only with the same or equivalent type recommended by the manufacturer.

When disposing used batteries, observe the local regulations for the disposal of hazardous waste.

4.8 Cleaning and Care



ATTENTION!

Do not wet clean the appliance! Penetrating water can cause considerable dangers to the user (e.g., electric shock).

Liquid can destroy the electronics of the device! Liquid penetrates into the housing of the device and can cause a short circuit of the electronics.

Only clean with a soft, dry cloth. Never use solvents or cleaners.

4.9 Prevention of ESD Damage



ATTENTION!

The designation ESD (Electrostatic Sensitive Devices) refers to measures which are used to protect electrostatically endangered components from electrostatic discharge and thus to prevent destruction. Systems and assemblies with electrostatically endangered components usually have the following characteristics:



Indicator for assemblies with electrostatic endangered components

The following measures protect electrostatically endangered components from destruction:

Prepare removal and installation of assemblies

Unload yourself (for example, by touching a grounded object) before touching assemblies.

Ensure that you wear a grounding strap on the wrist when working with such assemblies, which you attach to an unpainted, non-conductive metal part of the system.

Use only tools and devices that are free from static electricity.

Transporting Assemblies

Assemblies may only be touched at the edge. Do not touch any pins or conductors on assemblies.

Installing and Removing Assemblies

Do not touch persons who are not grounded while removing or installing components. This could result in a loss of grounding protection from your electrostatic discharge.

Storing Assemblies

Always keep assemblies in ESD protective covers. These protective covers must be undamaged. ESD protective covers, which are extremely wrinkled or even have holes, no longer protect against electrostatic discharge.

ESD protective covers must not be low-resistance and metallically conductive if a lithium battery is installed on the assembly.

4.10 Return of Electrical and Electronic Equipment



ATTENTION!

WEEE Directive on Waste Electrical and Electronic Equipment 2012/19 / EU
(WEEE Waste Electrical and Electronic Equipment)

Separate Collection

Product Category: According to the device types listed in the WEEE Directive, Appendix 1, this product is classified as an IT and communication device.



This product meets the labeling requirements of the WEEE Directive. The product symbol on the left indicates that this electronic product must not be disposed of in domestic waste.

Return and Collection Systems

For returning your old equipment, please use the country-specific return and collection systems available to you or contact Meinberg.

The withdrawal may be refused in the case of waste equipment which presents a risk to human health or safety due to contamination during use.

Return of used Batteries

Batteries marked with one of the following symbols may not be disposed of together with the household waste according to the EU Directive.

5 microSync RX311/AD10DC20 Connectors

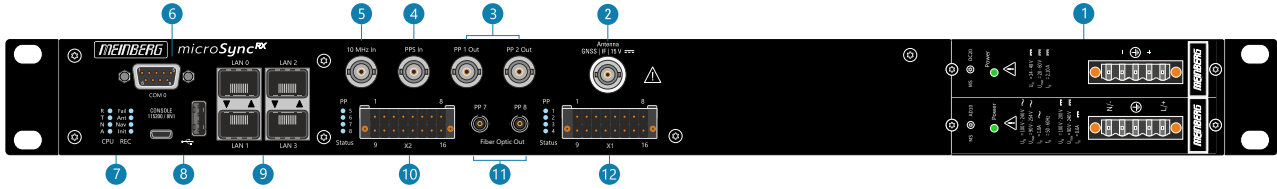

5.1 AC/DC Power Supply



Hotplug

It is possible to remove or install power supplies from the system housing during operation.

Required Tools

- Slot screwdriver 0.4mm thick, 2,5mm wide
- Screwdriver Torx TR8x60

Hints for Hot-Plug compatible Power Supplies

Replacing the power supply unit

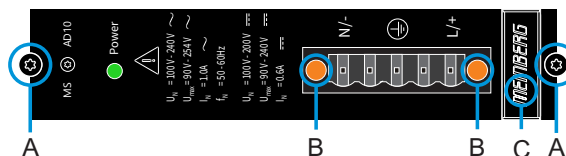

1. Interrupt the power supply of the power supply unit by pulling off the protective plug of the power cable.
2. Remove the 5-pin DFK-jack from the power supply after dissolving the two clamping screws (B) with the slot screwdriver.
3. Then loosen the two Torx screws (A) of the power supply that needs to be replaced with the Torx screwdriver (TR8).
4. The dissolved power supply can be removed with the handle (C) now.
5. Put the new power supply in the free slot and secure it with the two previously dissolved Torx fastening screws (A).
6. Connect the 5-pin DFK jack of the power cable to the power supply and put the two slit screws (B) back on.
7. The protective contact plug of the power cable can be reconnected to the power supply.
8. The LED of the new power supply should now light up. Furthermore, the status **Power Supply "green"** should be displayed in the Status System menu of the Meinberg Device Manager.

The status LED of the new power supply should now light up. The "OK" status must be displayed in the system's web interface.

Checking Power Status

The status of the power supplies can be observed in the program *Meinberg Device Manager* under "Status → System Status".

AD10 - AC/DC Power Supply

Connector Type:	5-pol. DFK
Pin Assignment:	1: N/- 2: not connected 3: PE (Protective Earth) 4: not connected 5: L/+

Input Parameter

Nominal Voltage Range:	U_N	=	100-240 V ~ 100-200 V ≐
------------------------	-------	---	----------------------------

Maximum Voltage Range:	U_{max}	=	90-254 V ~ 90-240 V ≐
------------------------	-----------	---	--------------------------

Nominal Current:	I_N	=	1.0 A ~ 0.6 A ≐
------------------	-------	---	--------------------

Nominal Frequency Range:	f_N	=	50-60Hz
--------------------------	-------	---	---------

Maximum Frequency Range:	f_{max}	=	47-63Hz
--------------------------	-----------	---	---------

Output Parameter

Maximum Power:	P_{max}	=	50 W
----------------	-----------	---	------

Max. Heat Emission:	E_{therm}	=	180.00 kJ/h (170.61 BTU/h)
---------------------	-------------	---	----------------------------

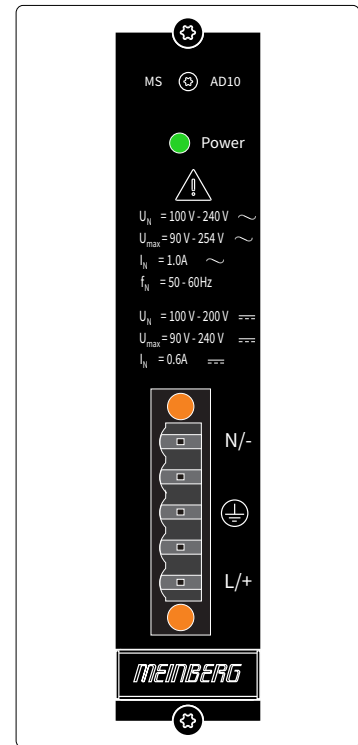

WARNING!

This equipment is operated at a hazardous voltage.



Danger to life due to electrical shock!

- Only qualified personnel (electricians) may connect the device.
- Never work with open terminals and plugs while the power is on.
- All connectors must be protected against touching live parts with a suitable plug housing!
- Note: Always ensure safe wiring!
- Important: The device must be connected to a proper grounding (PE).

DC20 - DC Power Supply

Connector Type: 5pin DFK

Pin Assignment:

- 1: not connected
- 2: V_{IN-}
- 3: PE (Protective Earth)
- 4: V_{IN+}
- 5: not connected

Input Parameter

Nominal Voltage Range: $U_N = 24-48\text{ V} \text{ ---}$

Maximum Voltage Range: $U_{max} = 20-60\text{ V} \text{ ---}$

Nominal Current: $I_N = 2.10\text{ A} \text{ ---}$

Output Parameter

Maximum Power: $P_{max} = 50\text{ W}$

Max. Heat Emission: $E_{therm} = 180.00\text{ kJ/h (170.61 BTU/h)}$

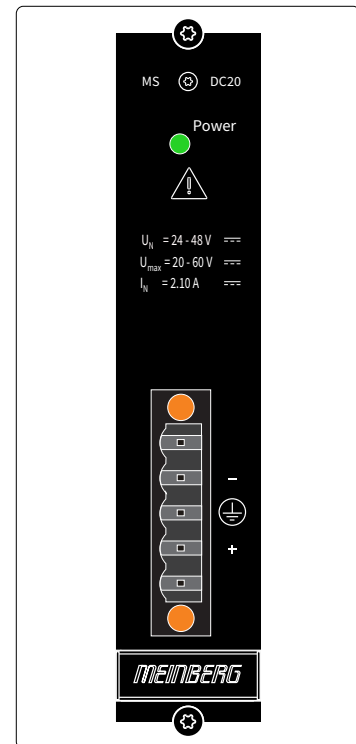

5.2 GPS Antenna

Cable:	shielded coax
Cablelength:	max. 300m to RG58, max. 700m to RG213
Connector:	BNC female or N-type female
Input GPS:	Antenna circuit 1000 V DC insulated

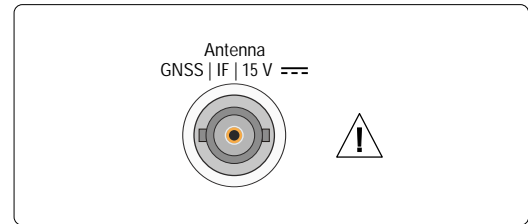

Local Oscillator to Converter Frequency: 10 MHz ¹

First IF Frequency: 35.42 MHz ¹

1) these frequencys are transfered via the antenna cable.

Power Supply: 15 V DC, 100mA (from receiver via the antenna cable)



WARNING!

Working on the antenna system during thunderstorms



Danger to life due to electrical shock!

- Do not carry out any work on the antenna system or the antenna cable if there is a risk of a lightning strike.
- Do not carry out any work on the antenna system if the safety distance to free lines and sequential circuits is exceeded.

5.3 Programmable pulse output

Signal output	Programmable pulses
Signal level:	TTL, 2.5 V into 50 Ohm
Connector:	BNC, female
Cable:	shielded coax line
Pulse outputs:	Pulse Per Second Cyclic Pulse Single Shot Timer Idle All Sync Time Sync Position OK DCF77 Marks Pulse Per Hour Pulse Per Min DCLS Time Code Serial Time String Synthesizer Frequency PTTI 1PPS

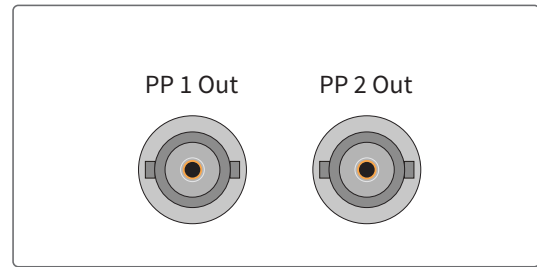

5.4 Pulse Per Second Input

Input signal	PPS (pulse per second)
Signal level:	TTL
Pulse length:	$\geq 5\mu\text{s}$, active high
Connection type:	BNC, female
Cable:	shielded coax line

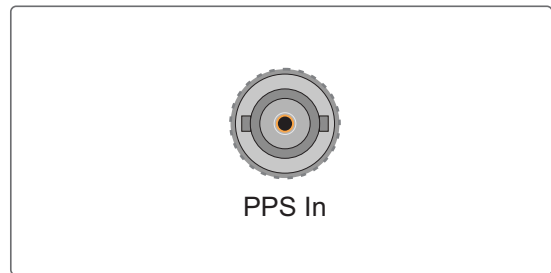

5.5 10 MHz Input

Input signal	10 MHz sinusoidal signal or TTL
Level:	$1.5 V_{pp} - 5 V_{pp}$
Connector:	BNC, female
Cable:	shielded coax line

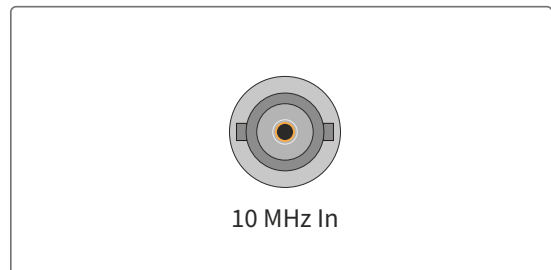

5.6 RS-232 COMx Timestring

Data transfer:	serial
Baudrate/framing:	19200 / 8N1 (default)
Time-string:	Meinberg Standard (default)
Assignment:	
Pin 2:	RxD (receive)
Pin 3:	TxD (transmit)
Pin 5:	GND (ground)
Connector:	9pin D-SUB male
Cable:	data cable (shielded) PC connector 1:1

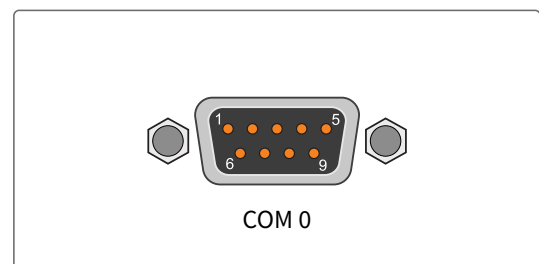

5.7 Status Indicators

CPU:

R (Receiver)

green: the reference clock (e.g. build-in GPS180) provides a valid time
 red: the reference clock does not provide a valid time

T (Time Service)

green: NTP is synchronized to the reference clock, e.g. GPS180
 red: NTP is not synchronized or switched to the "local clock"

N (Network)

green: all monitored network interfaces are connected ("Link up")
 red: at least one of the monitored network interfaces is faulty

A (Alarm)

off: no error
 red: general error

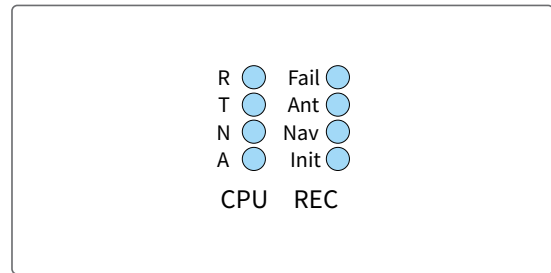

REC:

Fail

red: no synchronization

Ant

red: no synchronization resp. no antenna connected or short circuit on the antenna line
 green: antenna connected and clock is synchronized

Nav

green: positioning complete

Init

blue: initialisation phase

green: "warmed up" - oscillator is adjusted

5.8 USB Interface

Signal	Signal Type	Connector
USB Terminal	USB-to-serial console	Micro-USB Type B
USB Host	USB connector management CPU	USB Type A

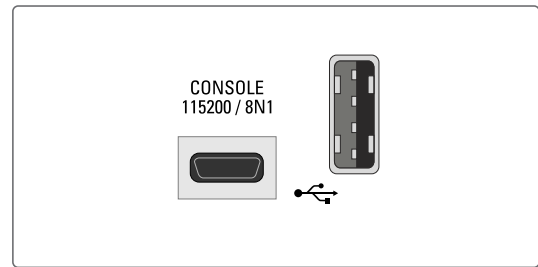

5.9 LAN Network Interfaces

Gigabit Ethernet (GbE), 100/1000 MBit - SFP

LAN 0, 1:	Management / NTP 10/100/1000Mbit RJ45 or 1000FX
LAN 2, 3:	Management / NTP 10/100/1000Mbit RJ45 or 1000FX PTP capable

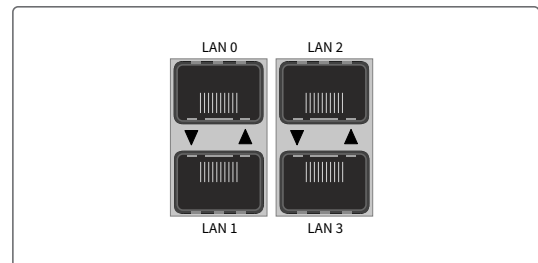

Recommended and tested Transceivers from other Vendors



MULTI MODE:	AVAGO AFBR-5710PZ FINISAR FTLF8524P3BNL
SINGLE MODE:	AVAGO AFCT-5710PZ FINISAR FTLF1318P3BTL
RJ-45:	AVAGO ABCU-5740RZ FINISAR FCLF8521P2BTL

5.10 DMC X2 Terminal Connector

Note: The connector on the device side and the connection socket of the X2 terminal are provided with coding pins to avoid confusion with the X1 connection terminal.

Pin 1	PP 5+	programmable pulse (optocoupler)
Pin 2	PP 5	programmable pulse (RS-422A)
Pin 3	PP 5	programmable pulse (RS-422B)
Pin 4	PP 6	programmable pulse (RS-422A)
Pin 5	PP 6	programmable pulse (RS-422B)
Pin 6	+ TC In	Time Code DCLS (TTL, isolated)
Pin 7	+ TCA* Out	Time Code DCLS (TTL, isolated)
Pin 8	- TCA Out	Time Code DCLS (TTL, isolated) <i>TTL active high 250mA, short circuit proof</i>
* TCA = Time Code Amplified, DCLS output with large output current.		
Pin 9	PP 5-	program. pulse (optocoupler)
Pin 10	GND	ground
Pin 11	GND	ground
Pin 12	GND	ground
Pin 13	GND	ground
Pin 14	- TC In	Time Code DCLS (TTL, isolated)
Pin 15		not used
Pin 16		not used

Status-LEDs:
PP 5 ... PP 8 Status of Pulses Out

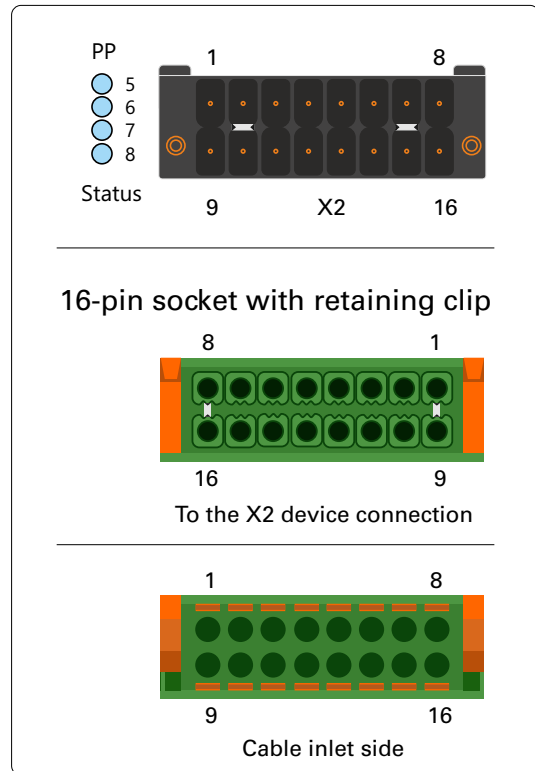

Scheme Terminal assignment

Programmable output PP 5
DC-insulated by optocouplers

U_{CEmax} = 55 V
 I_{Cmax} = 50 mA
 P_{tot} = 150 mW

Response time

Turn on Time: typ. $5\mu s$, max. $9\mu s$
Turn off Time: typ. $10\mu s$, max. $70\mu s$

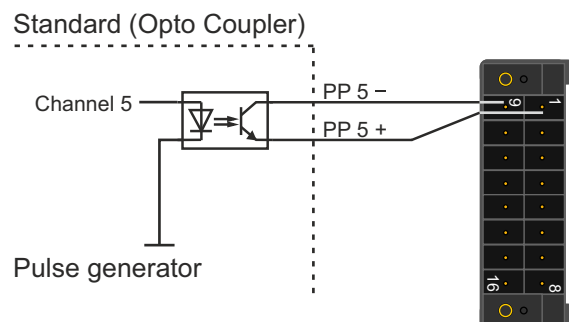

5.11 Fiber Optic - Programmable pulse Output

Output signal: Programmable pulses, fiber optic

Wave length: 850nm (multi mode)

Connection type: ST-connector

GI 50/125 μ m or
62,5 μ m gradient fibre

Pulse outputs: Pulse Per Second
Cyclic Pulse
Single Shot
Timer
Idle
All Sync
Time Sync
Position OK
DCF77 Marks
Pulse Per Hour
Pulse Per Min
DCLS Time Code
Serial Time String
Synthesizer Frequency
PTTI 1PPS

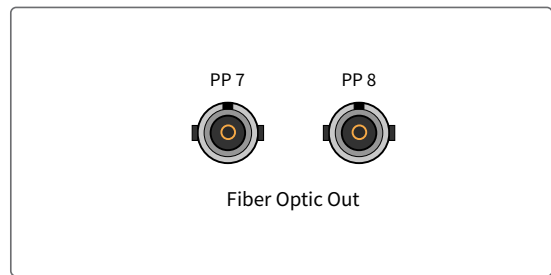

ATTENTION!

The optical interface contains a light-emitting diode (LED).

Unused connectors of optical interfaces should always be provided with a protective cap.

5.12 DMC X1 Terminal Connector

Pin 1	not used	
Pin 2		not used
Pin 3	PP 1-	programmable pulse
Pin 4	PP 2-	programmable pulse
Pin 5	PP 3-	programmable pulse
Pin 6	PP 4-	programmable pulse
Pin 7	REL-NO	Error/Relay (normally open)
Pin 8	REL-CO	Error/Relay (common)
Pin 9	not used	
Pin 10		not used
Pin 11	PP 1+	programmable pulse
Pin 12	PP 2+	programmable pulse
Pin 13	PP 3+	programmable pulse
Pin 14	PP 4+	programmable pulse
Pin 15	not used	
Pin 16	REL-NC	Error-Relay (normally closed)
Status-LEDs:		
PP 1 ... PP 4		Status of the programmable Pulses Out

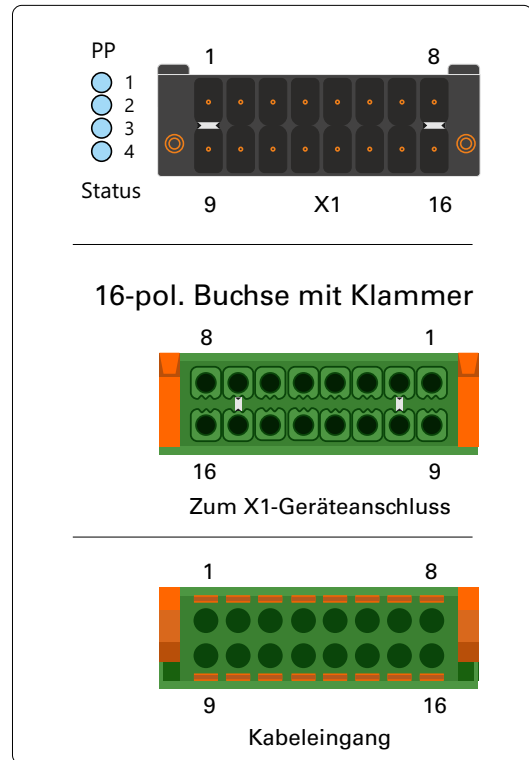

Scheme Terminal assignment Programmable Pulses

Four programmable outputs (PP 1 - PP 4)
DC-insulated by optocouplers

$$\begin{aligned} U_{CEmax} &= 55 \text{ V} \\ I_{Cmax} &= 50 \text{ mA} \\ P_{tot} &= 150 \text{ mW} \end{aligned}$$

Response time

Turn on Time: typ. $5\mu\text{s}$, max. $9\mu\text{s}$
Turn off Time: typ. $10\mu\text{s}$, max. $70\mu\text{s}$

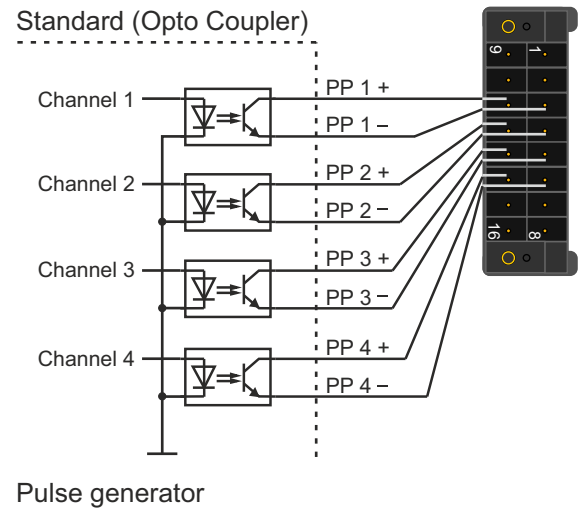

Error Relay

The X1 connector has a potential-free contact which is controlled directly by the used reference clock (GPS, GNS, GNS-UC). Normally, when the reference clock has synchronized, the the relay contact "NO" switch to active. If the reception is disturbed or the device is switched off, the relay contact "NC" is active.

Technical Specification

Switching Voltage max:	60 V DC
Switching Current max:	$I_{max} : 400\text{mA}$
Switching Load max:	24 W
Response Time:	ca.2ms

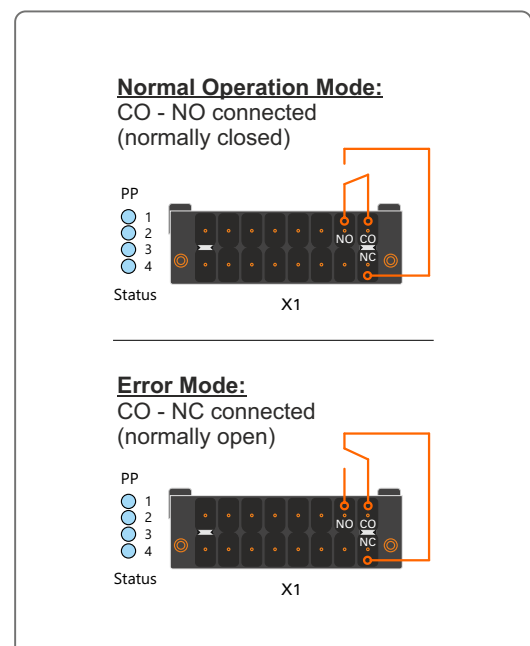

6 GNSS Satellite Navigation

The satellite receiver clock GPS180 has been designed to provide extremely precise time to its user. The clock has been developed for applications where conventional radio controlled clocks can't meet the growing requirements in precision. High precision available 24 hours a day around the whole world is the main feature of the new system which receives its information from the satellites of the russian GLONASS (GLObal NAVigation Satellite System) and the american GPS (Global Positioning System).

GPS and GLONASS are satellite-based radio-positioning, navigation, and time-transfer systems. They are based on accurately measuring the propagation time of signals transmitted from satellites to the user's receiver. A fully operational constellation of more than 24 satellites together with several active spares in six (GPS) respectively three (GLONASS) orbital planes in 20183 km (GPS) respectively 19100 km (GLONASS) over ground provides a minimum of four satellites to be in view 24 hours a day at every point of the globe. Four satellites need to be received simultaneously if both receiver position (x, y, z) and receiver clock offset from GPS/GLONASS system time must be computed. All the satellites are monitored by control stations which determine the exact orbit parameters as well as the clock offset of the satellites' on-board atomic clocks. These parameters are uploaded to the satellites and become part of a navigation message which is retransmitted by the satellites in order to pass that information to the user's receiver.

The high precision orbit parameters of a satellite are called ephemeris parameters whereas a reduced precision subset of the ephemeris parameters is called a satellite's almanac. While ephemeris parameters must be evaluated to compute the receiver's position and clock offset, almanac parameters are used to check which satellites are in view from a given receiver position at a given time. Each satellite transmits its own set of ephemeris parameters and almanac parameters of all existing satellites.

GPS was installed by the United States Department of Defense and provides two levels of accuracy: The Standard Positioning Service (SPS) and the Precise Positioning Service (PPS). While PPS is encrypted and only available for authorized (military) users, SPS has been made available to the general public.

GLONASS was developed to provide real-time position and velocity determination, initially for use by the Soviet military in navigating and ballistic missile targeting. Also GLONASS satellites transmit two types of signals: a Standard Precision (SP) signal and an obfuscated High Precision (HP) signal.

The BeiDou Navigation Satellite System (BDS) is a Chinese satellite navigation system. The second generation of the system, officially called the BeiDou Navigation Satellite System (BDS) and also known as COMPASS or BeiDou-2, will be a global satellite navigation system consisting of 35 satellites, and is under construction as of January 2015. It became operational in China in December 2011, with 10 satellites in use, and began offering services to customers in the Asia-Pacific region in December 2012. It is planned to begin serving global customers upon its completion in 2020.

Galileo is the global navigation satellite system (GNSS) that is currently being created by the European Union (EU) through the European Space Agency (ESA) and the European GNSS Agency (GSA). The use of basic Galileo services will be free and open to everyone.

The complete 30-satellite Galileo system (24 operational and 6 active spares) is expected by 2020. At an altitude of 23,222 km above the Earth's surface, the satellites require about 14 hours for one orbit.

6.1 Time Zone and Daylight Saving

GPS system time differs from the universal time scale (UTC) by the number of leap seconds which have been inserted into the UTC time scale since GPS was initiated in 1980. The current number of leap seconds is part of the navigation message supplied by the satellites, so the internal real time of the GPS180 is based on UTC time scale. Conversion to local time and annual daylight saving time can be done by the receiver's microprocessor if the corresponding parameters are set up by the user.

7 Mounting the GPS Antenna

The GPS satellites are not stationary, but circle round the globe with a period of about 12 hours. They can only be received if no building is in the line-of-sight from the antenna to the satellite, so the antenna/downconverter unit must be installed in a location that has as clear a view of the sky as possible. The best reception is achieved when the antenna has a free view of 8° angular elevation above the horizon. If this is not possible, the antenna should be installed with the clearest free view to the equator, because the satellite orbits are located between latitudes 55° North and 55° South. If this is not possible, you may experience difficulty receiving the four satellites necessary to complete the receiver's position solution.

The antenna/converter unit can be mounted on a wall, or on a pole up to 60 mm in diameter. A 50 cm plastic tube, two wall-mount brackets, and clamps for pole mounting are included. A standard RG58 coaxial cable should be used to connect the antenna/downconverter unit to the receiver. The maximum length of cable between antenna and receiver depends on the attenuation factor of the coaxial cable.

Up to four GPS180 receivers can be run with one antenna/downconverter unit by using an optional antenna splitter. The total length of an antenna line from antenna to receiver must not be longer than the max. length shown in the table below. The position of the splitter in the antenna line does not matter.

The optional delivered MBG S-PRO protection kit can also be used for outdoor installation (degree of protection: IP55). However, we recommend an indoor installation, as close as possible to the wall where the antenna cable is entering, to minimize the risk of overvoltage damage, for example by lightning.



WARNING!

Antenna mounting without effective anti-fall protection

Danger to life due to fall!

- Pay attention to effective working safety when installing antennas!
- Never work without an effective anti-fall equipment!



WARNING!

Working on the antenna system during thunderstorms

Danger to life due to electrical shock!

- Do not carry out any work on the antenna system or the antenna cable if there is a risk of a lightning strike.
- Do not carry out any work on the antenna system if the safety distance to free lines and sequential circuits is exceeded.



7.1 Antenna Cable:

Cable type	Cable (mm/in) \varnothing	Attenuation at 100 MHz (db)/100m/328ft	max. Cable length (m/ft)	used for receiver type
RG58/CU	5/0.2	17	300/984	GPS/GNS-UC/PZF
RG213	10,3/0.41	7	700/2297	GPS/GNS-UC
H155	5,4/0,21	9,1	70/230	GNM/GNS
H2010 Ultraflex	7,3/0,29	5,8	150/492	GNM/GNS

Further values can be found in the data sheet of the cable used.

7.2 Antenna Assembly with Surge Voltage Protection

Optional a surge voltage protector for coaxial lines is available. The shield has to be connected to earth as short as possible by using the included mounting bracket. Normally you connect the antenna converter directly with the antenna cable to the system.

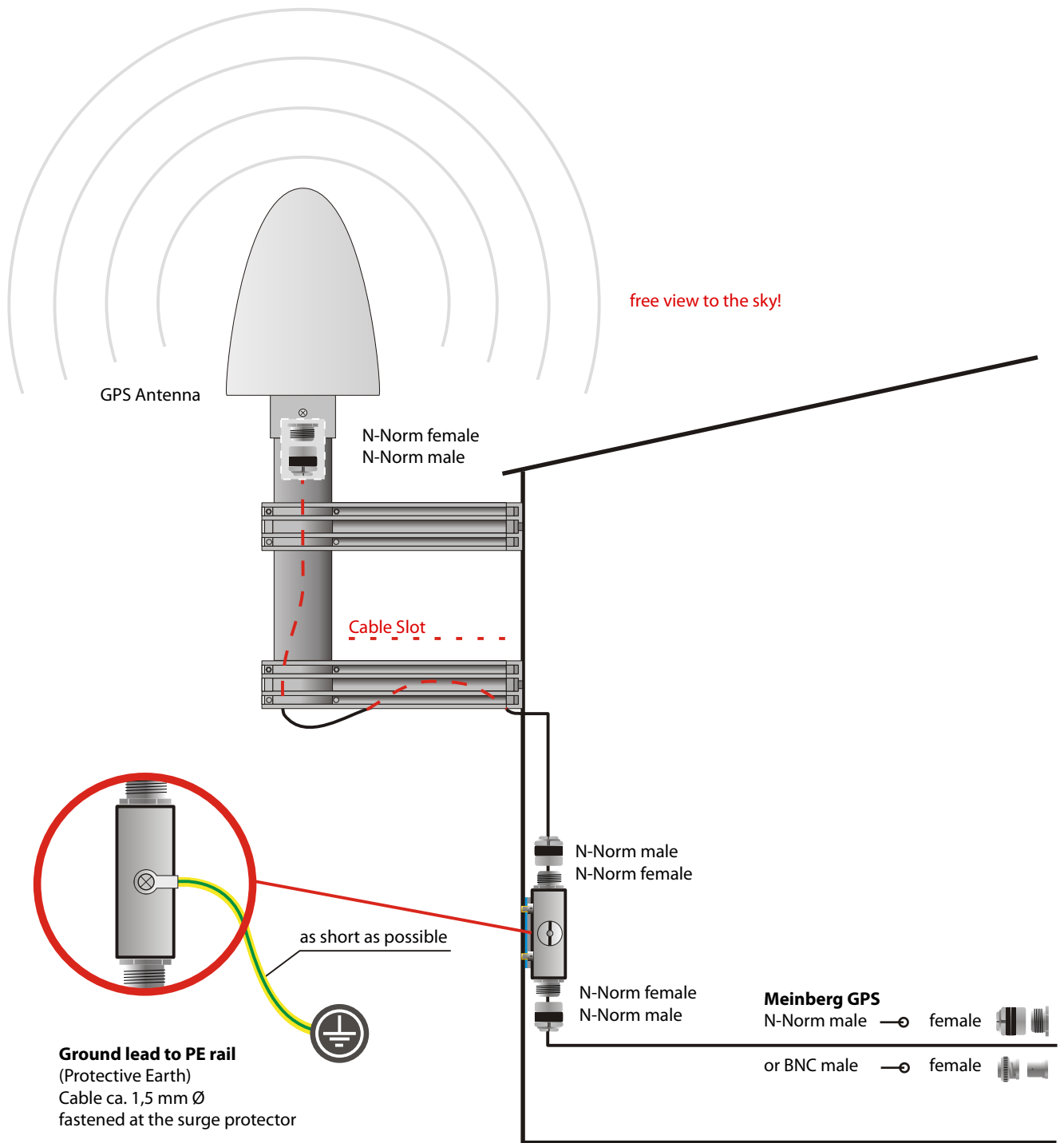

8 Starting of Operation

Meinberg Device Manager

The Meinberg Device Manager software is a graphical desktop application that allows to configure Meinberg modules and assembly groups over an encrypted network connection or a local USB or serial connection. A great advantage of the Meinberg Device Manager is that various modules/assembly groups can be configured and monitored simultaneously. The Meinberg Device Manager for Windows can be used under Windows 7 and all newer versions. Supported Linux distributions include Ubuntu, Mint Linux, Debian, SUSE Linux, CentOS, and others.

The software is delivered on the USB stick included in the scope of delivery and does not need to be installed or copied on the PC. The Meinberg Device Manager can be started directly from the USB data carrier. The computer must be connected to the network in which the microSync system is connected.

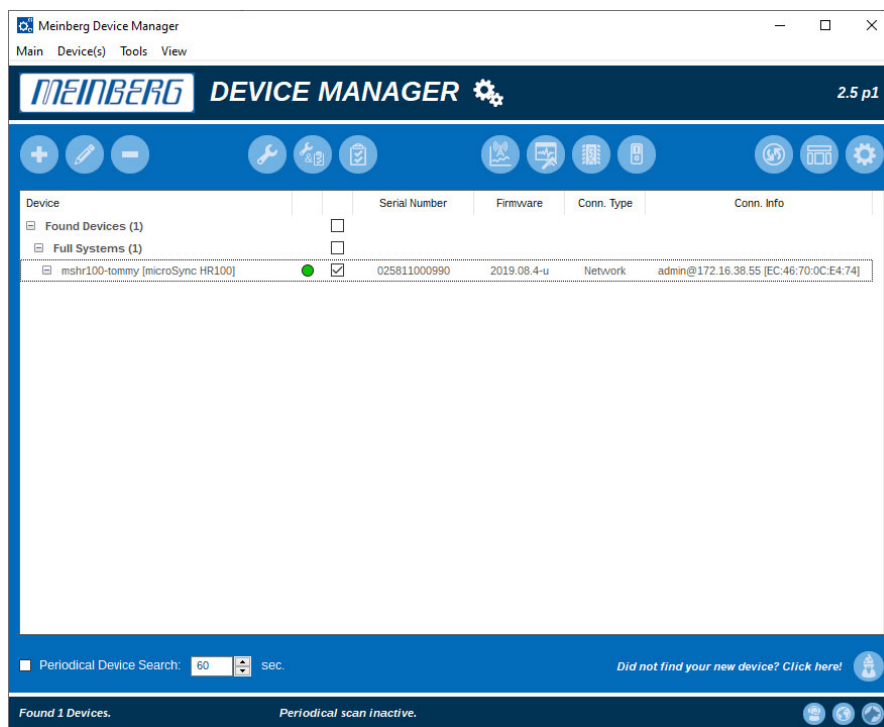

The software is downloadable free of charge from our homepage:
<https://www.meinbergglobal.com/english/sw/mbg-devman.htm>

Please Note:

You can download a complete and detailed manual about the Meinberg monitoring software on our homepage:
<https://www.meinbergglobal.com/download/docs/manuals/english/meinberg-device-manager.pdf>

8.1 Establishing a Network Connection

1. click on "Add Device".
2. select the connection type **Network**.
3. Enter the IPv4 address of the system to be connected to.

Parameter

- Authentication:** the Username & Password option is only supported for modules with MeinbergOS.
- Username (Optional):** enter the user name with which the Meinberg Device Manager should authenticate itself to your Meinberg system.
- Password:** enter a password with which Meinberg Device Manager should authenticate itself to your Meinberg system.
- Silent Login:** you have the possibility that the Meinberg Device Manager will not ask for your username and password every time you log in.



Changing your Network Password

To change the password for the currently logged in user, click this icon.

Host Key Verification

To enable a secure connection to the system via SSH, you must add the key used to your known hosts. This ensures that this device can be permanently identified as a trusted communication partner.

To confirm, click on Yes.

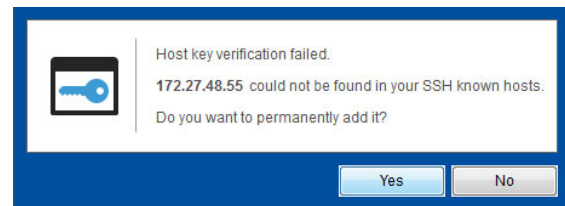

8.1.1 Connecting with the Network Configuration Wizard

The "Network Configuration Wizard" allows you to connect to your microSync system.

Start the Network Configuration Wizard

You will find the wizard in the Section 4 of the start screen on the bottom right. This opens by clicking on the button. The configuration is explained step by step.

MAC Address

Enter the 12-digit MAC address located on your Meinberg module. Then confirm the entry with "Next" to continue.

Hostname

Enter any host name for your system or leave the field blank. Then confirm the entry with Next to continue.

Static IP or DHCP

In the next step you can determine whether you want to enter the IP address manually or whether a DHCP server should assign the IP address automatically.

Static IP

Enter the IP address, netmask, gateway and DNS server into the fields. Then confirm with Next to continue.

DHCP Client

The DHCP client is activated. Click Next to continue.

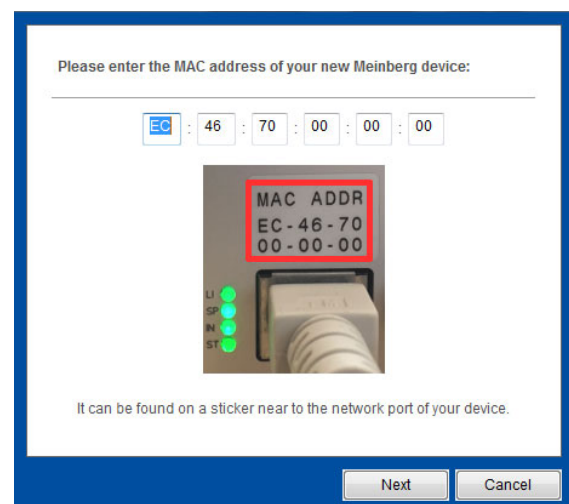

When assigning the IP address via the wizard, the following must be observed:

- PC and the corresponding system must be physically connected in the same network.
- IP configuration via a gateway/router is not possible.
- A forwarding of broadcast packets in the network is usually blocked or not allowed.

9 Technical Appendix

9.1 Technical Specifications GPS Receiver

Receiver:	12 - channel C/A code receiver with external antenna/converter unit	
Antenna:	antenna/converter unit with remote power supply refer to chapter "Technical specifications of antenna"	
Power Supply for Antenna:	15 V DC, continuous short circuit protection, automatic recovery isolation voltage 1000 VDC, provided via antenna cable	
Antenna Input:	antenna circuit dc-insulated; dielectric strength: 1000V length of cable: refer to chapter "Mounting the Antenna"	
Time to Synchronization:	one minute with known receiver position and valid almanac 12 minutes if invalid battery buffered memory	
Pulse Outputs:	eight programmable outputs (PP 1 - PP 8) DC-insulated by optocouplers $U_{CEmax} = 55 \text{ V}$, $I_{Cmax} = 50 \text{ mA}$, $P_{tot} = 150 \text{ mW}$, $V_{iso} = 5000 \text{ V}$	
	pulse delay:	t_{on} e.g. $20 \mu\text{sec}$ ($I_C = 10\text{mA}$) t_{off} e.g. $3 \mu\text{sec}$ ($I_C = 10\text{mA}$)
	change of second (P_SEC, TTL level) change of minute (P_MIN, TTL level)	
Accuracy of Pulses:	after synchronization and 20 minutes of operation OCXO SQ/MQ/HQ/DHQ: better than $\pm 50 \text{ nsec}$ better than $\pm 2 \mu\text{sec}$ during the first 20 minutes of operation	
Frequency Outputs:	10 MHz, TTL level into 50 Ohm 1 MHz, TTL level 100 kHz, TTL level	
Frequency Synthesizer:	1/8 Hz up to 10 MHz	
Accuracy of Synthesizer:	base accuracy depends on system accuracy	
	1/8 Hz to 10 kHz	Phase synchron with pulse output P_SEC
	10 kHz to 10 MHz	frequency deviation $< 0.0047 \text{ Hz}$
Synthesizer Outputs:	F_SYNTH:	TTL level
	F_SYNTH_OD:	open drain drain voltage: $< 100 \text{ V}$ sink current to GND: $< 100 \text{ mA}$ dissipation power at $25 \text{ }^\circ\text{C}$: $< 360 \text{ mW}$
	F_SYNTH_SIN:	sine-wave

output voltage: 1.5 V eff.
output impedance: 200 Ohm

Serial Ports: 2 asynchronous serial ports RS-232 (optional max. 4 serial ports)
Baud Rate: 300, 600, 1200, 2400, 4800, 9600, 19200 Baud
Framing: 7E1, 7E2, 7N2, 7O1, 7O2, 8E1, 8N1, 8N2, 8O1

default setting:
COM0: 19200, 8N1
Meinberg Standard time string, per second

Time Code Outputs: Unbalanced modulated sine wave signal:
3 V_{pp} (MARK), 1 V_{pp} (SPACE) into 50 ohm

DCLS-signal: TTL into 50 ohm, active-high or -low

9.2 Configuration Options

Receiver Options

RECEIVER TYPE	SIGNAL TYPE	VALUE	CONNECTOR
Meinberg GPS IF, 12-channel	IF (Meinberg Antenna))	15 V	DC BNC
Meinberg GNS-UC GPS/Galileo IF	IF (Meinberg Antenna))	15 V DC	BNC
GNSS (GPS, GLONASS, Galileo, BeiDou), 72-channel	L1/E1/B1 band	5 V DC	SMA

Oscillator Options

TYP	HOLDOVER PERFORMANCE (1 DAY)	HOLDOVER PERFORMANCE (1 YEAR)
OCXO SQ	+/- 220 μ sec	+/- 4.7 sec
OCXO MQ	+/- 65 μ sec	+/- 1.6 sec
OCXO HQ	+/- 22 μ sec	+/- 788 msec
OCXO DHQ	+/- 4.5 μ sec	+/- 158 msec

9.3 Protocols and Profiles

NETWORK PROTOCOLS	IEEE 1588 PROFILES
IPv4, IPv6	IEEE 1588v2 Default Profile
NTPv3, NTPv4	IEEE C.37.238-2011 Power Profile
PTPv1, PTPv2	IEEE C.37.238-2017 Power Profile
IEC 62439-3 (PRP)	IEC/IEEE 61850-9-3 Power Utility Profile
DHCP, DHCPv6	Enterprise-Profile
DSCP	ITU-T G.8265.1, ITU-T G.8275.1, ITU-T G.8275.2 Telecom Profile
IEEE 802.1q VLAN filtering/tagging	SMPTE ST 2059-2 Broadcast Profile
IEEE 802.1p QOS	IEEE 802.1AS TSN/AVB Profile
SNMPv1/v2/v3	AES67 Media Profile
Remote Syslog Support (UDP)	DOCSIS 3.1

9.4 Compliances

Compliance	
CB Scheme	
CE	
FCC	
UL	
CSA	
WEEE	Waste of Electrical and Electronic Equipment
RoHS	Restriction of Hazardous Substances
REACH	Registration, Evaluation, Authorization and Restriction of Chemicals

10 RoHS and WEEE

Compliance with EU Directive 2011/65/EU (RoHS)

We hereby declare that this product is conform to the European Directive 2011/65/EU and its delegated directive 2015/863/EU "Restrictions of Hazardous Substances in Electrical and Electronic Equipment". We ensure that electrical and electronic products sold in the EU do not contain lead, cadmium, mercury, hexavalent chromium, polybrominated biphenyls (PBBs), and polybrominated diphenyl ethers (PBDEs), Bis (2-ethylhexyl)phthalat (DEHP), Benzylbutylphthalat (BBP), Dibutylphthalat (DBP), Diisobutylphthalat (DIBP), above the legal threshold.



WEEE status of the product

This product is handled as a B2B (Business to Business) category product. In order to secure a WEEE compliant waste disposal it has to be returned to the manufacturer. Any transportation expenses for returning this product (at its end of life) have to be incurred by the end user, whereas Meinberg will bear the costs for the waste disposal itself.



11 Declaration of Conformity

Declaration of Conformity

Doc ID: microSync RX311/AD10DC20-2020-06-17

Hersteller Meinberg Funkuhren GmbH & Co. KG
Manufacturer Lange Wand 9, D-31812 Bad Pyrmont

erklärt in alleiniger Verantwortung, dass das Produkt,
declares under its sole responsibility, that the product

Produktbezeichnung microSync RX311/AD10DC20
Product Designation

auf das sich diese Erklärung bezieht, mit den folgenden Normen und Richtlinien übereinstimmt:
to which this declaration relates is in conformity with the following standards and provisions of the directives:

RED – Richtlinie ETSI EN 303 413 V1.1.1 (2017-06)
RED – Directive

2014/53/EU

EMV – Richtlinie Draft ETSI EN 301 489-1 V2.2.0 (2011-09)
EMC – Directive Draft ETSI EN 301 489-19 V2.1.0 (2011-09)
2014/30/EU DIN EN 61000-6-2:2005
 DIN EN 61000-6-3:2007 + A1:2011
 DIN EN 55032:2015
 DIN EN 55024:2010

Niederspannungsrichtlinie DIN EN 62368-1:2014 + AC:2015
Low-voltage Directive

2014/35/EU

RoHS – Richtlinie DIN EN 50581:2012
RoHS – Directive

2011/65/EU + 2015/863/EU

Bad Pyrmont, 2020-06-17

Stephan Meinberg
Production Manager