



The Synchronization Experts.



MANUAL

IMS-M2000S

Modular Sync. System and
NTP Server

August 9, 2022

Meinberg Funkuhren GmbH & Co. KG

Rear view (Rückansicht) IMS-M2000S

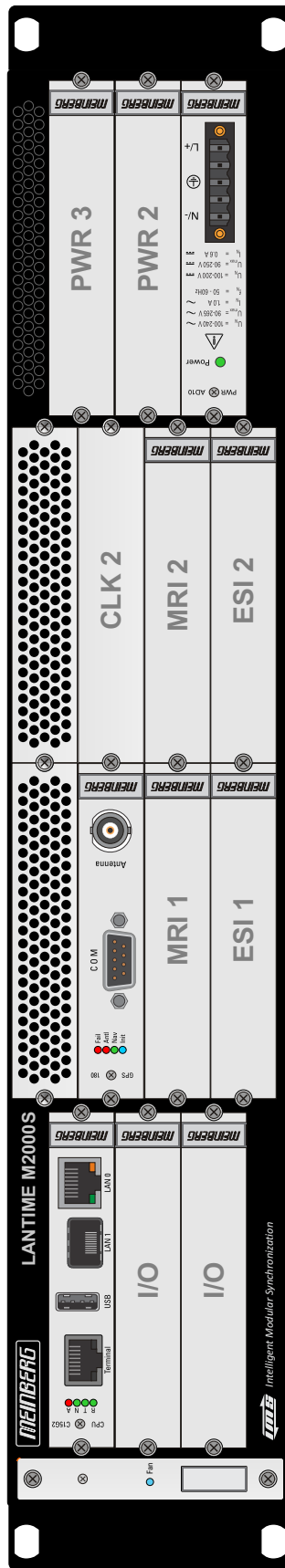

Table of Contents

| | | |
|-----------|---|-----------|
| 1 | Imprint | 1 |
| 2 | The System M2000S | 2 |
| 2.1 | IMS - Systems | 2 |
| 2.2 | Target Audience | 2 |
| 2.3 | Return of Equipment | 2 |
| 3 | M2000S System Description | 3 |
| 3.1 | Device Design, Functions and Area of Application | 3 |
| 3.2 | IMS System Variants | 4 |
| 3.3 | Hardware Specifications | 5 |
| 3.3.1 | Chassis Variants | 5 |
| 3.3.2 | Environmental Requirements | 6 |
| 4 | Important Safety Information | 7 |
| 4.1 | Important Safety Information and Safety Precautions | 7 |
| 4.2 | Used Symbols | 8 |
| 4.3 | Product Documentation | 9 |
| 4.4 | Safety during Installation | 10 |
| 4.5 | Connection of Protective Earth Conductor/Grounding | 13 |
| 4.6 | Safety During Operation | 14 |
| 4.7 | Safety During Maintenance | 15 |
| 4.8 | Handling of Batteries | 16 |
| 4.9 | Safety Information for SFP Modules | 17 |
| 4.10 | Cleaning and Care | 18 |
| 4.11 | Prevention of ESD Damage | 18 |
| 4.12 | Return of Electrical and Electronic Equipment | 19 |
| 5 | Before you start | 20 |
| 5.1 | Text and Syntax Conventions | 20 |
| 5.2 | Abbreviation List | 21 |
| 5.3 | Required Tools | 23 |
| 5.4 | Preparing Installation | 24 |
| 5.5 | Unboxing the Device | 25 |
| 5.6 | Disposal of Packaging Materials | 27 |
| 6 | System Installation | 28 |
| 6.1 | Antenna Connection | 29 |
| 6.1.1 | Mounting the Antenna | 30 |
| 6.2 | Connecting the System | 46 |
| 6.3 | Initial Network Configuration | 47 |
| 7 | System Operation - Configuration and Monitoring | 49 |
| 8 | Maintenance, Servicing and Repairing | 50 |
| 8.1 | Firmware Updates | 50 |
| 9 | Troubleshooting and Alarming | 51 |
| 9.1 | System Error Messages | 52 |
| 10 | Support Information | 53 |
| 10.1 | Basic Customer Support | 54 |
| 10.2 | Support Ticket System | 54 |

| | | |
|-----------|---|------------|
| 10.3 | How to download a Diagnostic File | 55 |
| 10.3.1 | Download via Web GUI | 55 |
| 10.3.2 | Download via USB Stick | 55 |
| 10.4 | Self-Help Online Tools | 56 |
| 10.5 | NTP and IEEE 1588-PTP online tutorials | 56 |
| 10.6 | The Meinberg Academy introduction and offerings | 57 |
| 10.7 | Meinberg Newsletter | 57 |
| 11 | Technical Appendix | 58 |
| 11.1 | Available Modules and Connectors | 58 |
| 11.2 | Terminal | 60 |
| 11.3 | USB Port | 60 |
| 11.4 | Replacement or Installation of a Hot-pluggable IMS Module | 61 |
| 11.4.1 | Important Information Regarding Hot-Pluggable IMS Modules | 62 |
| 11.5 | IMS Module Options | 63 |
| 11.5.1 | IMS M2000S Slot Assignment | 63 |
| 11.5.2 | Power Supply 100-240 V AC / 100-200 V DC | 64 |
| 11.5.3 | Power Supply 20-60 V DC | 65 |
| 11.5.4 | Power Supply 10-36 V DC | 66 |
| 11.5.5 | IMS Receiver Modules | 67 |
| 11.5.6 | RSC Switch Card | 79 |
| 11.5.7 | LAN-CPU | 81 |
| 11.5.8 | MRI - Standard Reference Input Signals | 83 |
| 11.5.9 | ESI - Telecom Synchronisation References | 87 |
| 11.5.10 | VSI - Video Synchronization Input Card | 91 |
| 11.5.11 | IMS Network Modules | 97 |
| 11.5.12 | CPE and BPE Output Modules (Frontend - Backend, Eurocard) | 108 |
| 11.5.13 | PIO180 - PPS or 10 MHz I/O Module | 128 |
| 11.5.14 | LIU - Line Interface Unit | 131 |
| 11.5.15 | LNO - Sine Wave Outputs with low Phase Noise | 139 |
| 11.5.16 | REL1000 - Error Relay Module | 141 |
| 11.5.17 | FDM - Frequency Deviation Monitoring | 146 |
| 11.5.18 | SCG-U: Studio Clock Generator | 148 |
| 11.5.19 | SCG-B: Studio Clock Generator Balanced | 150 |
| 11.5.20 | VSG - Video Sync Generator | 152 |
| 11.5.21 | VSG181H - Video Sync Generator with D-Sub Output | 157 |
| 11.5.22 | ACM - Active Cooling Module | 164 |
| 12 | RoHS and WEEE | 165 |
| 13 | Declaration of Conformity | 166 |

1 Imprint

Meinberg Funkuhren GmbH & Co. KG
Lange Wand 9, 31812 Bad Pyrmont, Germany

Phone: + 49 (0) 52 81 / 93 09 - 0
Fax: + 49 (0) 52 81 / 93 09 - 230

Website: <https://www.meinbergglobal.com>
Email: info@meinberg.de

Date: August 4, 2022

Manual
Version: 1.04

2 The System M2000S

2.1 IMS - Systems



The brand IMS describes a product family of Meinberg radio clocks for synchronization of time and frequency signals in networks and of directly connected systems such as signal distributors.

Meinberg's IMS Series (Intelligent Modular Synchronization) offers built-in redundancy for synchronization sources and power supplies in combination with highly modular slot based chassis, which support hot-swapping and field-expansion capabilities.

The design of our IMS enclosures allows to use up to four power supplies (both AC and DC variants can be mixed and matched), two time code receivers in combination with a signal switch module, a CPU board and up to ten I/O slots.

2.2 Target Audience

This manual is intended for professionals responsible for the installation, commissioning, maintenance, troubleshooting or operation of any of the equipment within the specified product range.

The structure and spelling of this manual assumes that the installation and commissioning technicians have knowledge of the use of electrical devices and network components.

2.3 Return of Equipment

All parts and components of your Meinberg system may only be repaired by Meinberg. In the event of a malfunction, the customer must contact our support service and never attempt to repair the device himself.

To request a device repair service, call Meinberg Technical Support to check shipping options and obtain the Return Material Authorization (RMA) number for shipping.

You can also request the RMA number from our website:
<https://www.meinbergglobal.com/english/support/rma.htm>.

The device must be packed in its original packaging or suitable packaging to protect it from shock and moisture. Send your device to the manufacturer's address, including sender identification and RMA number.

What must be included with the shipment?

Please return the device complete with accessories such as antenna or cable if possible. This may be important for troubleshooting.

3 M2000S System Description

3.1 Device Design, Functions and Area of Application

The IMS-LANTIME-System is a set of equipment composed of a reference module, a single-board computer module (LAN-CPU) with integrated network card, and a power supply unit, all installed in a modular chassis and ready to operate. The input/output signals of the IMS systems are provided on the connection side via I/O modules.

The implemented NTPD distributes the reference time from the reference module cyclic in the network. Information on the NTPD is monitored on the LC-Display (if available) or can be queried via the network.

The installation of an IMS LANTIME is very easy for the system/network administrator. The network address, the netmask and the default gateway have to be configured from the front panel of LANTIME. The network address or the equivalent name of LANTIME has to be shown to all NTP clients in the TCP/IP network.

As well as NTP the Linux system also supports a number of further network protocols: HTTP(S), FTP, SSH and Telnet. Because of this remote configuration or status requests can come from any WEB browser. This access via the network can be deactivated. Changes in the receiver status, errors or other important events are logged either on the local Linux system or on an external SYSLOG-Server. In addition messages can be sent to a data center via SNMP traps or automatically generated e-mails where they can be recorded. Furthermore all alarm messages can be displayed by the large display VP100/20/NET that is accessed via network connection. In order to avoid a service interruption several LANTIME NTP servers can be installed in the same network to obtain redundancy.

3.2 IMS System Variants

The IMS system variants differ primarily in their housing form.

19 inch rack mount chassis

The base chassis contains a power supply, a receiver and the LANTIME CPU. This provides further slots for additional input and output modules.

M1000(S): four slots for expansion cards
 three slots for expansion cards in redundant receiver configuration

M2000S: six slots for expansion cards

M3000(S): ten slots for expansion cards

M4000: ten slots for expansion cards

Redundant power supply and receiver solutions can be implemented for the following IMS series models:

M1000(S): up to two power supplies and two receivers

M2000S: up to three power supplies and two receivers

M3000(S): up to four power supplies and two receivers

M4000: up to four power supplies and two receivers

Railmount Chassis

The base chassis contains a power supply, a receiver and the LANTIME CPU.

M500: two slots for expansion cards
 one configurable expansion slot (CES) with two optional output signals

3.3 Hardware Specifications

3.3.1 Chassis Variants

The IMS systems are offered in several housing variants. The hardware configuration is modular and the number of input and output options depends on the respective housing variant.

| IMS system | Type | Dimension in mm* (W x H x D) | IO Slots | Power Supplies | Receivers |
|------------|---------------------------------|---------------------------------|----------|----------------|-----------|
| M500 | DIN railmount | 118 x 193 (227) x 160 | 2 | 1 | 1 |
| M1000 | 19 inch rackmount 1HE / 84TE | 483 x 44 x 290 (314) | 4 (3)** | 1 - 2 | 1 - 2 |
| M1000(S) | 19 inch rackmount 1HE / 84TE | 483 x 44 x 266 (300) | 4 (3)** | 1 - 2 | 1 - 2 |
| M2000S | 19 inch rackmount 2HE / 84TE | 483 x 76 x 248 (264) | 6 | 1 - 3 | 1 - 2 |
| M3000 | 19 inch rackmount 3HE / 84TE | 483 x 133 x 280 (307) | 10 | 1 - 4 | 1 - 2 |
| M3000(S) | 19 inch rackmount 3HE / 84TE | 483 x 133 x 234 (268) | 10 | 1 - 4 | 1 - 2 |
| M4000 | 19 inch rackmount 4HE / 84TE | 483 x 133 x 274 | 10 | 1 - 4 | 1 - 2 |

The IMS systems M500, M1000, M3000 and M4000 have a 4 x 20 character LC display and a control panel with 8 function keys for direct on-site configuration. The M1000S, M2000S and M3000S models are delivered without a display. These systems, like the M4000, are optimized for ETSI rack installations due to their small housing depth.

The available configurations can be optimally adapted for specific application areas and industries.

* The sizes in parentheses take into account the connections and module handles.

** With a redundant receiver configuration, only 3 IO slots are available in an M1000 system.

3.3.2 Environmental Requirements

Protection Rating: IP20

Ambient Temperature: 0 ... 50 °C

Storage Temperature: -20 ... 70 °C

Humidity: max. 85% (non-condensing) @ 30 °C

Please Note:

To prevent overheating damage during operation, some IMS systems are equipped with an active cooling module (ACM). The generated air flow is led through the system as shown in the figure on the right (see also chapter "ACM - Active Cooling Module" or "RCU - Rack Cooling Module").

Active cooling with ACM modules.

Active cooling modules are available for the M4000, M3000 and M1000(S) IMS systems. For the M4000 and M3000, the use of an ACM is optional. M1000 and M2000 systems are always equipped with an ACM.

Passive cooling.

Due to the small installation depth, it is not possible to integrate an ACM module in an M3000S system. For this reason, we have developed a 1U passive cooling enclosure that can be installed under the IMS system in the server rack. The RCU module (Rack Cooling Unit) provides an optimal airflow for the dissipation of the warm air.



4 Important Safety Information

4.1 Important Safety Information and Safety Precautions

The following safety information must be observed whenever the device is being installed or operated. Failure to observe this safety information and other special warnings or operating instructions in the product manuals constitutes improper usage and may violate safety standards and the manufacturer's requirements.



Depending on the configuration of your device or installed options, some information may not specifically apply to your device.



The device satisfies the requirements of the following EU regulations: EMC Directive, Low Voltage Directive, RoHS Directive and—where applicable—the Radio Equipment Directive.

If a procedure is marked with the following signal words, you may only proceed with it if you have understood and fulfilled all requirements. Hazard notices and other relevant information are classified and indicated as such in this manual according to the following system:



DANGER!

This signal word indicates a hazard with a high risk level . Such a notice refers to a procedure or other action that will very likely result in serious injury or even death if not observed or if improperly performed.



WARNING!

This signal indicates a hazard with a medium risk level . Such a notice refers to a procedure or other action that may result in serious injury or even death if not observed or if improperly performed.



CAUTION!

This signal word indicates a hazard with a low risk level . Such a notice refers to a procedure or other action that may result in minor injury if not observed or if improperly performed.















ATTENTION!

This signal word refers to a procedure or other action that may result in product damage or the loss of important data if not observed or if improperly performed.

4.2 Used Symbols

The following symbols and pictograms are used in this manual. Pictograms are used in particular to indicate potential hazards in all hazard categories.

| Symbol | Beschreibung / Description |
|---|---|
|  | IEC 60417-5031 Gleichstrom / <i>Direct current</i> |
|  | IEC 60417-5032 Wechselstrom / <i>Alternating current</i> |
|  | IEC 60417-5017 Erdungsanschluss / <i>Earth (ground) terminal</i> |
|  | IEC 60417-5019 Schutzleiteranschluss / <i>Protective earth (ground) terminal</i> |
|  | ISO 7000-0434A Vorsicht / <i>Caution</i> |
|  | IEC 60417-6042 Vorsicht, Risiko eines elektrischen Schlages / <i>Caution, risk of electric shock</i> |
|  | IEC 60417-5041 Vorsicht, heiße Oberfläche / <i>Caution, hot surface</i> |
|  | IEC 60417-6056 Vorsicht, Gefährlich sich bewegende Teile / <i>Caution, moving parts</i> |
|  | IEC 60417-6172 Trennen Sie alle Netzstecker / <i>Disconnect all power connectors</i> |
|  | IEC 60417-5134 Elektrostatisch gefährdete Bauteile / <i>Electrostatic Discharge Sensitive Devices</i> |
|  | IEC 60417-6222 Information generell / <i>General information</i> |
|  | 2012/19/EU Dieses Produkt fällt unter die B2B Kategorie. Zur Entsorgung muss es an den Hersteller übergeben werden. <i>This product is handled as a B2B-category product. To ensure that the product is disposed of in a WEEE-compliant fashion, it must be returned to the manufacturer.</i> |

4.3 Product Documentation

Detailed product documentation is provided on a USB flash drive delivered with the Meinberg system. The manuals can also be downloaded from the Meinberg website at <https://www.meinbergglobal.com>, where you can enter your system name into the search box at the top of the page to find the relevant manual. Alternatively, contact Meinberg Support for further assistance.

The "Docs & Support" menu on the Web Interface also provides user manuals for time server administrators.



This manual contains important safety instructions for the installation and operation of the device. Please read this manual thoroughly before using the device.

This device may only be used for the purpose described in this manual. In particular, the specified operating limits of the device must be heeded. The person setting up the device is responsible for safety matters in relation to any larger system in which the device is installed!

Failure to observe these instructions may have an adverse impact on device safety!

Please keep this manual in a safe place.

Target Readership

This manual is only intended to be used by qualified electricians, or by persons who have been appropriately instructed by a qualified electrician and who are familiar with applicable national standards and with safety rules & regulations. This device may only be installed, set up, and operated by qualified personnel.

4.4 Safety during Installation



WARNING!

Pre-Operation Procedures and Preparation for Use

This mountable device has been designed and examined in accordance with the requirements of the standard IEC 62368-1 "Audio/Video, Information and Communication Technology Equipment - Part 1: Safety Requirements".

When the mountable device is to be used as part of a larger unit (e.g., electrical enclosure), there will be additional requirements in the IEC 62368-1 standard that must be observed and complied with. General requirements regarding the safety of electrical equipment (such as IEC, VDE, DIN, ANSI) and applicable national standards must be observed in particular.

The device has been developed for use in the industrial sector or in home environments and may only be used in such environments. In environments at risk of high environmental conductivity ("high pollution degree" according to IEC 60664-1), additional measures such as installation of the device in an air-conditioned electrical cabinet may be necessary.

Transport, Unpacking, Installation

If the unit has been brought into the usage area from a cold environment, condensation may develop; in this case, wait until the unit has adjusted to the temperature and is completely dry before setting it up.

When unpacking & setting up, and before operating the equipment, be sure to read the information on installing the hardware and the specifications of the device. These include, for example, dimensions, electrical characteristics, or necessary environmental conditions.

Fire safety standards must be upheld with the device in its installed state.

The device must not be damaged in any way when mounting it. In particular, holes must not be drilled into the housing.

For safety reasons, the device with the highest mass should be installed at the lowest position in the rack. Further devices should be installed from the bottom, working your way up.

The device must be protected against mechanical & physical stresses such as vibration or shock.



Connecting Data Cables

Do not connect or disconnect data cables during a thunderstorm, as doing so presents a risk in the event of a lightning strike.

The device cables must be connected or disconnected in the order specified in the user documentation for the device. Cables should always be held by the connector body when connecting or disconnecting them. Never pull a connector out by pulling on the cable. Doing so may cause the plug to be detached from the cable or cause damage to the plug itself.

Cables must be installed so that they do not represent a health & safety hazard (e.g., tripping) and are not at risk of damage (e.g., kinks).

Connecting the Power Supply

This equipment is operated at a hazardous voltage. Failure to observe the safety instructions in this manual may result in serious injury, death or property damage.

Before the device is connected to the power supply, a grounding conductor must be connected to the earth terminal of the device.

The power supply should be connected with a short, low-inductance cable.

Before operation, check that all cables and lines work properly and are undamaged. Ensure in particular that the cables do not have kinks, that they are not wound too tightly around corners, and that no objects are placed on the cables.

Ensure that all connections are secure—make sure that the lock screws of the power supply plug are tightened when using a 3-pin MSTB or 5-pin MSTB connector (see diagram, LANTIME M300 power supply).

5-Pin MSTB Connector

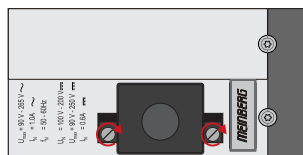

3-Pin MSTB Connector

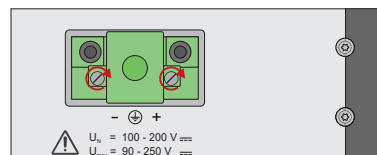

Faulty shielding or cabling and improperly connected plugs are a health & safety risk (risk of injury or death due to electrical shock) and may damage or even destroy your Meinberg device or other equipment.

Ensure that all necessary safety precautions have been taken. Connect all cables to the device only while the device is de-energized before turning on the power. Observe the safety instructions on the device itself (see safety symbols).

The metal chassis of the device is grounded. When installing the device in an electrical enclosure, it must be ensured that adequate clearance is provided, creepage distances to adjacent conductors are maintained, and that there is no risk of short circuits.

In the event of a malfunction or if servicing is required (e.g., damage to the chassis or power cable, ingress of fluids or foreign objects), the power supply may be cut off.

Please address any questions regarding your building's electrical, cable or antenna installations to the person or department responsible for that installation within your building.

| AC Power Supply | DC Power Supply |
|---|---|
| <ul style="list-style-type: none"> • The device is a Protection Class 1 device and may only be connected to a grounded outlet (TN system). • For safe operation, the installation must be protected by a fuse of a rating not exceeding 16 A and equipped with a residual-current circuit breaker in accordance with applicable national standards. • The disconnection of the appliance from the mains power supply must always be performed from the mains socket and not from the appliance itself. • Mains-powered appliances are equipped with a safety-tested mains cable designed for use in the country of operation and may only be connected to a grounded shockproof socket, otherwise electric shock may occur. • Make sure that the mains socket on the appliance or the mains socket of the house installation is readily accessible for the user so that the mains cable can be pulled out of the socket in an emergency. | <ul style="list-style-type: none"> • In accordance with IEC 62368-1, it must be possible to disconnect the appliance from the supply voltage from a point other than the appliance itself (e.g., from the primary circuit breaker). • The power supply plug may only be fitted or dismantled while the appliance is isolated from the power supply (e.g., disconnected at the primary circuit breaker). • Supply cables must be adequately secured and have an adequate wire gauge size. <p style="text-align: center;"><i>Connection Cable Wire Gauge:</i> $1\text{ mm}^2 - 2.5\text{ mm}^2$ 17 AWG – 13 AWG</p> <ul style="list-style-type: none"> • The power supply of the device must have a suitable disconnection mechanism such as a switch. This disconnection mechanism must be readily accessible in the vicinity of the appliance and marked accordingly as a cut-off mechanism for the appliance. |

4.5 Connection of Protective Earth Conductor/Grounding



ATTENTION!



In order to ensure that the device can be operated safely and to meet the requirements of IEC 62368-1, the device must be correctly connected to the protective earth conductor via the protective earth connection terminal.



If an external ground connection is provided on the housing, it must be connected to the grounding busbar (earthing busbar) for safety reasons before connecting the power supply. Like this, any possible leakage current on the housing is safely discharged to earth.

The screw, washer and toothed lock washer necessary for mounting the grounding cable are located at the grounding point of the housing. A grounding cable is not included in the contents of delivery.

Note:

Please use a grounding cable with cross-section $\geq 1.5 \text{ mm}^2$, as well as a suitable grounding clamp/lug. Always ensure that the connection is properly crimped!

4.6 Safety During Operation



WARNING!

Avoiding Short-Circuits

Protect the device against all ingress of solid objects or liquids. Ingress presents a risk of electric shock or short-circuiting!

Ventilation Slots

Ensure that the ventilation slots are clean and uncovered at all times. Blocked ventilation slots may cause heat to be trapped in the system, resulting in overheating. This may cause your device to malfunction or fail.

Appropriate Usage

The device is only deemed to be appropriately used and EMC limits (electromagnetic compatibility) are only deemed to be observed if the chassis cover is properly fitted (thus ensuring that the device is properly cooled, fire-safe, and shielded against electrical, magnetic and electromagnetic fields).



Switching the Device Off in the Event of a Malfunction or when Repairs are Required

It is not sufficient to simply switch off the device itself in order to disconnect the power supply. If the device is malfunctioning, or if repairs become necessary, the device must be isolated from all power supplies immediately.

To do so, follow the procedure below:

- Switch off the device from the unit itself.
- Pull out all power supply plugs.
- Inform the person or department responsible for your electrical installation.
- If your device is connected to an Uninterruptible Power Supply (UPS), it will remain operational even after pulling the UPS power cable from the mains socket. In this case, you will need to shut down your UPS in accordance with the user documentation of your UPS system.

4.7 Safety During Maintenance



WARNING!

When modifying the device in any way, only use components that are approved for use with the system. Failure to comply with this requirement may result in violations of EMC or safety standards and cause the device to malfunction.

When modifying or removing components approved for the system, the force required to remove the components (approx. 60 N) presents a risk of injury to the hands. Information on which components are approved for installation can be obtained from Meinberg Technical Support.

The device must not be opened. Repairs to the device may only be performed by the manufacturer or authorized personnel. Improperly performed repairs expose the user to considerable risk (electric shock, fire hazard).



- Danger from moving parts. Keep away from moving parts.



- Parts of the device may get very hot during operation. Do not touch the surfaces of these! Switch off the device and allow it to cool if necessary before installing or removing any components.

4.8 Handling of Batteries



WARNING!

The lithium battery on the receiver modules has a life of at least ten years. Should it be necessary to replace it, please note the following:

Improper handling of the battery can lead to an explosion or to a leakage of flammable liquids or gases.

- Never short-circuit the battery.
- Never attempt to recharge the battery.
- Never throw the battery into a fire.
- The battery must only be exposed to the barometric pressure range specified by the battery manufacturer.
- The battery must only ever be replaced with one of the same type or a comparable type recommended by the manufacturer. The battery must only be replaced by the manufacturer or an authorized technician.
- Never dispose of the battery in a mechanical crusher or shredder, or in an open fire or furnace.

Please consult your local waste disposal regulations for information on how to dispose of hazardous waste.



IMPORTANT!

The battery is used to power components such as the RAM and the reserve real-time backup clock for the reference clock.

If the battery voltage drops below 3 V DC, Meinberg recommends having the battery replaced. If the battery voltage drops below the specified minimum, the following behavior may be observed in the reference clock:

- The reference clock may have the wrong date or wrong date upon power-up
- The reference clock repeatedly starts in Cold Boot mode
- Some of the configurations saved for the reference clock may be lost

4.9 Safety Information for SFP Modules

This safety information describes how the SFP modules recommended by Meinberg should be handled to ensure safe usage. These SFP modules are hot-pluggable input/output devices (I/O devices) that are connected to a network via a fiber optic or electrical connection. The safety information below must be read and heeded before installing an SFP module in a Meinberg device, before setting up a Meinberg device equipped with SFP modules for use, or before performing maintenance on such a Meinberg device.



CAUTION!

The SFP modules recommended by Meinberg are equipped with a Class 1 laser.

Risk of injury from laser radiation!

- Only use fiber optic SFP modules that are compliant with the definition of a Class 1 laser in accordance with IEC standard 60825-1.
- Fiber optic products that are not compliant with this standard may emit radiation capable of causing eye injuries.
- Never look into an unconnected connector of a fiber optic cable or an unconnected SFP port.
- Unused fiber optic connectors should always be fitted with a suitable protective cap.
- This device may be installed, replaced, and maintained only by trained and qualified personnel.



ATTENTION!

- The safety information and manufacturer specifications relating to the SFP modules used must be heeded.
- The SFP module used must be capable of providing protection against voltage spikes in accordance with IEC 62368-1.
- The SFP module used must be tested and certified in accordance with applicable standards.

4.10 Cleaning and Care



ATTENTION!

Never clean the device using liquids! Water ingress is a significant safety risk for the user (e.g., electric shock).

Liquids can cause irreparable damage to the electronics of the device! The ingress of liquids into the device chassis may cause short circuits in the electronic circuitry.

Only clean with a soft, dry cloth. Never use solvents or cleaners.

4.11 Prevention of ESD Damage



ATTENTION!

An ESDS device (electrostatic discharge-sensitive device) is any device at risk of damage or malfunction due to electrostatic discharges (ESD) and thus requires special measures to prevent such damage or malfunction. Systems and modules with ESDS devices usually bear the following symbol:



Symbol Indicating Devices with ESDS Components

The following measures will help to protect ESDS components from damage and malfunction.

When preparing to dismantle or install devices:

Ground your body (for example, by touching a grounded object) before touching sensitive devices.

Ensure that you wear a grounding strap on your wrist when handling such devices. These straps must in turn be attached to an uncoated, non-conductive metal part of the system.

Use only tools and devices that are free of static electricity.

When transporting devices:

Devices must only be touched or held by the edges. Never touch any pins or conductors on the device.

When dismantling or installing devices:

Avoid coming into contact with persons who are not grounded. Such contact may compromise your connection with the earth conductor and thus also compromise the device's protection from any static charges you may be carrying.

When storing devices:

Always store devices in ESD-proof ("antistatic") bags. These bags must not be damaged in any way. ESD-proof bags that are crumpled or have holes cannot provide effective protection against electrostatic discharges.

ESD-proof bags must have a sufficient electrical resistance and must not be made of conductive metals if the device has a lithium battery fitted on it.

4.12 Return of Electrical and Electronic Equipment



ATTENTION!

WEEE Directive on Waste Electrical and Electronic Equipment 2012/19/EU
(WEEE Waste Electrical and Electronic Equipment)

Waste Separation

Product Category: According to the device types listed in Annex I of the WEEE Directive, this product is classified as "IT and Telecommunications Equipment".



This product satisfies the labeling requirements of the WEEE Directive. The product symbol on the left indicates that this electronic product must not be disposed of in domestic waste.

Return and Collection Systems

When disposing of your old equipment, please use the national return or collection systems available to you. Alternatively, you may contact Meinberg, who will provide further assistance.

The return of electronic waste may not be accepted if the device is soiled or contaminated in such a way that it potentially presents a risk to human health or safety.

Return of Used Batteries

The EU Battery Directive prohibits the disposal of batteries marked with the WEEE trashcan symbol above in household waste.

5 Before you start

5.1 Text and Syntax Conventions

This chapter briefly describes the text and syntax conventions used in this manual.

Menu description

Example web interface menu "Network"

Submenu "Network → Physical Network Configuration"

Tab in a submenu "Network → Network Interfaces → IPv4"

Menu navigation is logically separated by the right arrow.

Services

The services running on the system are shown in italics.

Example: NTP-Deamon: *ntpd*

Cross references in the document:

Cross-references in the document are displayed in dark blue font - e.g.: see chapter Support Information

Selection Options and Logical Groups:

Selection options, e.g. in a drop-down menu, are underlined and then briefly described. If several parameters are combined in a menu to logical groups, these are also underlined and displayed in bold font - e.g. PTP status → **Parent Datasets** .

Example:

Menü PTP (IEEE1588) Settings → Operation Mode

Multicast Master

...

Terminal

```
# Output via a terminal window is displayed
# in a grey box with monospace font.
```

5.2 Abbreviation List

| | | | |
|-----------|---|-----------|--|
| AFNOR | Association Francaise de Normalisation time codes | IP | range (PTP) Internet Protocol |
| AC | Alternating Current | IP 20 | Protection Class 20 |
| ASCII | American Standard Code for Information Interchange | IRIG | Inter-range instrumentation group time codes |
| BMC | Best Master Clock | LCD | Liquid Crystal Display |
| BNC | Bayonet Neil Councilman connector | LDAP(S) | Lightweight Directory Access Protocol |
| Bps | Bytes per second | LED | Light-Emitting Diode |
| bps | Bits per second | LINUX | Unix-like multi-user computer operating system |
| CAT5 | Standard Network Cable | LIU | Line Interface Unit- an module for generation E1/T1 Signals, both MBit/s (framed) and Clock (unframed) |
| CET | Central European Time | LNE | Local Network Extention, additional Ethernet Ports |
| CLI | Command Line Interface | MAC | Media Access Control |
| DB9 | Connector do type D-subminiature | MD5 | Message-Digest cryptographic hash function |
| DC | Direct Current | MESZ | Middle European Summer Time |
| DCF77 | Is a longwave time signal. DCF77 stands for D=Deutschland (Germany), C=long wave signal, F=Frankfurt, 77=frequency: 77.5 kHz. | MEZ | Middle European Time |
| DCFMARK | Single pulse with a programmable date and time | MIB | Management Information Base |
| DHCP | Dynamic Host Configuration Protocol | MRS | Multi Reference Source |
| DNS | Domain Name Server | MSF | Time signal transmitter in Anthorn, UK |
| DSCP | Differentiated Services Code Points | NIST | National Institute of Standards and Technology |
| DST | Daylight Saving Time | NMEA | Communication standard from National Marine Electronics Association |
| E1 | European digital transmission signal at 2.048 MHz used in telecommunication networks. | NTP | Network Time Protocol |
| E2E | End-to-end | NTPD | NTP Daemon |
| ETH | Ethernet | OSV | Original Shipped Version (Firmware) |
| FTP | File Transfer Protocol | OUT | Output |
| FW | Firmware | P2P | Peer-to-Peer |
| GE / GbE | Gigabit Ethernet | PLC | Programmable Logic Controller |
| GLONASS | GLOBAL NAVIGATION Satellite System from Russian Aerospace Defense Forces | PLL | Phase Locked Loop |
| GND | Ground (Connector) | PPM | Pulse per Minute |
| GNSS | Global Navigation Satellite System (GPS, GLONASS, Galileo, Beidou) | PRP | Parallel Redundancy Protocol |
| GOAL | GPS Optical Antenna Link | PPS | Pulse per Second |
| GPS | Global Positioning System (USA) | PPH | Pulse per Hour |
| GSM | Global System for Mobile Communications | PTB | Physical - Technical Institute Braunschweig / Germany |
| HMI | Human-Machine Interface | PTP | Precision Time Protocol |
| HP | Horizontal Pitch - is a unit measure the horizontal width of rack mounted electronic equipment | RAM | Random Access Memory |
| HPS | High Performance Synchronization PTP/NTP/SyncE GBit module | RF | Frequency of radio waves, from 3kHz to 300GHz |
| HSR | High-availability Seamless Redundancy | RG58 | Standard coaxial cable used to connect an antenna and a receiver |
| HTTP | Hypertext Transfer Protocol | RJ45 | Ethernet Connector with 8 conductors |
| HTTPS | Hypertext Transfer Protocol Secure | RMC | Remote Monitoring Control |
| IEC | International Electrotechnical Commission | RoHS | Restriction of Hazardous Substances |
| IED | Intelligent Electronic Devices | RPS | Redundant Power Supply |
| IEEE | Institute of Electric and Electronic Engineers | RS232/485 | Serial port levels |
| IEEE 1588 | Protocol for high-precision synchronization in nanosecond | RSC | Redundant Switch Control unit |
| | | RX | Receiving Data |
| | | SBC | Single Board Computer |
| | | SDU | Signal Distribution Unit |

| | | | |
|---------|--|------|--|
| SHA-1 | Secure Hash Algorithm 1 | | AFNOR or IEEE1344 codes |
| SMB | Subminiature coaxial connector | T1 | North American telecommunication signal at 1.544 MHz frequency |
| SNMP | Simple Network Management Protocol | | |
| SNTP | Simple Network Time Protocol | TCP | Transmission Control Protocol |
| SMTP | Simple Mail Transfer Protocol | TTL | Transistor-to-Transistor Logic |
| SPS | Standard Positioning System | TX | Data Transmission |
| SSH | Secure SHell network protocol | U | Unit - is a unit measure the vertical height of rack mounted electronic equipment. |
| SSU | Synchronization Supply Unit, specific clock used in telecommunication networks | | |
| SSM | Sync Status Messages, clock quality parameters in telecommunication networks. | UDP | User Datagram Protocol |
| | | UMTS | Universal Mobile Telecommunications System |
| ST | Bayonet-lock connector | UNIX | Multitasking, multi-user computer operating system |
| Stratum | Value defines the NTP hierarchy | UTC | Universal Time Coordinate |
| SYSLOG | Standard for computer data logging | VLAN | Virtual Local Area Network |
| TACACS | Terminal Access Controller Access Control System | WWVB | Time signal radio station Fort Collins, Colorado (USA) |
| TCG | Time Code Generator | | |
| TCR | Time Code Receiver for IRIG A/B, | | |

5.3 Required Tools

| LANTIME IMS SERIES | | | | | | | |
|-----------------------|---------------|----------------|----------------|---------------|----------------|-------------------------------|-------------------|
| | LANTIME M1000 | LANTIME M1000S | LANTIME M2000S | LANTIME M3000 | LANTIME M3000S | LANTIME M4000 | LANTIME M500 |
| Mounting Rackears | TORX T20 | TORX T20 | TORX T20 | TORX T20 | TORX T20 | TORX T20 | X |
| Mounting DIN rail | X | X | X | X | X | X | Phillips PH1 x 80 |
| Replacing IMS modules | TORX T8 | TORX T8 | TORX T8 | TORX T8 | TORX T8 | TORX T8 | TORX T8 |
| FAN Installation | TORX T8 | TORX T8 | TORX T8 | TORX T8 | X | TORX T8 Flat head Screwdriver | X |

| LANTIME SERIES | | | | | | | |
|-------------------|-------------------|--------------|--------------|-------------------|--------------|--------------|----------|
| | LANTIME M100 | LANTIME M200 | LANTIME M300 | LANTIME M400 | LANTIME M600 | LANTIME M900 | SyncFire |
| Mounting Rackears | X | TORX T20 | TORX T20 | X | TORX T20 | TORX T20 | X |
| Mounting DIN rail | Phillips PH1 x 80 | X | X | Phillips PH1 x 80 | X | X | X |
| Replacing Modules | X | X | X | X | X | TORX T8 | TORX T10 |



Figure: Required tools from left to right - INBUS 2,5mm, Phillips PH1 x 80, Flat head Screwdriver, TORX T20, TORX T8

5.4 Preparing Installation

Meinberg IMS LANTIME systems are designed for installation in 19-inch racks or 35mm rail mount. Rack systems come with all necessary accessories (mounting brackets, screws, adapters for power supply ...). For installations in regions outside of Germany that have other standards (e.g. for power supply connections), please specify exactly which adapters or cables you need to put the device into operation when ordering.

Before unboxing the system, make sure that there is sufficient space in the built-in cabinet to ensure safe ventilation of the system. Avoid dirt and dust during installation.



Caution!

To avoid damage to the system and personal injury, please make sure to follow the safety instructions in this manual.

5.5 Unboxing the Device

After unpacking the LANTIME time server, please check the contents for completeness – regarding to the included packing list.

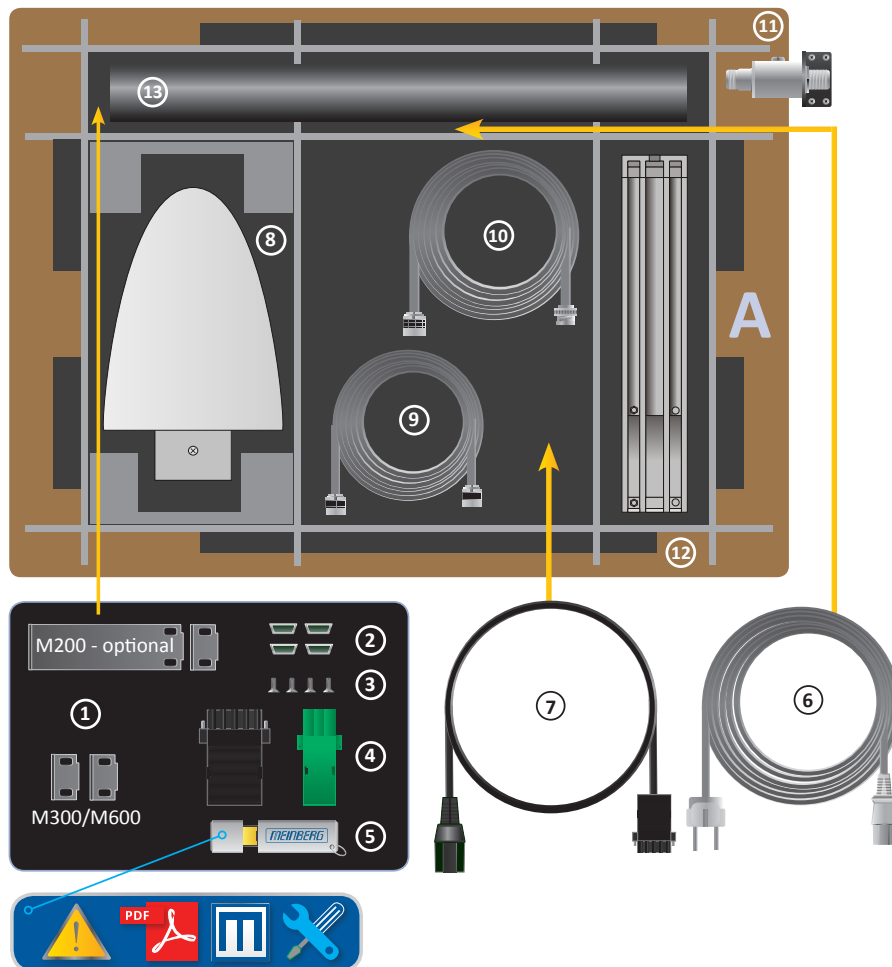

A LANTIME Package Contents

1. Assembly brackets for 19 Inch rack mounting (optional for LANTIME M200)
2. Protection spacer (M200 / M300 / M600)
3. Screws for brackets (M200 / M300 / M600)
4. 3-pin DFK connector or 5-pin DFK connector (additional connector in case of AC/DC or DC power supply)
5. USB stick with software and documentation
6. Power cord (only in case of AC power supply)
7. Option: power cable with 5-pin connector

Only with delivered Antenna

8. Antenna
9. Optional: cable for surge voltage protector
10. Antenna cable
11. Optional: surge voltage protector with bracket
12. Brackets for pole or wall mounting
13. Pole for antenna mounting (GPS Antenna)

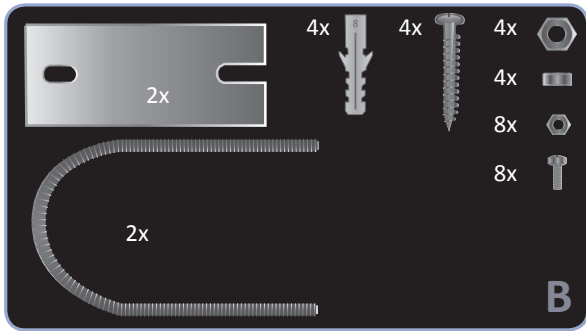

B Mounting Kit for GPS Antenna
(wall or pole mounting)

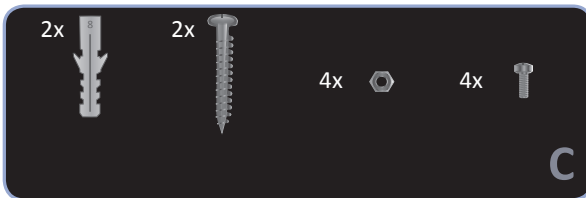

C Mounting Kit for Long Wave Antenna
(wall mounting)



Information:

Please read the safety instructions and the manual carefully to familiarize yourself with the safe and proper handling of electronic devices.

The product documentation can be found on the USB Flash Memory.

5.6 Disposal of Packaging Materials



The packaging materials we use are fully recyclable:

| Material | Use for | Disposal |
|--------------------------------------|--|-----------------|
| Polystyrol | packaging frame/filling material (polystyrene peanuts, bubble wrap) | Recycling Depot |
| PE-LD Polyethylene low density | accessories packaging | Recycling Depot |
| Cardboard | shipping packaging, accessories packaging | Paper recycling |

6 System Installation

19 inch rackmount

Mounting brackets and fixing screws are included in the scope of delivery of a rackmount system. If the system is supplied with an antenna and antenna cable, it is advisable to first mount the antenna in a suitable location (see chapter Antenna Mounting) and lay the antenna cable. The power supply cable and the network cable should also be available at the installation site before the system is installed. Make sure that all necessary adapters for connecting the device are available. Make sure that the voltage is disconnected from the power source during installation.

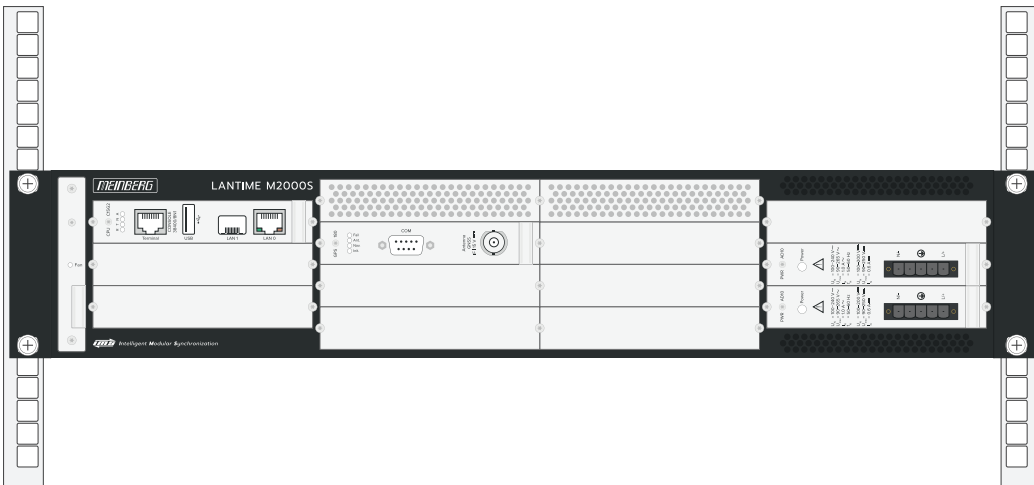

Figure: M2000S rack mount. The screws for rack mounting are not included in the delivery.

6.1 Antenna Connection

There are two types of radio signals commonly used for timing applications: **satellite signals from Global Navigation Satellite Systems (GNSS)**, and **long wave signals** from specific time code transmitters operated by some countries.

Most GNSS signals can be received world-wide, while long wave signals can only be received up to a certain distance around the transmitting station. Also, GNSS receivers can usually track the signals from several satellites at the same time, so the signal propagation delay can be determined and compensated automatically, while long wave receivers usually receive only the signal from a single station. Last but not least the available bandwidths and signal propagation characteristics are another reason why GNSS reception usually yields a higher degree of time accuracy than long wave reception.

A detailed description of the reception modes of our reference clocks and instructions for antenna installation can be found in our LTOS firmware manual: <http://www.mbg.link/doce-fw-ltos> in chapter "Antenna and Receiver Information".

The following table shows the available receiver types from Meinberg

| Type | Receiver | Systems | Antenna / signal reference |
|--------|-----------------------------------|---------------------------------|--|
| GPS | GPS Clock | GPS | GPSANT / Converter |
| GNS | GNS Clock | GPS, GLONASS Galileo, BeiDou | GNSS antenna (up to three systems in parallel) |
| GNS-UC | GNS-UC Clock with Up-Converter | GPS, GLONASS | GPSANT / Converter |
| GNM | GNM Clock | GPS, GLONASS Galileo, BeiDou | Multiband-GNSS-Antenne (up to four systems in parallel) |
| PZF | PZF Clock | DCF77 | AW02 long wave outdoor antenna |
| MSF | MSF Clock | MSF (UK) | AW02-60 long wave outdoor antenna |
| WVB | WWVB Clock | WWVB (US) | AW02-60 long wave outdoor antenna |
| TCR | TCR Clock | Time code reader | Time code generator |
| RDT | no clock module | Network | ext. reference, ext. NTP server |

6.1.1 Mounting the Antenna

6.1.1.1 Installation of the GPS Antenna



Danger!

Do not mount the antenna without an effective fall arrester!

Danger of death from falling!

- Ensure that you work safely when installing antennas!
- Never work without an effective fall arrester!



Danger!

Do not work on the antenna system during thunderstorms!

Danger of death from electric shock!

- Do not carry out any work on the antenna system or the antenna cable if there is a risk of lightning strike.
- Do not carry out any work on the antenna system if it is not possible to maintain the prescribed safe distance to exposed lines and electrical substations.

Selecting the Antenna Location

To avoid difficulties with synchronization, select a location that allows for an unobstructed view of the sky so as to ensure that enough satellites can be found. The line of sight between the antenna and satellites should not be obstructed in any way. The antenna must also not be installed under power lines or other electrical lighting or power circuits.

Installation Conditions for Optimum Operation:

- clear view of 8° above the horizon or
- clear view towards equator (if clear view of 8° not possible) or
- clear view between 55th north and 55th south parallels (satellite orbits).



Information:

Problems may arise if all of these views are obstructed, as four satellites must be located to calculate a new position.

Important Information Regarding Surge Protection

The following illustration is a visual representation of where there is a risk of hazardous voltage surges in the cable route (from antenna to Meinberg system). The examples below explain how you can protect your Meinberg system from these.

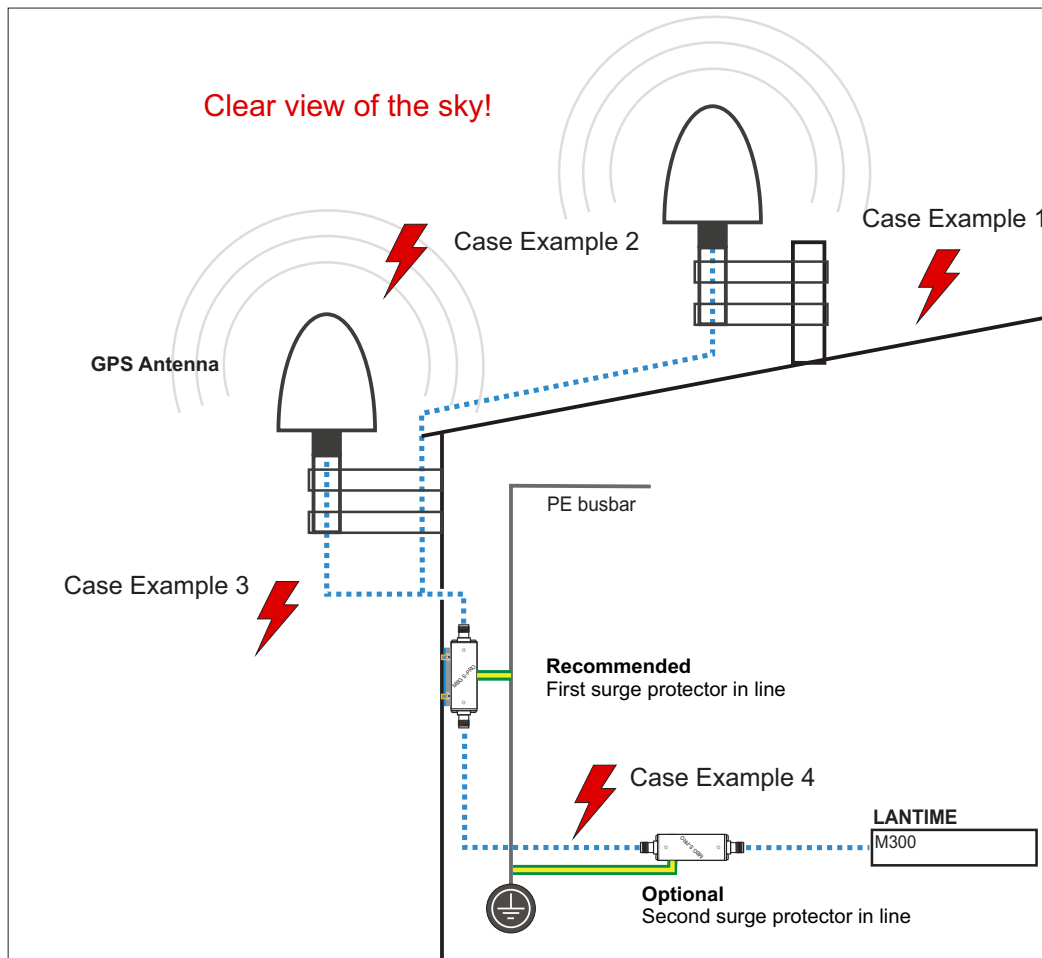

Case Example 1:

An indirect lightning strike near the antenna or coaxial cable may induce transient voltages ("spikes" or "surges"). These spikes can be carried via the coaxial cable to the inside of the building and consequently to the system's receiver. It is therefore strongly recommended to have the surge protector installed at the point directly after the cable enters the building.

Case Example 2:

In the event of a direct lightning strike on the antenna, the resultant transient voltage may be discharged via the PE busbar (GNS L1 antenna only). This prevents the transient voltage from being carried to the coaxial cable and subsequently to the system's receiver.

Case Example 3:

If the length of the coaxial cable between the antenna and point of entry into the building is rather long (e.g., 10 meters), there is a greater risk of transient voltages being introduced into the antenna cable as a result of lightning strike. So the installation of a surge protector immediately after the point of entry into the building is also strongly recommended here.

Case Example 4:

If the cable leading from the point of entry into the building to the Meinberg system is laid together with other cables (for example in a cable duct alongside high-voltage cables), transient voltages may "leak" into the antenna cable, causing damage to your system. To prevent this, a second surge protector can optionally be installed in the line just before the device.

Mounting the Antenna

1.

Use the included mounting kit to mount the antenna at a distance of 50 cm from other antennas, either on a vertical pole of a diameter of no more than 60 mm, or directly onto a wall.

The antenna cable should then be connected to the Type-N connector of the antenna. Feed the other end of the cable into the building through the wall.

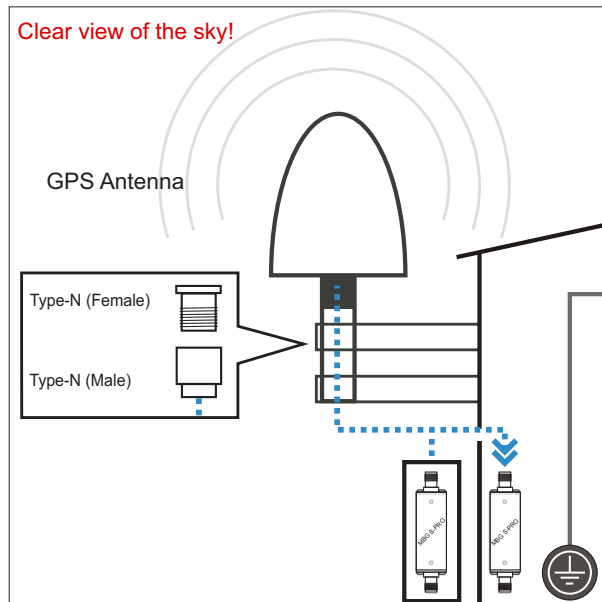

Information:

Make sure that the maximum cable length is not exceeded when installing the antenna cable between the antenna and receiver. The maximum length will depend on the type of cable used (RG213, RG58) and its attenuation factor.

2.

Voltage surges (e.g., caused by lightning strike) may be transmitted along the antenna cable and cause damage to the receiver. Using a MBG S-PRO surge protector can help to protect your receiver against such surges.

If installed in a waterproof housing, the MBG S-PRO can be installed outdoors. However, Meinberg recommends installing the surge protector indoors—as closely to the entrance point of the antenna cable as possible—in order to minimize the risk of surge damage (such as that caused by lightning strike).

Connect the other end of the antenna cable to the female connector of the surge protector.

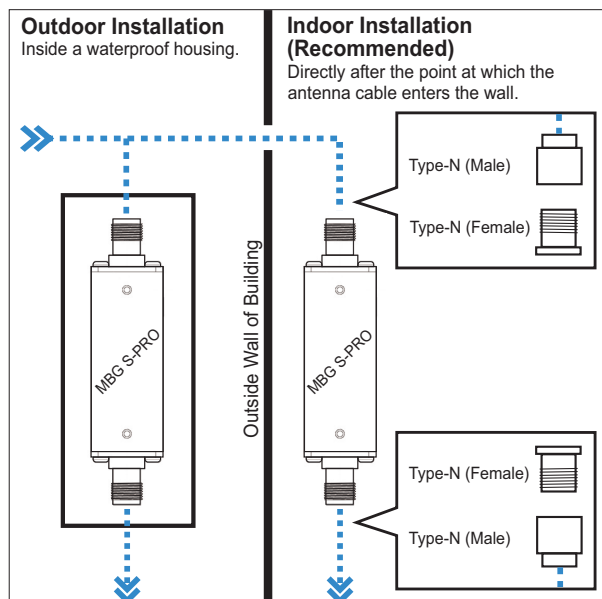

3.

To ground the antenna cable, connect the surge protector to a grounding busbar using a grounding conductor (see illustration).

Once installation is complete, connect the other end of the antenna cable to the surge protector female connector.

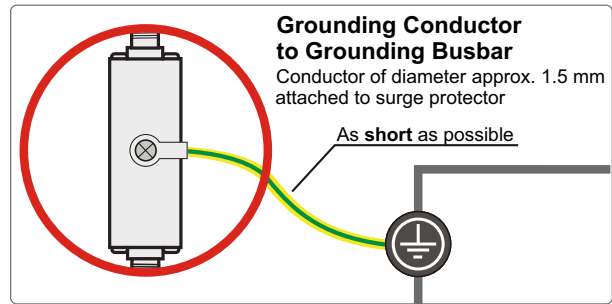

4.

The next step is to connect the supplied coaxial cable from the surge protector to the receiver.

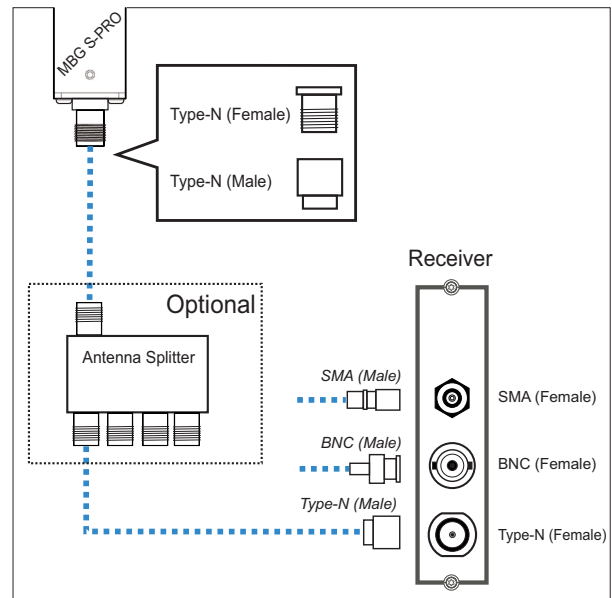

Optional Antenna Splitter

Multiple receivers can be connected to one antenna using the antenna splitter. When doing so, be aware that the total distance, comprising the cable from the antenna to the splitter, and from there to the receiver, must not exceed the maximum cable length. The splitter may be installed at any location between the surge protector and the receivers.



Information:

Please note for installation purposes that GNSS L1 components cannot be directly connected to or used with a Meinberg GPS antenna distributor.

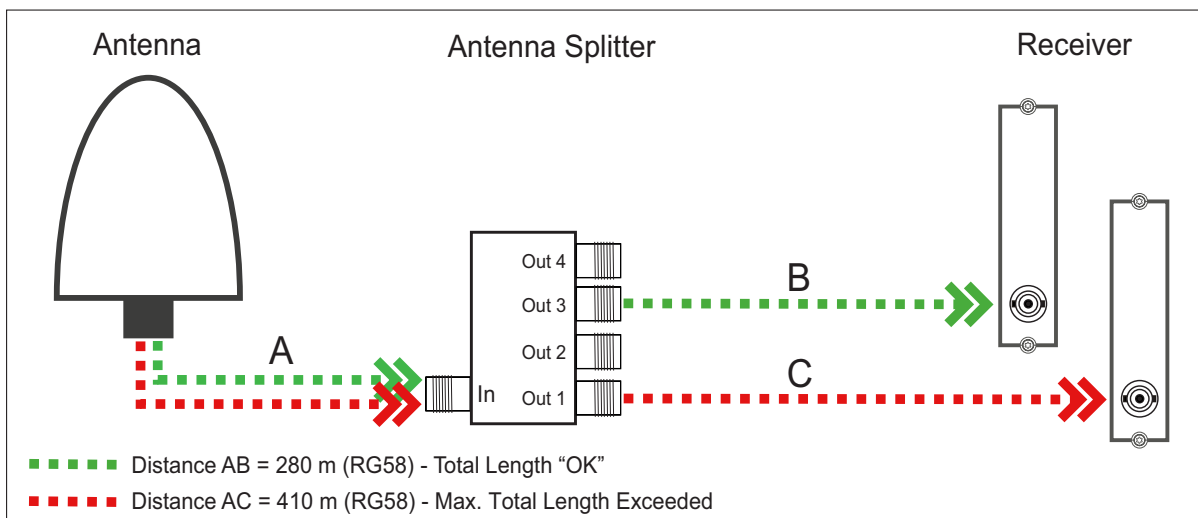

Compensating for Signal Propagation Delay in the Antenna Cable

To enable the connected receiver to compensate for the signal propagation delay inherent in the antenna cable, you will need to enter either the length of your antenna cable in meters or the offset time in nanoseconds into your receiver.

Antenna Cable Length (m):

The satellite signal reception is delayed as a result of coaxial cable used.

| Cable | Delay | Usage |
|-------|--------|------------------------------|
| RG58U | 5 ns/m | For GPS and GNS-UC receivers |
| H155 | 4 ns/m | For GNS and GNM receivers |

The cable length entered (from antenna to receiver) is used by the system to calculate the delay time and to automatically compensate for propagation delay. A value of 20 m is set by default.

When using a different type of coaxial cable, please use the "By Delay" option. You will need to calculate the delay yourself using the information provided in the product specifications provided by the manufacturer of your coaxial cable.

6.1.1.2 GNSS Antenna Installation

Two different antennas are available for our combined GPS/GLONASS/Galileo/BeiDou satellite receivers that are each designed to fulfill different tasks or applications.

The active Multi-GNSS L1 antenna is the standard accessory and can receive signals from the GPS, GLONASS, Galileo, and BeiDou satellite systems. This antenna is ideal for fixed-location systems, operates using a 5 V DC supply voltage supplied by the receiver, and features an integrated surge protector.

For mobile applications, such as cars, RVs, vans, ships, trains, and aircraft, we recommend the use of the RV-76G, an active GNSS antenna that is suitable for direct installation in an enclosure (chassis, panels, etc.)

6.1.1.3 Installation of the Multi-GNSS Antenna



Danger!

Do not mount the antenna without an effective fall arrester!

Danger of death from falling!

- Ensure that all necessary safety measures are taken when installing an antenna!
- In particular, never work without an effective fall arrester!



Danger!

Do not work on the antenna system during thunderstorms!

Danger of death from electric shock!

- Do not carry out any work on the antenna system or the antenna cable if there is a risk of lightning strike.
- Do not carry out any work on the antenna system if it is not possible to maintain the prescribed safe distance to exposed lines and electrical substations.

Selecting the Antenna Location

To avoid difficulties with synchronization, select a location that allows for an unobstructed view of the sky so as to ensure that enough satellites can be found. The line of sight between the antenna and satellites should not be obstructed in any way. The antenna must also not be installed under power lines or other electrical lighting or power circuits.

Installation Conditions for Optimum Operation:

- clear view of 8° above the horizon or
- clear view towards equator (if clear view of 8° not possible) or
- clear view between 55th north and 55th south parallels (satellite orbits).



Information:

Problems may arise if all of these views are obstructed, as four satellites must be located to calculate a new position.

Important Information Regarding Surge Protection

Information about Meinberg surge protection can be found in the [chapter Installation of the GPS Antenna](#) .

Mounting the Antenna

1.
Use the included mounting kit to mount the L1 antenna at a distance of 50 cm from other antennas on a vertical pole of a diameter of between 60 mm and 215 mm (2½"-8½").

The antenna cable should then be connected to the Type-N connector of the antenna.

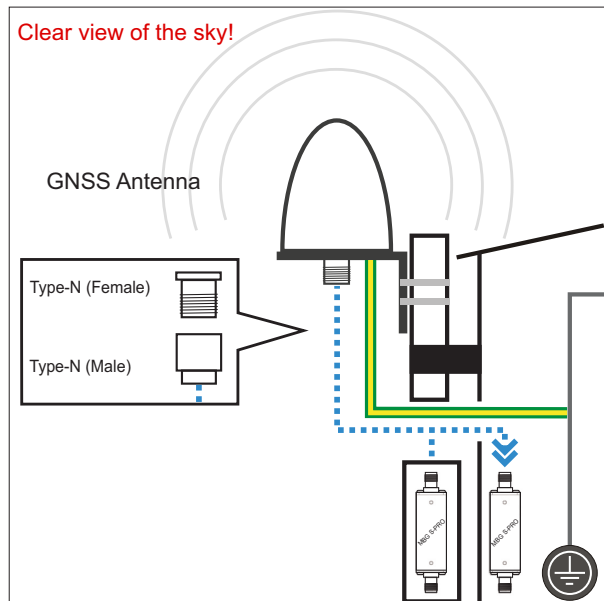

Information:

Make sure that the maximum cable length is not exceeded when installing the antenna cable between the antenna and receiver. The maximum length will depend on the type of cable used (RG213, RG58) and its attenuation factor.

2.

Voltage surges (e.g., caused by lightning strike) may be transmitted along the antenna cable and cause damage to the receiver. Using an MBG S-PRO surge protector can help to protect your receiver against such surges.

If installed in a waterproof housing, the MBG S-PRO can be installed outdoors. However, Meinberg recommends installing the surge protector indoors—as closely to the entrance point of the antenna cable as possible—in order to minimize the risk of surge damage (such as that caused by lightning strike).

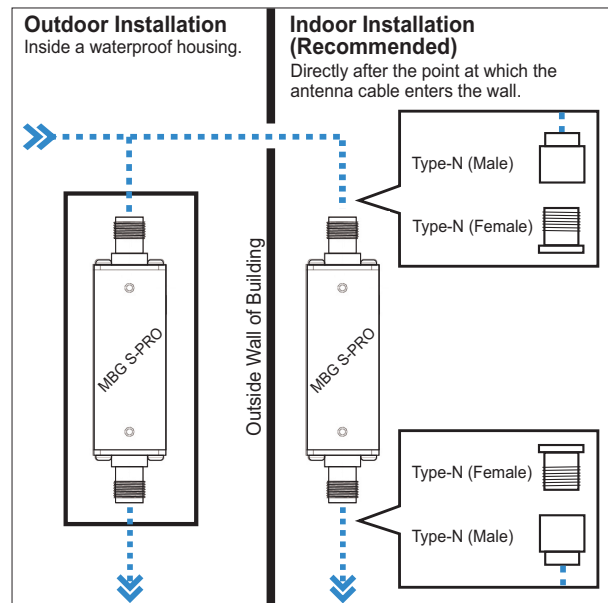

3.

To ground the antenna cable, connect the surge protector to a grounding busbar using a grounding conductor (see illustration).

Once installation is complete, connect the other end of the antenna cable to the surge protector female connector.

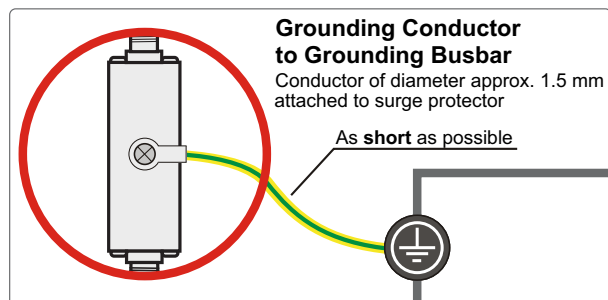

4.

The next step is to connect the supplied coaxial cable from the surge protector to the receiver.

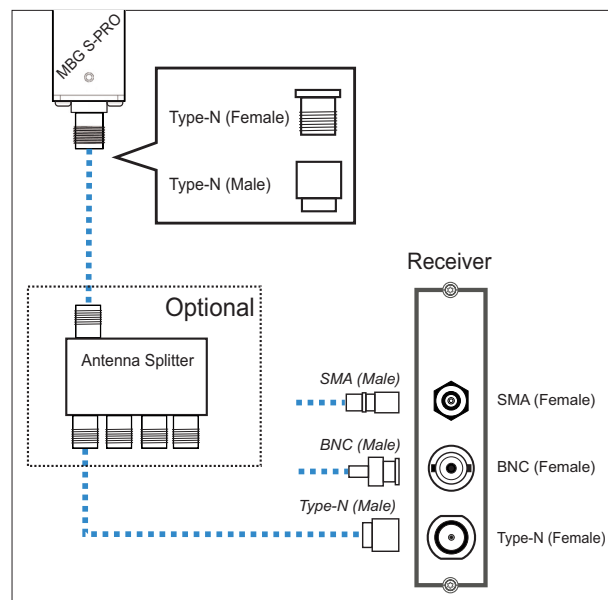

Optional Antenna Splitter

Multiple receivers can be connected to one antenna using the antenna splitter. When doing so, be aware that the total distance, comprising the cable from the antenna to the splitter, and from there to the receiver, must not exceed the maximum cable length. The splitter may be installed at any location between the surge protector and the receivers.



Information:

It is not possible to directly connect a Meinberg GPS antenna/converter unit to an L1 antenna splitter.

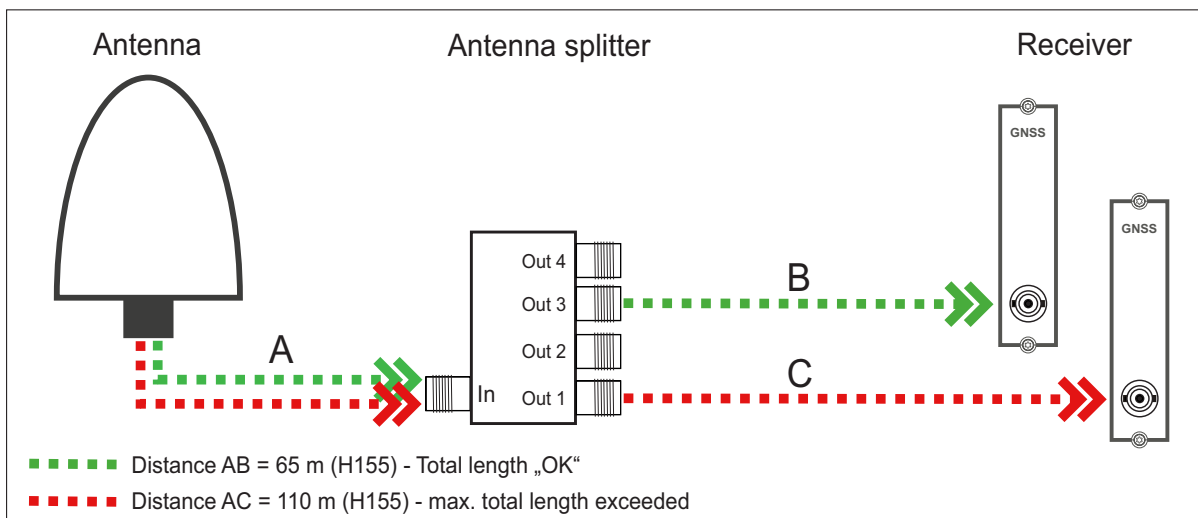

Compensating for Signal Propagation Delay in the Antenna Cable

To enable the connected receiver to compensate for the signal propagation delay inherent in the antenna cable, you will need to enter either the length of your antenna cable in meters or the offset time in nanoseconds into your receiver.

To do so, go to the web interface of your system to the menu "Clock → Status u. Configuration → Miscellaneous".

Antenna Cable Length (m):

The satellite signal reception is delayed as a result of coaxial cable used.

| Cable | Delay | Usage |
|-------|--------|------------------------------|
| RG58U | 5 ns/m | For GPS and GNS-UC receivers |
| H155 | 4 ns/m | For GNS and GNM receivers |

The cable length entered (from antenna to receiver) is used by the system to calculate the delay time and to automatically compensate for propagation delay. A value of 20 m is set by default.

When using a different type of coaxial cable, please use the "By Delay" option. You will need to calculate the delay yourself using the information provided in the product specifications provided by the manufacturer of your coaxial cable.

6.1.1.4 Assembly of the RV-76G GPS/GLONASS Antenna for Mobile Applications

Installation of the Antenna

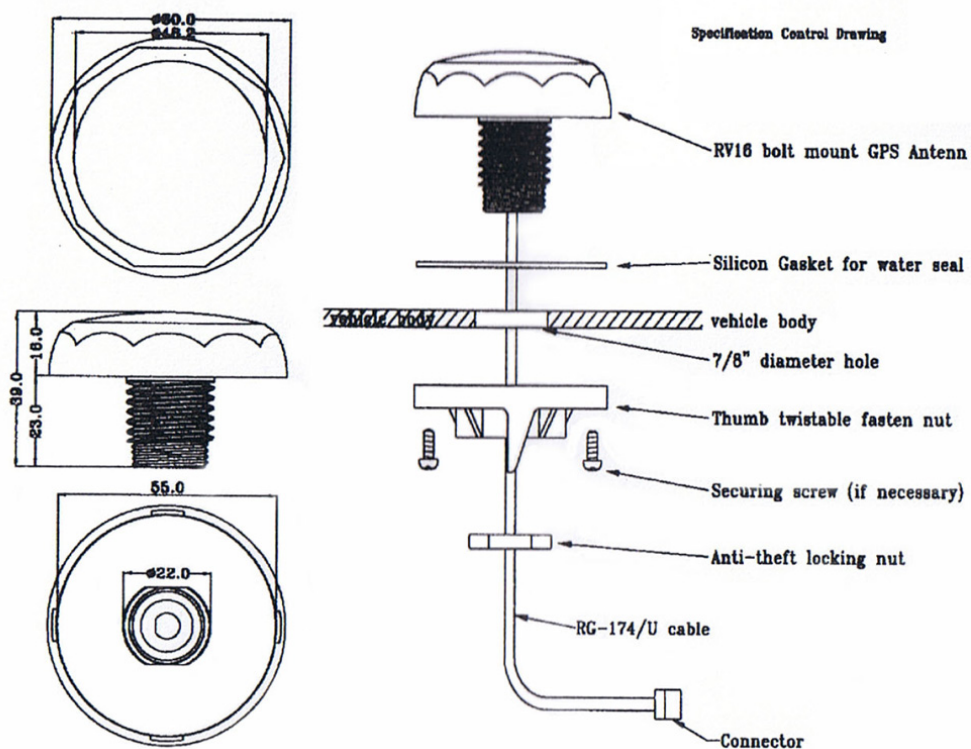

Further Information on the Product

Detailed specifications are provided in the manufacturer's data sheet.

Source: *Datasheet RV-76G_Catalog_V1.0_20130502 (Sanav)*

Download: https://www.meinbergglobal.com/download/docs/other/rv-76g_en.pdf

6.1.1.5 Installation DCF77 Antenna



Danger!

Do not mount the antenna without an effective fall arrester!

Danger of death from falling!

- Ensure that you work safely when installing antennas!
- Never work without an effective fall arrester!



Danger!

Do not work on the antenna system during thunderstorms!

Danger of death from electric shock!

- Do not carry out any work on the antenna system or the antenna cable if there is a risk of lightning strike.
- Do not carry out any work on the antenna system if it is not possible to maintain the prescribed safe distance to exposed lines and electrical substations.

Selection of the Antenna location

At the beginning of each antenna installation, the antenna location should be selected carefully. It decisively determines the receiving quality and thus the availability of the DCF77 signal. If the antenna is not precisely aligned, signal reception and timing accuracy will be affected.

The DCF antenna must be aligned towards Mainflingen near Frankfurt / Main according to the installation conditions mentioned below.

Alignment of DCF77 Antenna

The length of the DCF77 antenna (e.g., AI01, AW02) (see **arrow direction**) should be facing the transmission tower.

DCF77 Antenna

Location: Berlin

DCF77 Transmission Tower

Location: Mainflingen, near Frankfurt am Main
Signal: DCF77 Long Wave

DCF77 Antenna

Location: Milan

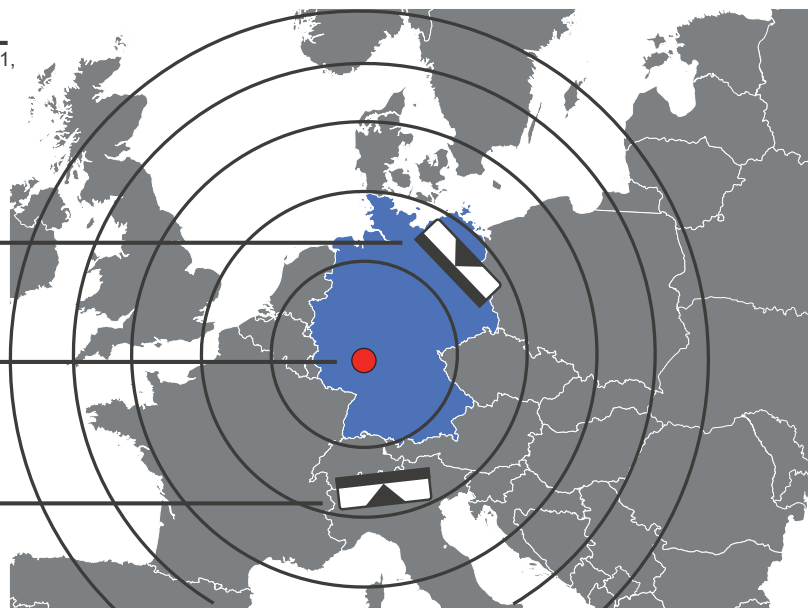

Figure: Antenna installation of a Meinberg AW02 antenna aligned to the DCF77 transmitter mast in Mainflingen (Frankfurt/Main).

A DCF77-reception in buildings is possible, but due to shielding or attenuation the reception quality can be reduced.

Criteria for impaired reception:

- Antenna installation near metallic objects (e.g. reinforced concrete walls, metal facades, thermal insulation glazing etc.)
- Antenna installation near TV or computer monitors
- Antenna installation under or near power lines

Meinberg recommends mounting the antenna outside of buildings. This has the advantage that the signal-to-noise ratio to electronic devices in buildings is usually increased and the reliability of the synchronization is thus significantly improved.

Installation conditions for optimal operation:

- Horizontal mounting of the antenna
- Long side of the DCF77-antenna aligned to the transmission tower (see illustration previous page)
- min. 30 cm distance from all metal objects



Important!

If these installation criteria cannot be met, signal reception may be affected.

Installation

1.

Mount the antenna according to the criteria mentioned above directly on a wall, using the mounting kit included in the delivery.

Now connect the antenna cable to the N standard socket of the antenna.

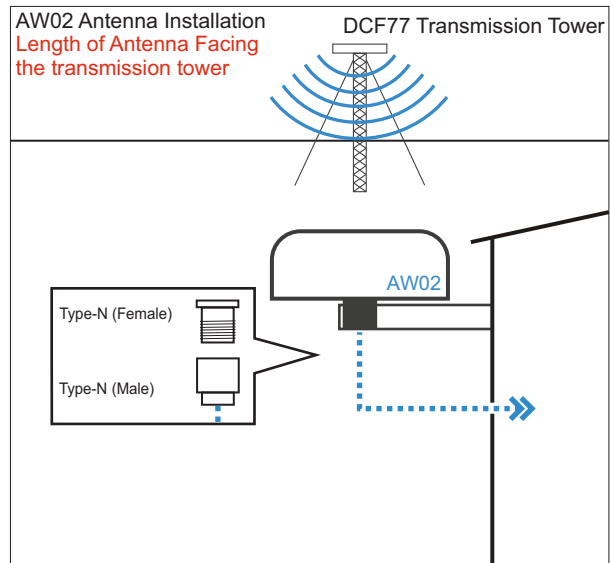

Procedure for antenna alignment:

When aligning your AW02 antenna it does not show itself a visual status of the reception quality of the DCF77 signal.

Meinberg recommends that the alignment and the associated reception quality check be done in a team. A good method for aligning and testing a long wave antenna is to have person 1 (at the antenna) in contact with person 2 (at the receiver).

Step 1

Person 1 rotates the antenna until person 2 reads the minimum field strength value on the front display (if present) or the modulation indicator/ LED does not yet flash every second.

Step 2

Person 1 rotates the antenna by 90° until person 2 notices a maximum reception (field strength value at maximum) or a flashing of the modulation LED every second without intermediate flickering.

However, a high signal level alone is no guarantee of good reception, as it can also be caused by electrical noise in the associated frequency range.

With good reception, the connected DCF reference clock synchronises within three minutes after switching on.

PZF Reference Clocks

IMS-PZF

Field LED (Field) flashes for 10 seconds after switching on

LANTIME with PZF clock

Field strength/correlation value can be checked in the front display and web interface.

**Information:**

Pay attention to the maximum cable length when installing the antenna cable between antenna and receiver. This depends on the cable type used (e.g. RG58) and its attenuation factor.

2.

High voltage peaks (e.g. caused by lightning strikes) can be transmitted via the antenna cable and may cause damage to the receiver. The receiver is protected against these effects by using the MBG S-PRO surge protection.

Being installed in a waterproof housing, the MBG S-PRO is also suitable for outdoor installation. Meinberg recommends the indoor installation, as soon as possible after the antenna cable enters the building to minimize the risk of overvoltage damage, e.g. due to lightning strikes.

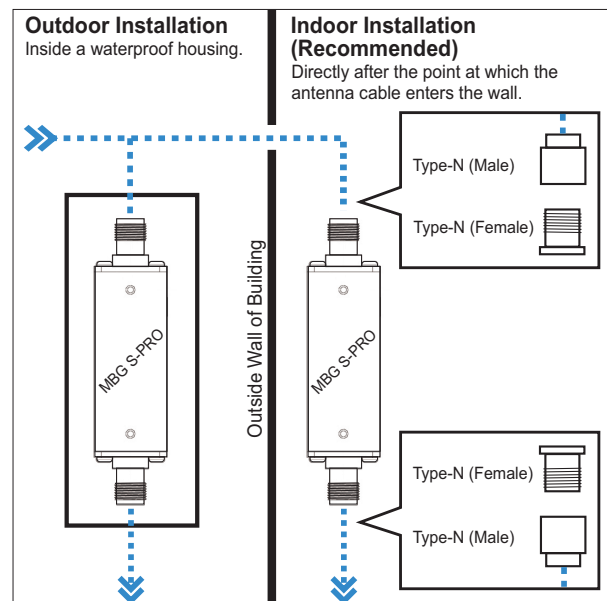

3.

To ground the antenna cable, connect the surge protection with a grounding cable to a equipotential bonding rail (see figure).

After installation, connect the other end of the antenna cable to the socket of the surge protection.

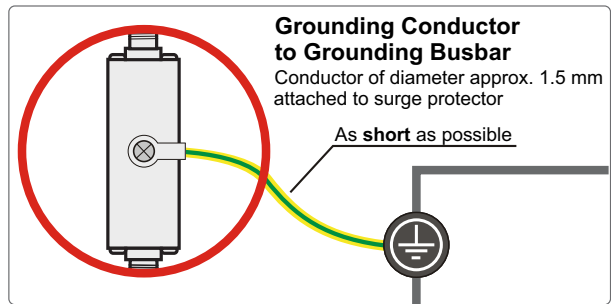

4.

The next step is to connect the supplied coaxial cable between the surge protector and receiver.

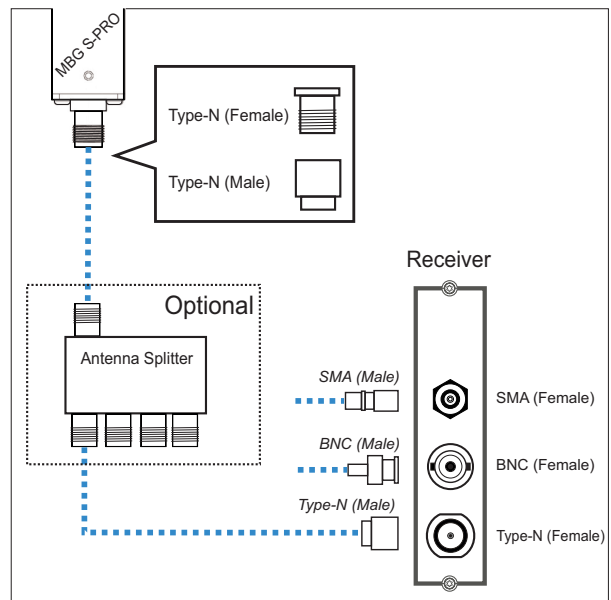

Antenna splitter option

We recommend to install an antenna distributor between antenna and receiver if the cable length exceeds 300 m. This serves on the one hand as an antenna distributor (DCF AV4) so that several receivers can be connected to one antenna and on the other hand as an amplifier of the antenna signal. The AV may be installed at any position between the surge protection (if present) and the receiver and requires a power supply of 230 V / 50 Hz.

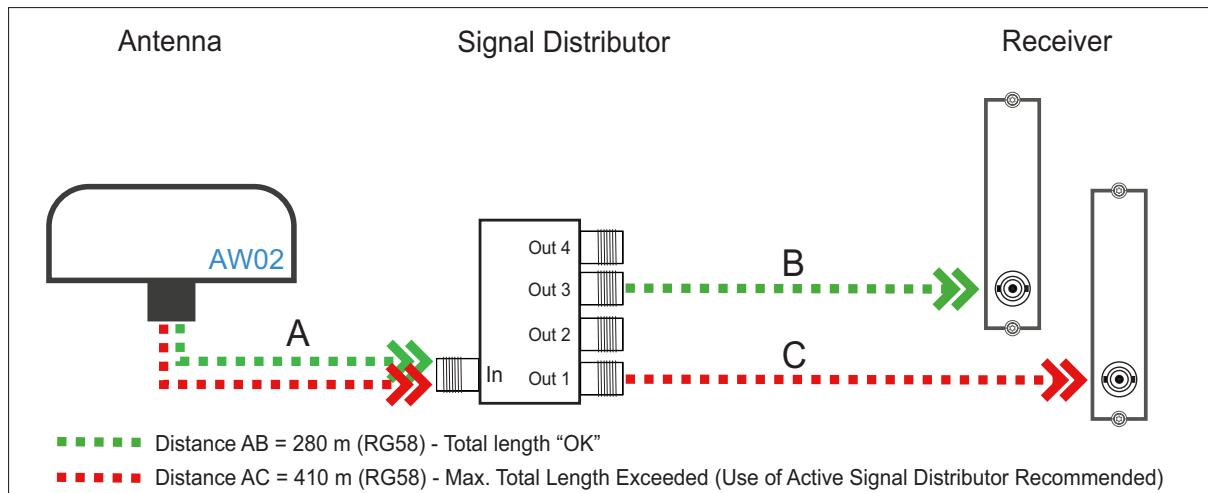

Compensation of the DCF signal delay

To ensure that the connected receiver can compensate the transmission time from transmitter mast and receiver, you must enter the distance (linear distance) from the antenna location to the transmitter mast in kilometres in the settings of your receiver.

6.2 Connecting the System

Make sure that the system to be connected is connected to your PC or the network via either a serial or a network connection and is on the same physical network.

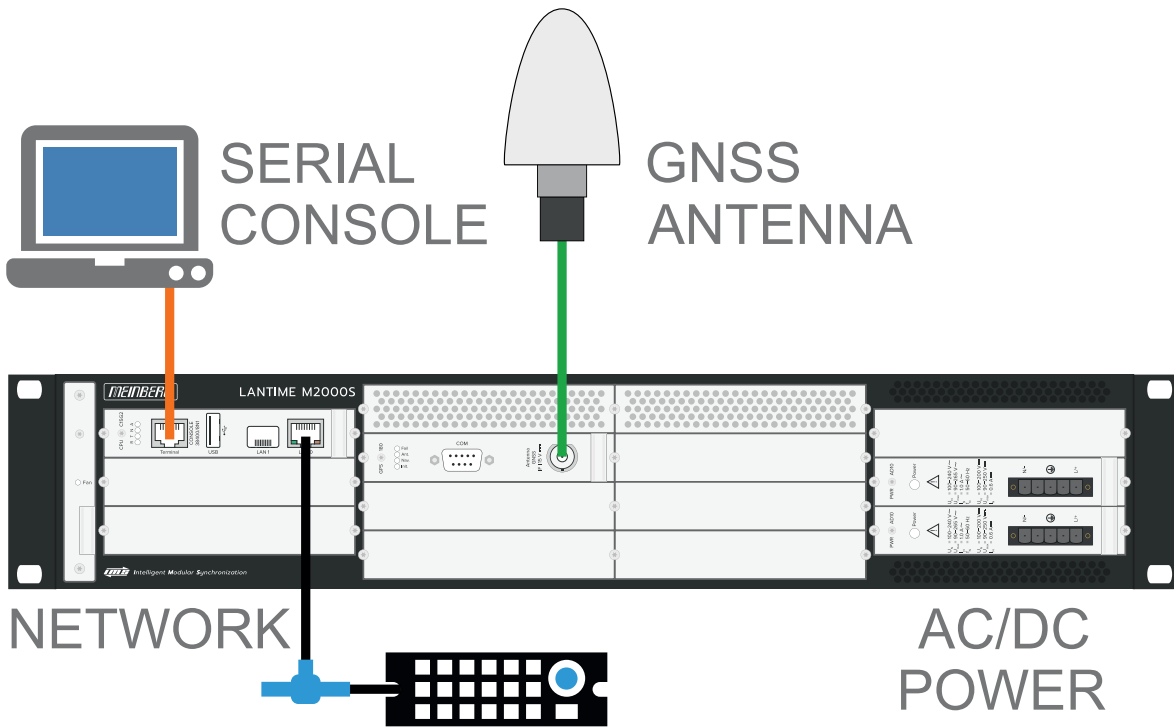

Figure: Connection scheme LANTIME M2000 with power supply, network connector, serial connection and antenna link

The following section describes how you can initially put a LANTIME system into operation via serial connection or with help of the Web Interface.

6.3 Initial Network Configuration

After the system has been connected to the power supply and to the receiver antenna, the initial start-up can be started. The device starts immediately after connection to the power supply.

An IMS LANTIME system is shipped with DHCP service enabled on the LAN 0 interface. This means that you have to establish a manual network connection if no DHCP service is installed in your network environment in order to perform system settings via the web interface.

Serial connection with *Basic Configuration Wizard* (without LC display).

After switching on the device, a terminal program (e.g. Putty) can be started after about one minute. Connect the system's serial interface (TERM/CONSOLE) with a null modem cable or a CAB-CONSOLE-RJ45 cable. The settings for the interface must be set to 38400 baud, 8 data bits, no parity and one stop bit (8N1). The terminal emulation must be set to VT100. Computers without serial interface can be connected with a "Serial-to USB" converter.

After connection is established, the prompt for the user ID should be displayed:

```
Welcome to Meinberg LANTIME
login: _
```

Default user: **root**

Default password: **timeserver**

(press RETURN again if necessary)

Change with the console to the directory `/wizard/`. The LANTIME Basic Configuration Wizard can now be started with the "startwizard" command.

After successfully starting the Wizard, the following welcome screen will be displayed:

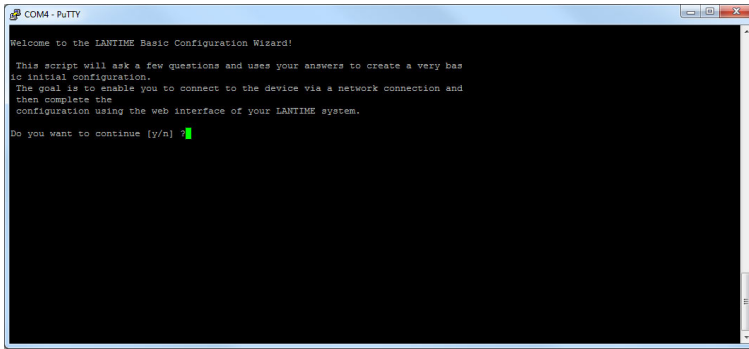

By entering "y" you start the configuration - all further settings can now be made:

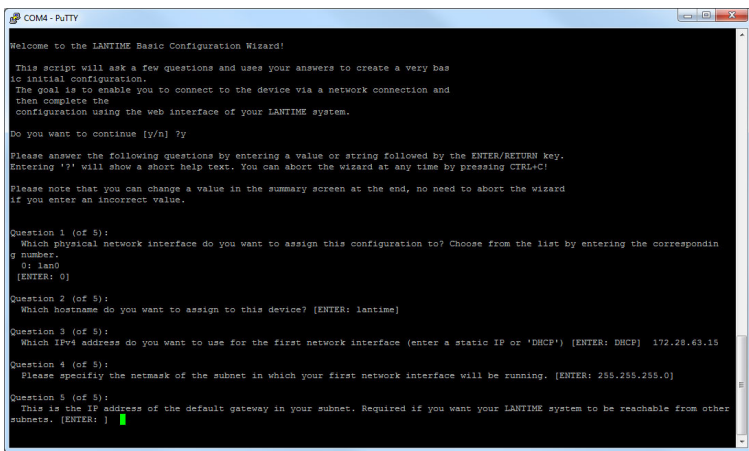

Confirm your settings then.

7 System Operation - Configuration and Monitoring

The screenshot displays the LANTIME Web Interface. At the top, there is a navigation bar with the Meinberg logo and 'LANTIME Web Interface' text. On the right, it shows system status: Reference Time, Time Service, Network, and Alarm (all green checkmarks), Active Alarms (0 Critical, 7 Error), and user information (Logged in as: root, Access-Level: Super-User, Firmware-Build). Below the navigation bar is a 'Main Menu' section with tabs for Main, Network, Notification, Security, NTP, PTP, System, Statistics, Clock, IO Config, SyncMon, Docs & Support, and Logout. The main content area is titled 'LANTIME - Main Menu' and contains two sections: 'General Information' and 'Network Information'. The footer contains contact and internet information for Meinberg Funkuhren GmbH & Co. KG.

| General Information | | Serial Number | |
|---------------------|---------------------|----------------------|--------------|
| LANTIME | M4000 IMS [GPS+GPS] | Serial Number | N/A |
| Contact | Gregoire | Serial Number LANCPU | 034811000480 |
| Uptime | 36 days 18:46 | Location | Software |

| Network Information | | Domain | |
|----------------------------|---------------------------|---------------------------|---------------------------------|
| Hostname | LT-GREG-29-105 | IPv6 (VIF 1) | Not assigned |
| LAN IPv4 (VIF 1 - bond0:0) | 172.27.29.105/16 | IPv6 (VIF 2) | Not assigned |
| LAN IPv4 (VIF 2 - bond0:1) | Not assigned | PTP IPv6 (HPS, Slot: IO2) | 2001:db8:a0b:12f0::1/64 [PTPv2] |
| PTP IPv4 (HPS, Slot: IO2) | 172.27.100.229/16 [PTPv2] | PTP IPv6 (TSU, Slot: IO4) | Not assigned |
| PTP IPv4 (TSU, Slot: IO4) | 0.0.0.0/0 [PTPv2] | | |

Meinberg Funkuhren GmbH & Co. KG
Lange Wand 9
D - 31812 Bad Pyrmont, Germany

Contact
Phone: +49 (0) 52 81 / 93 09 - 0
Fax: +49 (0) 52 81 / 93 09 - 230

Internet
Website: <https://www.meinbergglobal.com>
Email: info@meinberg.de

The LANTIME web interface.

You have access to all NTP servers of the LANTIME M series via the LANTIME web interface. To connect simply enter the set IP address of your LANTIME system into the address line of a standard web browser. A login dialog will open - in delivery state you can use the following login data:

User: *root*

Password: *timeserver*

Note: Please change these credentials during the first web session on your LANTIME.

For detailed documentation about management and monitoring please refer to the latest LTOS firmware manual at:

<http://www.mbg.link/doce-fw-ltos>

or in the menu "Documentation → Available Documents" in the web interface.

8 Maintenance, Servicing and Repairing

8.1 Firmware Updates

On our firmware download page at:

<https://www.meinbergglobal.com/english/sw/firmware.htm>

we provide the latest version of the LANTIME firmware for free download. If you need an older version, then you can request it from our support. To do so, select the option "A specified firmware version" and then enter the version of the currently used firmware and the desired firmware version (e.g. LTOS 6.24.027). For security reasons, we always recommend the latest version of the respective firmware generation (V5 / V6 / V7).

In the web interface menu "System" you can copy a new firmware version to your LANTIME under "Firmware/-Software Update". With the submenu "Configuration & Firmware Management → Firmware Management" you can easily activate different firmware versions and delete versions that are no longer needed. Existing configurations can be stored here to save them as backup. Furthermore, configurations from other LANTIMES can be transferred to the system here.

| Available Configurations | | Options | | |
|---------------------------|--|----------|--------|----------|
| startup | | Activate | Delete | Download |
| preupdate | | Activate | Delete | Download |
| lt_backup_config_N_A_greg | | Activate | Delete | Download |

| Available Firmware Files | Version | Type | Options | |
|--------------------------------|----------|---------|----------|--------|
| OSV (Original Shipped Version) | 6.25.181 | testing | Activate | Delete |
| fw_7.00.027-testing | 7.00.027 | testing | Activate | Delete |
| fw_7.00.037-testing | 7.00.037 | testing | Activate | Delete |
| fw_7.00.045-testing | 7.00.045 | testing | Activate | Delete |

9 Troubleshooting and Alarming

If there is a problem with your IMS LANTIME system, you can contact our technical support at any time. In order to perform a fast and targeted diagnosis of your system please provide us with a diagnostic file of the affected LANTIME system. You can create this diagnostic file via the web interface. For this select the menu "System → Diagnostics" and then use the button **Download Diagnostic File**. In the submenu "Configuration & Firmware Management" you can save your current configuration under **Configuration Management**. This file is also helpful for our staff when solving problems.

Configuration Management

Save Current Configuration As:

Upload Configuration:
 keine ausgewählt

| Available Configurations | Options | | |
|--------------------------|---|---------------------------------------|---|
| startup | <input type="button" value="Activate"/> | <input type="button" value="Delete"/> | <input type="button" value="Download"/> |
| preupdate | <input type="button" value="Activate"/> | <input type="button" value="Delete"/> | <input type="button" value="Download"/> |
| Conf_09-20 | <input type="button" value="Activate"/> | <input type="button" value="Delete"/> | <input type="button" value="Download"/> |

If these files are too big to send by mail, you can also use our upload page:
<https://www.meinbergglobal.com/upload/>

Please enter the serial number of your device again and, if already available, a support ticket number.

Otherwise there are a lot of tools available for self-help. Please also read the chapter Support Information.

9.1 System Error Messages

System messages and notifications.

In the web interface menu "Main" under **System Messages** and in the menu "Notification → Notification Events" you are able to view the last system notifications and the triggered event notifications. For the system messages the date and UTC time is displayed, for the notifications the date and UTC time of the last occurrence of the triggered event is displayed. In addition, the event level is also displayed for the notifications (**Info**, **Action**, **Warning**, **Error**, **Critical**).

Notification Events

| Event | Type | Status | Triggered | Triggers | | | | | | |
|----------------------|----------|--------|-----------|--------------------------|--------------------------|--------------------------|--------------------------|--------------------------|--------------------------|---|
| | | | | EMAIL | SNMP | DISP | USER | ALED | | |
| Normal Operation | Info | | | <input type="checkbox"/> | <input type="checkbox"/> | <input type="checkbox"/> | <input type="checkbox"/> | <input type="checkbox"/> | <input type="checkbox"/> | + |
| NTP Not Sync | Error | | | <input type="checkbox"/> | <input type="checkbox"/> | <input type="checkbox"/> | <input type="checkbox"/> | <input type="checkbox"/> | <input type="checkbox"/> | + |
| NTP Sync | Info | | 🔔 4d ago | <input type="checkbox"/> | <input type="checkbox"/> | <input type="checkbox"/> | <input type="checkbox"/> | <input type="checkbox"/> | <input type="checkbox"/> | + |
| NTP Stopped | Critical | | | <input type="checkbox"/> | <input type="checkbox"/> | <input type="checkbox"/> | <input type="checkbox"/> | <input type="checkbox"/> | <input type="checkbox"/> | + |
| Trusted Source OK | Info | 1 2 | | <input type="checkbox"/> | <input type="checkbox"/> | <input type="checkbox"/> | <input type="checkbox"/> | <input type="checkbox"/> | <input type="checkbox"/> | + |
| Trusted Source Error | Error | 1 2 | | <input type="checkbox"/> | <input type="checkbox"/> | <input type="checkbox"/> | <input type="checkbox"/> | <input type="checkbox"/> | <input type="checkbox"/> | + |
| | | | | + | + | + | + | + | | |

Autorepeat Event: Max. Number of Repetition:

10 Support Information

In this chapter you will learn about different levels of support at the Meinberg Company. In general, the Basic Customer Support level is included in the price you pay for your Meinberg product and demands no additional costs. It includes free e-mail, phone support and free lifetime firmware updates for the lifetime of your product, i.e. for as long as you choose to use it.

Depending on the product this level also includes a 2 or 3 year hardware warranty. You can extend the hardware warranty period after the standard warranty of your Meinberg product ends.

The chapter includes:

- Basic Customer Support
- Support Ticket System
- How to download a Diagnostic File
- Self-Help Online Tools
- NTP and IEEE 1588-PTP online tutorials
- The Meinberg Academy introduction and offerings
- Meinberg Newsletter

10.1 Basic Customer Support

Contact Meinberg via e-mail or phone.

| Technical Support | |
|-----------------------|--|
| E-Mail | techsupport@meinberg.de |
| Service hotline | +49 (0) 5281 / 9309-888 |
| Service hours hotline | Mon – Thu 8:00 – 17:00, Fri 8:00 – 16:00 (CET/CEST) Not available on Sat/Sun and German Public Holidays |

| Office (Sales/Purchase) | |
|-------------------------|---|
| E-Mail | info@meinberg.de |
| Service hotline | +49 (0) 5281 / 9309-888 |
| Service hours hotline | Mon – Thu 7:30 – 17:00, Fri 07:30 – 15:00 (CET/CEST) Not available on Sat/Sun and German Public Holidays |

MEINBERG Remote Support

In order to assist you with configuration, installation, monitoring and diagnostics of your Meinberg products, you can download a remote support software that allows Meinberg technical support to remote control your computer.

By following this link:

<https://www.meinbergglobal.com/english/support/remote.htm>

you can find all necessary information and to download the support.

LANTIME Firmware Updates

To check if an update is available for your LANTIME, please visit;

<https://www.meinbergglobal.com/english/sw/firmware.htm>

and fill out the form. Available firmware updates will be provided by e-mail (LANTIME firmware V5 or older versions) or with a direct download link (LANTIME firmware V6 or newer).

10.2 Support Ticket System

Meinberg assists you quickly and directly on questions regarding the initial setup of your devices, troubleshooting or if you want to update the hard- or software. We offer free support for the whole lifetime of your Meinberg product.

- Send a mail to techsupport@meinberg.de with a description of your issue.
- A support ticket will automatically be opened.
- Our support engineers will contact you as soon as possible.
- It is always helpful for our engineers to receive a diagnostic file when you send a ticket.
- The diagnostic file includes all status data of a LANTIME system logged since the last reboot and can be downloaded from all LANTIME timeservers. The file format of the diagnostic file is a tgz-archive. → See chapter How to download a Diagnostic File how to generate this file at your LANTIME system.

10.3 How to download a Diagnostic File

In most support cases the first action is to ask the customer to download the diagnostic file, because it is very helpful at identifying the current state of the LANTIME and finding possible errors. Therefore we recommend that you attach your Diagnostic File when sending a ticket to our support.

The diagnostic file includes all status data of a LANTIME system logged since the last reboot. It can be downloaded from all LANTIME timeservers or you can save the file on a USB stick connected to the device. The file format of the diagnostic file is a tgz-archive. The archive contains all the important configuration and logfiles.

10.3.1 Download via Web GUI

- Connect to the Web GUI by putting the IP address into the address field of the web browser.
- Open the „System“ page and the submenu "Diagnostics".
- Press the "Download Diagnostic File" button.

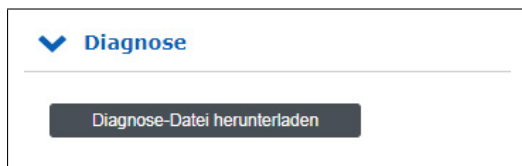

- The file will take some time to be created as its size is several MBs. After the file has been created it will be automatically sent to your web browser. Then save the file to your local hard disk.
- The diagnostic file is named "*lt_diag_SERIALNUMBER.tgz*" and the file format is a tgz archive. You can open the tgz archive e.g. with 7Zip (<https://www.7-zip.org/>).

10.3.2 Download via USB Stick

- The USB stick have to be formatted in a linux compatible file system like FAT. Connect a USB stick to the USB port of the LANTIME:
- The USB Memory Stick Menu opens automatically. Press „OK“ to confirm.
- You can use the up and down arrows to move through the menu.
- Use the „Write diagnostic File to USB stick“ option to write the current diagnostic file to the USB stick.
- You can find the Diagnostic File by opening the LANTIME folder and continue on to the Diag folder.

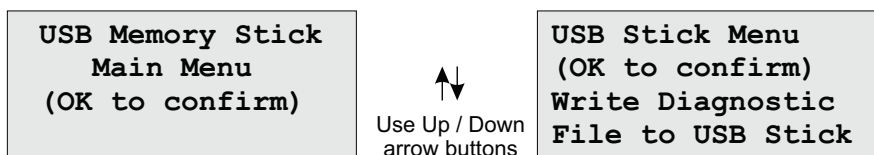

10.4 Self-Help Online Tools

Here is the list of some informative websites where you can query different information about the Meinberg Systems.

1. Meinberg Homepage - general:
<https://www.meinbergglobal.com/>
2. NTP Download - at Meinberg:
<https://www.meinbergglobal.com/english/sw/>
3. NTP Client Download for Windows (NTP-time-server-monitor):
<https://www.meinbergglobal.com/english/sw/ntp-server-monitor.htm>
4. LANTIME firmware update request online form:
<https://www.meinbergglobal.com/english/sw/firmware.htm>
5. Download page for Meinberg software, drivers and software:
<https://www.meinbergglobal.com/english/sw/>
6. All Meinberg manuals (ENG, German versions):
<https://www.meinbergglobal.com/english/docs/>
7. Meinberg Newsletter and subscription page:
<https://www.meinbergglobal.com/english/company/news.htm>
8. NTP / IEEE 1588-PTP online tutorials from Meinberg:
<http://blog.meinbergglobal.com/>
9. FAQs about Meinberg Products:
<https://www.meinbergglobal.com/english/faq/>
10. Meinberg Knowledgebase:
<https://kb.meinbergglobal.com>
11. GPS / GNSS Antenna Installation and mounting:
<https://www.meinbergglobal.com/english/info/gps-antenna-mount.htm>
<https://www.youtube.com/watch?v=ZTJMKSI8OCY> (YouTube video)
12. NTP support page and documentation:
<http://support.ntp.org/bin/view/Support/WebHome>

10.5 NTP and IEEE 1588-PTP online tutorials

A team of Meinberg engineers are writing online tutorials covering topics on IEEE 1588 PTP, NTP, synchronization setups and configurations used in different industries.

The tutorials can be found at:
<http://blog.meinbergglobal.com/>

The blog provides you also the opportunity to write a comment or a question to our experts and get their reply.

Categories:

Configuration Guidelines, IEEE 1588, Industry Applications, NTP and Security.

10.6 The Meinberg Academy introduction and offerings

Meinberg Sync Academy (MSA) is an institution within the Meinberg Company which takes care for education and expert knowledge dissemination in the field of time and frequency synchronization. The academy offers tutorials and courses on the latest synchronization technologies such as NTP, IEEE 1588-PTP, synchronization networks for different industries: telecom, power, broadcasting, professional audio/video, finance, IT and . The MSA courses include both, theoretical lectures and practical hands-on labs.

If you are planning or re-designing synchronization for your networks and you need additional knowledge, see our agenda for the upcoming courses.

Homepage: <https://www.meinbergglobal.com/english/support/meinberg-sync-academy.htm>

Courses: Meinberg Product Training, NTP Complete, PTP Complete
Customized Trainings and Online Trainings.

Contact Phone: +49 (0) 5281 93093-0

E-Mail: info@meinberg.de

10.7 Meinberg Newsletter

Meinberg publishes regularly up-to-date information, technical news, firmware updates and security advisory by the Meinberg Newsletter in both the English and German language.

Subscribe to the newsletter here:

<https://www.meinbergglobal.com/english/contact/newslett.htm>

11 Technical Appendix

11.1 Available Modules and Connectors

| Name | Type | Signal | Cable |
|--|----------------------------------|--|--|
| Front Connectors | | | |
| Terminal USB | 9pin. D-SUB male USB Port | RS-232 | shielded data line USB Stick |
| Rear Connectors | | | |
| Power supply | 5pin. DFK male | 100-240 V AC / 50-60Hz 100-200 V DC | 5pin. MSTB clamp |
| GPS Antenna or Multi GNSS Antenne | BNC SMA | 10MHz / 35.4MHz L1 Frequency band: GPS/GLONASS/Galileo/BeiDou | shielded coaxial line shielded coaxial line |
| Terminal USB Network LAN-CPU | RJ45 USB Port RJ-45 SFP | RS-232 (38400/8N1) 10/100/1000 Base-T 1000Base-T | CAB-CONSOLE-RJ45 shielded data line shielded data line |
| Module Options | | | |
| Power | | | |
| DC power supply | 5pin. DFK male | 20-60 V DC | 5pin. MSTB clamp |
| Network | | | |
| LNE-GbE | RJ45 SFP | 10/100/1000 MBit 1000BASE-T | shielded data line |
| HPS100 | RJ45/SFP | 10/100/1000 MBit | shielded data line |
| Signal Outputs: | | | |
| CPE - configurable | BNC, DFK-2, DSUB9, ST | PPOs, serial TS, TC FO ... | shielded data line |
| BPE - fixed | BNC, ST | PPS, 10MHz, TC, 2,048kHz ... | shielded data line |
| LIU: | RJ45 jack BNC | E1/T1 balanced 120 Ohm (Clock) E1/T1 unbalanced 75 Ohm (Bits) | shielded data line shielded data line |
| LNO | BNC | 10MHz sine | shielded data line |
| REL | DFK-3 | Error Relay | |

| Name | Type | Signal | Cable |
|--------------------------------|-----------|--|--------------------|
| Signal Inputs: | | | |
| ESI | BNC, RJ45 | E1/T1, var. Freq. | shielded data line |
| MRI | BNC / FST | 10MHz, PPS, IRIG, PP | shielded data line |
| VSI | BNC | Video Sync, LTC, Word Clk and PPS Input | shielded data line |
| Input / Output Modules: | | | |
| PIO | BNC | PPS, 10MHz | shielded data line |

11.2 Terminal

A serial terminal connection (for certain device models) can be established using the "CONSOLE" RJ45 connector of the LANTIME. The PC can be connected to the time server using a CAB-CONSOLE-RJ45 cable. This terminal connection can be used to perform configuration of the time server via the command line using suitable terminal software such as the HyperTerminal software shipped as standard with the Windows operating system. The terminal software on the PC should be configured to communicate at 38400 baud, 8 data bits, no parity and 1 stop bit, with terminal emulation set to VT100. Once connected to the time server, the login prompt should be displayed (you may need to press RETURN again).

(default user: root; password: timeserver).

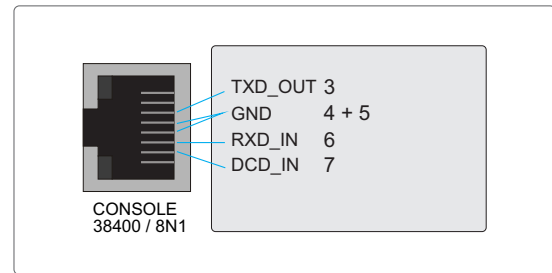

Information:

The RJ45 connector marked "CONSOLE" cannot be used to establish a connection with an Ethernet network. This interface is exclusively used to establish a direct serial connection with terminal software.

11.3 USB Port

All M-series LANTIME devices have a USB interface that allow a USB storage medium such as a flash drive to be connected. USB storage media can be used for the following tasks:

- locking the keys on the LC display to prevent unauthorized access
- backing up the LANTIME configuration
- transferring configurations between individual LANTIMES
- copying log files
- installing firmware updates
- uploading and downloading secure certificates (SSL, SSH) and passwords

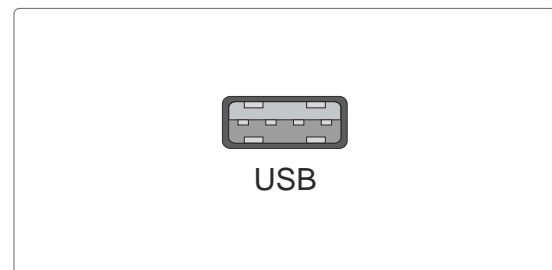

11.4 Replacement or Installation of a Hot-pluggable IMS Module

If the system is supplied with an antenna and antenna cable, it is advisable to first mount the antenna in a suitable location (see chapter Antenna Mounting) and lay the antenna cable.

Please use a Torx screwdriver (T8 x 60) for removal and installation of the module.

1. Follow the safety instructions at the beginning of this manual!
2. Remove the two marked Torx screws from the module holder plate or the cover plate of the empty slot.
3. **Note when removing!**
Pull the module carefully out of the guide rail. Note that the module is firmly anchored in the connector block of the housing. You need a certain amount of force to release the module from this link. Once the connection to the connector block of the system's backplane is loosened, the module can be easily pulled out.

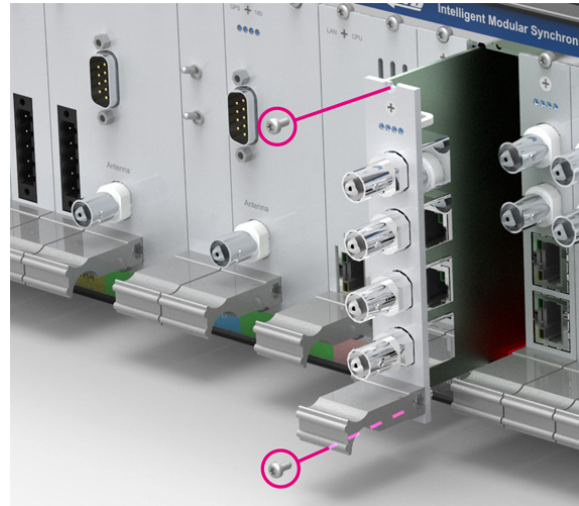

4. **Note during installation!**
Please ensure that the module is correctly inserted into the two guide rails of the system housing as otherwise damage to the module and the housing could be caused. Make sure that the module is securely locked into the connector block before you fasten the two screws.
5. Now you can put the installed module into operation.



Attachment points of an 1U IMS system

11.4.1 Important Information Regarding Hot-Pluggable IMS Modules

The following information should be strictly observed when replacing IMS modules during operation. Not all IMS modules are fully hot-pluggable. For example, it is naturally not possible to replace a power supply unit in a system without PSU redundancy without first having installed a second power supply unit while the system is in operation.

The following rules apply for the individual IMS slots:

| | | |
|--------------------------------|----------------------------|---|
| PWR Slot: | "Hot-Swappable" | If you operate your system with only one power supply unit, a second power supply unit must be installed before removing or replacing it in order to keep your system on. |
| I/O, ESI and MRI Slots: | "Hot-Pluggable". | |
| CLK1/CLK2 Slots: | "Hot-Pluggable" | When a clock module is replaced or installed, it is important to rescan the reference clocks ("Rescan Refclocks") in the "System" menu of the Web Interface. |
| RSC/SPT Slots: | "Hot-Pluggable" | It will not be possible for your IMS system to switch between signal generators while the RSC/SPT is not installed. |
| <hr/> | | |
| CPU Slot: | <u>"Not</u> Hot-Pluggable" | Before the CPU is removed, the IMS system must be powered down. Please note that after powering on and rebooting the LANTIME Operating System, the configuration of some IMS modules may be reset to factory defaults! |



Information:

The NTP service and access to the web interface will be unavailable while the CPU is not installed. Management and monitoring functions will also be disabled.

11.5 IMS Module Options

11.5.1 IMS M2000S Slot Assignment

The IMS system M2000S is available in a redundant design, which allows the use of two Meinberg receivers and up to three power supplies.



The following modules can be used in the designated slots:

- ACM** Active Cooling Module
- I/O** All output modules (BPE, CPE, LIU, LNO, SCG, VSG ...)
All network modules (LNE, TSU, HPS100 ...)
TSU and modules can only operate in PTP Grandmaster mode in an I/O slot.
HPS modules (with FW $\geq 1.4.1$) can operate in all I/O slots as PTP master or slave.
- CPU** CPU Management Module
- CLK** All available reference clocks (GPS, GNS, GNS-UC, GNM, PZF, TCR)
- ESI** ESI input module for telecom references
VSI Video synchronization inputs
All output modules and all network modules
TSU and HPS modules can operate in PTP Grandmaster and Slave mode in an ESI slot *.
- MRI** MRI standard reference input signals (PPS, 10 MHz, IRIG)
ESI input module for telecom references
VSI Video synchronization inputs
All output modules and all network modules
TSU and HPS modules can operate in PTP Grandmaster and Slave mode in a MRI slot *.
Additionally SyncE can be used as input reference in a MRI Slot.
- PWR** All available power supplies (AC/DC, DC)

* In case of a redundant receiver configuration and installation in an ESI/MRI slot, the master/slave mode only works for the assigned clock. This means that if the CLK1 receiver has to be synchronized via an HPS, then the HPS must either be installed in an IO slot or in the MRI1/ESI1 slot.

11.5.2 Power Supply 100-240 V AC / 100-200 V DC

Connector Type: 5-pol. DFK

Pin Assignment:

- 1: N/-
- 2: not connected
- 3: PE (Protective Earth)
- 4: not connected
- 5: L/+

Input Parameter

| | | | |
|--------------------------|-----------|---|--------------------------|
| Nominal Voltage Range: | U_N | = | 100-240 V~ 100-200 V= |
| Maximum Voltage Range: | U_N | = | 90-265 V~ 90-250 V= |
| Nominal Current: | I_N | = | 1.0 A ~ 0.6 A = |
| Nominal Frequency Range: | f_N | = | 50-60Hz |
| Maximum Frequency Range: | f_{max} | = | 47-63Hz |

Output Parameter

| | | | |
|-------------------------|-------------|---|----------------------------|
| Maximum Power: | P_{max} | = | 50 W |
| Maximum thermal energy: | E_{therm} | = | 180.00 kJ/h (170.61 BTU/h) |

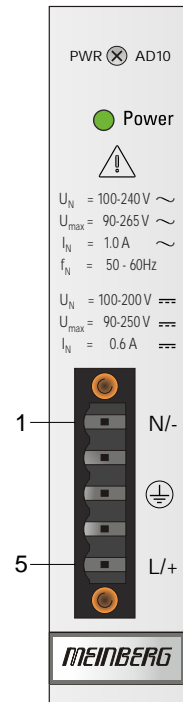

Danger!

This equipment is operated at a hazardous voltage.

Danger of death from electric shock!



- This device must be connected by qualified personnel (electricians) only.
- Never handle exposed terminals or plugs while the power is on.
- All connectors must provide protection against contact with live parts in the form of a suitable plug body!
- Always ensure that wiring is safe!
- The device must be grounded by means of a connection with a correctly installed protective earth conductor (PE).

11.5.3 Power Supply 20-60 V DC

Connector: 5pin DFK

Pin Assignment:

| | |
|----|-----------------------|
| 1: | not connected |
| 2: | V_{IN-} |
| 3: | PE (Protective Earth) |
| 4: | V_{IN+} |
| 5: | not connected |

Input Parameter

Nominal voltage range: $U_N = 24-48 \text{ V} \text{ ---}$

Maximum voltage range: $U_{max} = 20-60 \text{ V} \text{ ---}$

Nominal current: $I_N = 2.1 \text{ A}$

Output Parameter

Maximum power: $P_{max} = 50 \text{ W}$

Maximum thermal energy: $E_{therm} = 180.00 \text{ kJ/h (170.61 BTU/h)}$

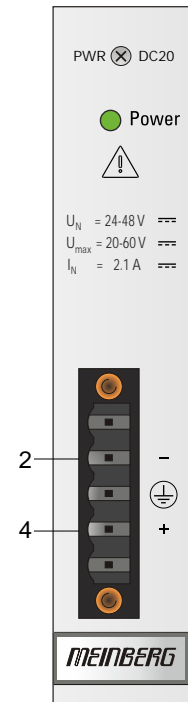

11.5.4 Power Supply 10-36 V DC

Connector: 5pin DFK

Pin Assignment:

| | |
|----|-----------------------|
| 1: | not connected |
| 2: | $V_{IN} -$ |
| 3: | PE (Protective Earth) |
| 4: | $V_{IN} +$ |
| 5: | not connected |

Input Parameter

Nominal voltage: $U_N = 24\text{ V} \text{ ---}$

Maximum voltage range: $U_{max} = 10\text{-}36\text{ V} \text{ ---}$

Nominal current: $I_N = 2.5\text{ A}$

Output Parameter

Maximum power: $P_{max} = 50\text{ W}$

Maximum thermal energy: $E_{therm} = 180.00\text{ kJ/h (170.61 BTU/h)}$

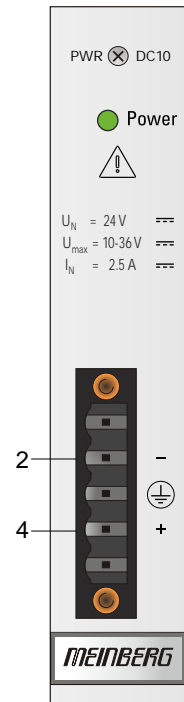

11.5.5 IMS Receiver Modules

The following receiver modules are available for our IMS systems:

GNSS satellite receivers

| | |
|---------------------|--|
| IMS-GPS receiver | 12 channel GPS C/A-code receiver |
| IMS-GNS receiver | 72 channel GPS/GLONASS/Galileo/BeiDou receiver (also for mobile applications) |
| IMS-GNS-UC receiver | 72 channel GPS/Galileo receiver (with Meinberg antenna/converter unit) |
| IMS-GNM receiver | 72 channel GPS/GLONASS/Galileo/BeiDou multiband receiver (simultaneous reception of all GNSS systems) |

Long wave receiver (DCF77)

| | |
|------------------|---------------------------------|
| IMS-PZF receiver | high accuracy DCF77 based clock |
|------------------|---------------------------------|

Time code reader and generator (IRIG, AFNOR ...)

| | |
|------------------|---------------------------------------|
| IMS-TCR receiver | decoding and generation of time codes |
|------------------|---------------------------------------|

The following oscillator options are available for all receiver types:

- OCXO-SQ
- OCXO-MQ
- OCXO-HQ
- OCXO-DHQ (not for redundant M1000 configurations)

In addition to the redundant receiver configurations with two identical receivers for M1000, M2000, M3000, and M4000 models, it is also possible to configure these housing types with two different receiver systems.

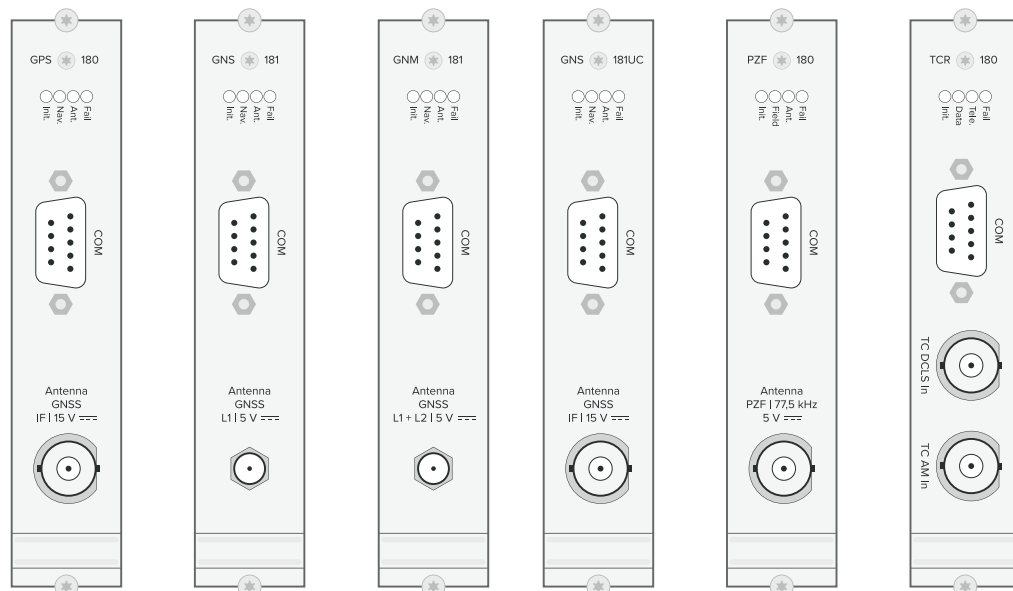

Pin Assignment of the DSUB9 Connectors (male):

- Pin 2: RxD
- Pin 3: TxD
- Pin 5: GND

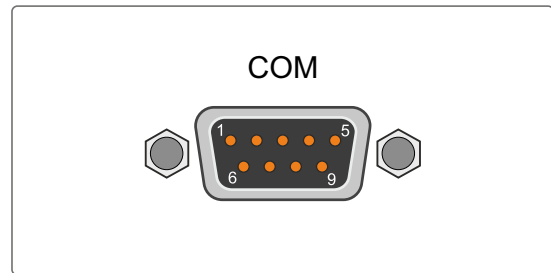

Synchronization with PPS + string:

Our IMS receivers are all MRS-capable (Multi Reference Source), which means that they can be synchronized via external sources such as 10 MHz, PPS + time string, NTP, PTP, 2048 kHz etc.. For synchronization via PPS + String no additional input module (MRS, ESI, HPS) has to be selected - the input signal and the time string can be supplied via the 9-pin DSUB connector. The connector has the following pin assignment:

Pin 1: PPS

- Signal level: TTL
- Pulse length: $\geq 5 \mu s$ (active high)

Pin 2: String

The following timestrings (time telegrams) can be used:

- NMEA RMC
- NMEA ZDA
- Meinberg Standard
- Uni Erlangen

Please note:

The ext. time string must not arrive later than 500 msec. than the PPS. If the offset is greater than 500 msec, the time string is discarded and not recognized. For synchronization of the clock the information about time and date is missing.

Pin Assignment of the optional XHE-SPI Connectors:

- A1: PPS In
- A2: PPS Out

- Pin 1: SCL_Out (SPI Clock)
- Pin 2: CS (Chip Select)
- Pin 3: MOSI (Master Out, Slave In)
- Pin 4: MISO (Master In, Slave Out)
- Pin 5: GND

Attention: Use this plug only to connect a MEINBERG IMS-XHE^{Rb} Rubidium expansion chassis. The XHE-SPI connector is only available for Meinberg GNS receivers (GPS, GNS, GNS-UC, GNM).

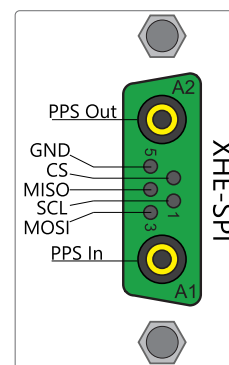

11.5.5.1 GPS Clock

| | |
|---|--|
| Receiver: | 12 channel GPS C/A-code receiver |
| Accuracy of pulse outputs: | Depends on oscillator option: < +-100 ns (TCXO, OCXO LQ) < +-50 ns (OCXO-SQ, -MQ, -HQ, -DHQ) |
| Antenna Cable: | shielded coax |
| Cable Length: | max. 300 m to RG58, max. 700 m to RG213 |
| Antenna Connector: | BNC female |
| Input GPS: | Antenna circuit 1000 V DC insulated |
| Local Oscillator to Converter Frequency: | 10 MHz ¹ |
| First IF Frequency: | 35.4 MHz ¹ |
| | 1) these frequencys are transferred via the antenna cable. |
| Antenna Power Supply: | 15 V, 100 mA (via antenna cable) |
| Figure right: | GPS receiver and GPS with XHE-SPI connector (option) |

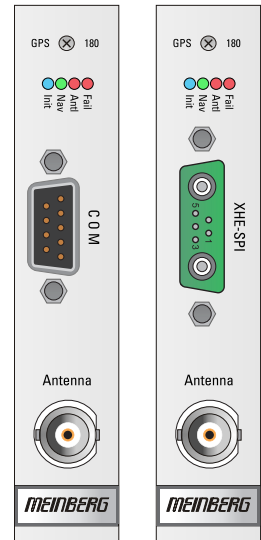

LED Indicators

| | | |
|-------|---------|--|
| Init: | blue: | while the receiver passes through the initialization phase |
| | green: | the oscillator has warmed up |
| Nav.: | green: | positioning successfully |
| Ant: | red: | antenna faulty or not connected |
| | yellow: | the clock is synchronized by an external Signal - MRS mode (PPS, IRIG ...) |
| Fail: | red: | time has not synchronized |

11.5.5.2 GNSS Clock

Type of receiver: GPS / GLONASS / Galileo / Beidou receiver
 Number of channels: 72
 Frequency band: GNSS L1
 1575.42 +- 10 MHz / 1602-1615 MHz

Accuracy of Pulses: Dependant on oscillator option
 < +-100 nsec (TCXO, OCXO-LQ)
 < +-50 ns (OCXO-SQ, -MQ, -HQ, -DHQ)

Synchronization Time: Max. 1 minute in normal operation mode,
 approx. 12 minutes after a cold start

Antenna Cable: shielded coax cable (Belden H155 PE)

Cable Length: max. 70 m low-loss cable

Type of Connector: female SMA connector

Antenna Power Supply: 5 V DC (via antenna cable)

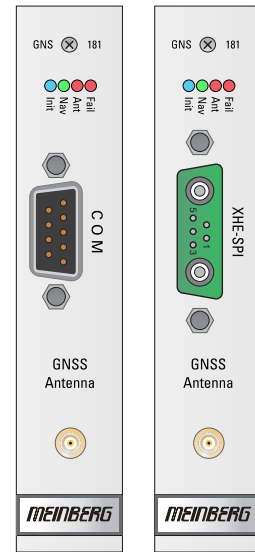

LED Indicators

| | | |
|-------------|---------|--|
| Init | blue: | while the receiver passes through the initialization phase |
| | green: | the oscillator has warmed up |
| Nav. | green: | positioning successfully |
| Ant | red: | antenna faulty or not connected |
| | yellow: | the clock is synchronized by an external Signal - MRS mode (PPS, IRIG ...) |
| Fail | red: | time has not synchronized |

11.5.5.3 GNS-UC Clock

GNSS receiver with UpConverter for operation on a standard Meinberg GPS antenna/converter unit.

| | |
|------------------------------|---|
| Type of receiver: | GPS / Galileo receiver Number of channels: 72 GPS: L1C/A Galileo: E1B/C |
| Accuracy of Pulses: | Dependant on oscillator option < +-100 nsec (TCXO, OCXO-LQ) < +-50 ns (OCXO-SQ, -MQ, -HQ, -DHQ) |
| Synchronization Time: | Max. 1 minute in normal operation mode, approx. 12 minutes after a cold start |
| Antenna Cable: | shielded coax cable |
| Cable Length: | max. 300 m |
| Type of Connector: | female BNC connector |
| Antenna Power Supply: | 15 V, 100 mA (via antenna cable) |

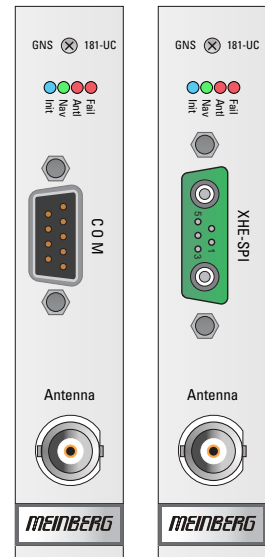

LED Indicators

| | | |
|-------------|---------|--|
| Init | blue: | while the receiver passes through the initialization phase |
| | green: | the oscillator has warmed up |
| Nav. | green: | positioning successfully |
| Ant | red: | antenna faulty or not connected |
| | yellow: | the clock is synchronized by an external Signal - MRS mode (PPS, IRIG ...) |
| Fail | red: | time has not synchronized |

11.5.5.4 GNM Clock

Receiver Type 184-channel
GPS, GLONASS, Galileo, Beidou

Frequency Band:

GPS:
L1C/A (1575.42 MHz)
L2C (1227.60 MHz)

GLONASS:
L1OF (1602 MHz + $k \cdot 562.5$ kHz)
L2OF (1246 MHz + $k \cdot 437.5$ kHz)
 $k = -7, \dots, 5, 6$

Galileo:
E1-B/C (1575.42 MHz)
E5b (1207.140 MHz)

Beidou:
B1I (1561.098 MHz) B2I (1207.140 MHz)

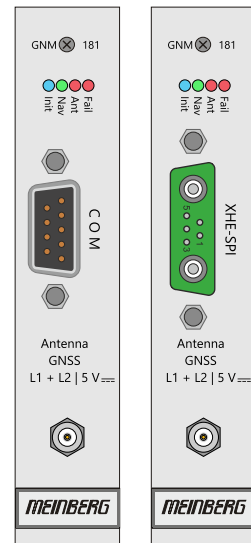

Accuracy of Pulses: Dependant on oscillator option:
< +-100 ns (TCXO, OCXO LQ)
< +-50 ns (OCXO-SQ, -MQ, -HQ, -DHQ)

Synchronization Time: <1 minute in normal operation mode,
approx. 1 minutes after a cold start
(12 minutes in GPS only mode)

Signal Gain 40 dB

Antenna Gain: ≥ 3.5 dBic / ≥ 3 dBic

Connection Type: SMA female / Antenna

Cable: shielded coaxial line (Belden H155)
Cable lenght: deductible up to max. 70 m

Antenna Power Supply: 5 V DC (via antenna cable)

Nominal Impedance: 50 Ohm

Backup Battery Type: CR2032 – button cell lithium battery.
The hardware clock and the RAM are battery buffered. When the main power supply fails, the hardware clock runs free on quartz basis and the almanac data is stored in the RAM.
Life time of lithium battery: min. 10 years

Figure right: GNM Multiband receiver and
GNM with XHE-SPI connector (optional)

LED Indicators

| | | |
|-------------|---------|--|
| Init | blue: | while the receiver passes through the initialization phase |
| | green: | the oscillator has warmed up |
| Nav. | green: | positioning successfully |
| Ant | red: | antenna faulty or not connected |
| | yellow: | the clock is synchronized by an external Signal - MRS mode (PPS, IRIG ...) |
| Fail | red: | time has not synchronized |

11.5.5.5 PZF Clock

- Receiver:** High accuracy DCF77 correlation receiver
Two separate receiver channels for signal conversion and best acquisition and tracking of the DCF77 signal (AM + PZF).
- Synchronization Time:** 2-3 minutes after correct DCF77 signal reception
- Frequency Outputs:** Accuracy depends on oscillator
(standard: OCXO-SQ)
- Pulse Outputs:** Pulse per second (PPS) and pulse per minute (PPM).
TTL level, pulse width: 200 msec
- Accuracy of pulses:** Better than $\pm 50\mu\text{sec}$ after synchronization and 20 minutes of operation.
- Backup Battery Type:** CR2032 - button cell lithium battery
When main power supply fails, hardware clock runs free on quartz basis, almanac data is stored in RAM
Life time of lithium battery min. 10 years
- Oscillator Options:** OCXO-SQ, OCXO-MQ, OCXO-HQ, OCXO-DHQ
- Antenna Connector:** BNC female
- Antenna Cable:** shielded Coax cable
- Cable Length:** 300 m with standard coax cable
- Antenna Power Supply:** 5 V DC (via antenna cable)

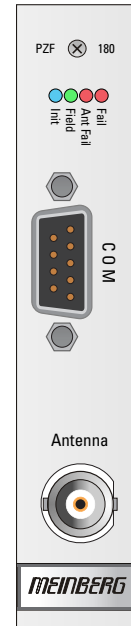

LED Indicators

- Init: blue: while the receiver passes through the initialization phase
- Field: green: minimum field strength needed for the correlation reception is detected
- Ant Fail: red: antenna faulty or not connected
- Fail: red: time is not synchronized

11.5.5.6 TCR Clock - Time Code Reader and Generator

The IMS - TCR180 serves to decode and generate modulated (AM) and unmodulated (DC Level Shift) IRIG-A/B/G, AFNOR, C37.118 or IEEE1344 time codes. AM-codes are transmitted by modulating the amplitude of a sine wave carrier, unmodulated codes by variation of the width of pulses.

As standard the clock module TCR180 is equipped with a OCXO-SQ (Oven Controlled Xtal Oscillator) as master oscillator to provide a high accuracy in holdover mode of $\pm 1E-8$. Optionally an OCXO-MQ or OCXO-HQ is available for better accuracy.

Receiver:

Automatic gain control within the receive circuit for modulated codes allows decoding of IRIG-A/B/G, AFNOR, C37.118 or IEEE1344 signals with a carrier amplitude of 600 mV_{pp} to 8 V_{pp} . The input stage is electrically insulated and has an impedance of either 50Ω , 600Ω or $5 \text{ k}\Omega$, selectable by a jumper.

DC Level Shift Input insulated by optocoupler with internal series resistance of 220Ω .



LED Indicators

| | | |
|-------------|--------------------------|--|
| Init | blue: | while the receiver passes the initialization phase |
| | off: | Oscillator not warmed up |
| | green: | the internal timing of the TCR180 is synchronized to the received time code (Lock) |
| Data | green: | correct time code detected |
| | red: | no correct time code detected |
| | yellow: | TCR180 synchronized by external source (MRS) |
| | yellow/green (flashing): | Holdover mode (MRS), IRIG Code available |
| | yellow/red (flashing): | Holdover mode (MRS), IRIG Code not available |
| Tele | green: | telegramm consistent |
| | red: | telegramm inconsistent |
| | yellow (flashing): | Jitter too large |
| Fail | red: | the internal timing of the TCR180 is in holdover mode |
| | off: | the internal timing of the TCR180 is synchronized to the received time code (Lock) |

Generator:

The generator of TCR180 is capable of producing time codes in IRIG-A/B/G, AFNOR, C37.118 or IEEE1344 format. The codes are available as modulated ($3 V_{pp} / 1 V_{pp}$ into 50Ω) and unmodulated (DC Level Shift) signals (TTL into 50Ω and RS-422).

Regarding time code and its offset to UTC, the receiver and the generator can be configured independantly. Thus TCR180 can be used for code conversion.

Key Features

- IRIG Generator
- 4 programmable Pulse Outputs
- Frequency Synthesizer
- Battery Type CR2032

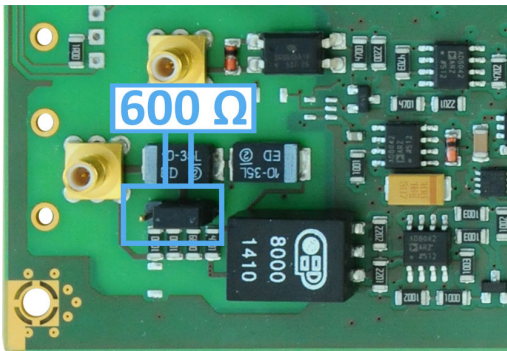

Figure 1: Jumper Settings: 600 Ω

Technical Specifications

Receiver Input

AM-input (BNC-connector): insulated by a transformer
 impedance settable 50 Ω, 600 Ω, 5 kΩ
 600 mV_{PP} to 8 V_{PP} (Mark)

Input Signal

DC Level Shift input: insulated by photocoupler
 internal series resistance: 220 Ω
 maximum forward current: 60 mA
 diode forward voltage: 1.0 V...1.3 V

Decoding

Decoding of the following telegrams possible:

IRIG-A132 / A133 / A002 / A003
 IRIG-B123 / B122 / B126 / B127 / B002 / B003 / B006 / B007
 IRIG-G142 / G146 / G002 / G006
 AFNOR NFS 87-500
 C37.118
 IEEE1344

Accuracy of Time Base

Required Accuracy of Time Code Source: max 100 μsec Jitter / offset 1E-5

Holdover Mode

Automatic switching
to crystal time base

accuracy approximately $1E-8$
if decoder has been synchronous for more than 1h

Backup Battery

If the power supply fails, an onboard realtime clock keeps time and date information important system parameters are stored in the RAM of the system lifetime of the Lithium battery at least 10 years

Generator Outputs

Modulated output:

unbalanced sine carrier, 1 kHz
 $3 V_{PP}$ (MARK), $1 V_{PP}$ (SPACE) into 50Ω

unmodulated outputs(DCLS):
TTL into 50Ω , RS-422

Pulse Outputs

Four programmable outputs, TTL level
Default settings: active only 'if sync'

PPO_0 - PPO_3:

Idle (not active)
Timer
Single Shot
Pulse Per Second, Per Minute, Per Hour (PPS, PPM, PPH)
DCF77 Marks
Time Sync
DCLS Time Code
Synthesizer Frequency

Accuracy of Pulses

Better than $\pm 1 \mu\text{sec}$ after synchronization and 20 minutes of operation

Serial Port

Configurable RS-232 interface

Baudrates: 300 Bd...115200 Bd
Framing: 7E2, 8N1, 8N2, 8E1, 7N2, 7E1, 801
Mode of operation: string per second
string per minute
string on request

Time telegram:

Meinberg Standard, Uni Erlangen, SAT, Meinberg Capture,
ION, Computime, SPA, RACAL

Capture Inputs

Triggered by falling TTL slope

Pulse repetition time: 1.5 msec min.
Resolution: 800 nsec

Master Oscillator

OCXO-SQ (Oven Controlled Oscillator)

Accuracy compared to
IRIG-reference:

sync. and 20 min. of operation: $\pm 5E-9$
first 20 min. after sync.: $\pm 1E-8$

accuracy of oscillator:
holdover, 1 day: $\pm 1E-7$
holdover, 1 year: $\pm 1E-6$

short term stability:
 ≤ 10 sec, synchronized: $\pm 2E-9$
 ≤ 10 sec, holdover: $\pm 5E-9$

temperature dependant drift:
holdover: $\pm 1E-6$

Frequency Synthesizer

Output frequency:

fixed - 2.048MHz

Accuracy:

1/8 Hz to 10 kHz:

10 kHz to 10 MHz:

like system accuracy
Phase synchronous to pulse per second
deviation of frequency < 0.0047 Hz

Synthesizer Outputs:

TTL into 50Ω
sine wave 1.5 Vrms
output impedance 200Ω

Pulse Outputs

Pulse per second (PPS):

TTL- and RS-232 level
positive pulse, pulse duration 200 msec

Pulse per minute (PPM):

TTL level
positive pulse, pulse duration 200 msec

11.5.6 RSC Switch Card

Theory of operation

The RSC- Redundant Switch Control card controls the switchover of the reference clock in redundant systems with two receiver units. The RSC is used to switchover the pulse and frequency outputs and the serial interfaces between the available receivers.

The selection of the reference is done by an internal switch-logic of the RSC. The selection of the active system based on the TIME_SYNC signals which are generated by the receivers. The TIME_SYNC signals are indicate the synchronization of the clocks.

To avoid unnecessary changeovers in case of repeatedly occurring free run operations of one system, the master/backup order is changed with each changeover. For example, let's suppose the current master system loses its synchronization. Then a changeover is performed to a synchronous slave system and thus the former slave system becomes a new Master. No changeover is done if both systems are asynchronous. In this case the current state stays the same.

Important: To ensure an automatic switchover the Manual function should be disabled via display-menu. "Ref. Time → Switch Unit": *Select Switch Unit → SCU Cntl → MANUAL: disable*. Otherwise, the system depends on the clock selected by the manual control function and the unit will not switch over to the current active clock.

Manual Mode (Display Menu)

In this operation mode the selection of the reference clock is done by a display menu. A switchover of the reference clock in case of an error does not happen, pulse and frequency outputs and the serial interfaces are always enabled.

Display Menu: *Switch Unit → SCU Cntl → MANUAL : enable*

Note:

For systems without display (M1000S, M2000S and M3000S) a LANTIME Display Unit (LDU) can optionally be used.

Display menu "Switch Unit → SCU State"

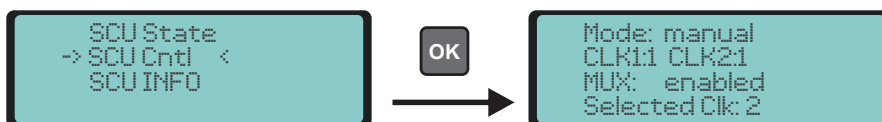

This menu displays the status information of the RSC:

Mode: manual | automatic
 Clock 1 / Clock 2: State of receivers
 MUX: enabled | disabled output signals during a free run
 Selected Clk: selected reference clock 1 or 2

Menu "Switch Unit → SCU Cntl"

```

SCU State
-> SCU Cntl <
SCU INFO
    
```

OK →

```

-> MANUAL: disabl <-
Selected Clk:2
    
```

OK →

```

SCU Outputs:
* enabled
* disabled
    
```

| | | |
|---------------|----------------|--|
| MANUAL: | enable/disable | switching between automatic and manual operation |
| Selected Clk: | 1/2 | selection of the active reference clock |

11.5.7 LAN-CPU

As the central management and control element, the CPU module in an LANTIME system is responsible for management, configuration and alarm notifications. It additionally provides NTP and SNTP services on its network interface.

Technical specifications IMS LAN CPU C05F1

| | |
|---------------------------|---|
| Processor: | AMD Geode™ LX 800 Processor, 400 MT/s memory bus speed |
| Main Memory: | 256 MByte onboard DDR memory |
| Cache Memory: | 128 kByte L2 Cache |
| Flashdisk: | 1 GB |
| Network Connector: | IEEE 802.3u 100Base-Tx via RJ45 jack, Fast Ethernet compatible |
| Power Consumption: | Typ. application 6,9 W @ 5V |

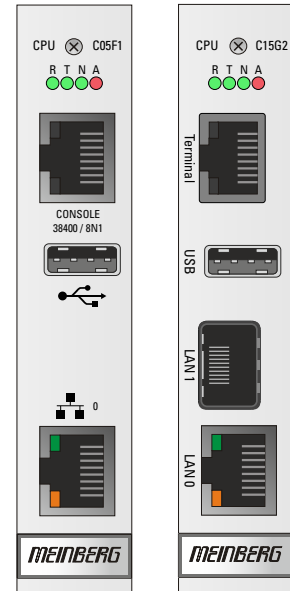

Technical Specifications - IMS CPU-C15G2 (LTOS V7 only)

| | |
|----------------------------|---|
| Processor: | Intel® Atom™ Processor E Series (2 Cores, 1.33GHz, TDP 3W) |
| Main Memory: | onboard 2 GB |
| Cache Memory: | 1 MB 2nd Level Cache |
| Flash Disk: | 4 GB |
| Network Connectors: | 1 x 10/100/1000 Base-T with RJ45-Jack 1 x 1000Base-T with SFP-Jack |
| Power Consumption: | Typ. application 6,9 W @ 5V |

Interfaces - IMS LAN-CPU

| | |
|--------------------------|---|
| Serial Interface: | RJ45 connector console: 38400 / 8N1, connection via CAB-CONSOLE cable |
| USB Port: | install firmware upgrades backup and restore configuration files copy security keys lock / unlock front keys |
| Operating System: | GNU/Linux 4.x |

Status LEDs:

LAN 0

LED - Connect, Activity and Speed of the network connection

R (Receiver)

green: the reference clock (e.g. build-in)
provides a valid time

red: the reference clock does not provide
a valid time

T (Time Service)

green: NTP is synchronized to the
reference clock, e.g.

red: NTP is not synchronized or
switched to the "local clock"

N (Network)

green: all monitored network interfaces
are connected ("Link up")

red: at least one of the monitored
network interfaces is faulty

A (Alarm)

off: no error

red: general error

Supported Protocols:

Network Time Protocol (NTP): NTP v2 (RFC 1119), NTP v3 (RFC 1305), NTP v4 (RFC 5905)
SNTP v3 (RFC 1769), SNTP v4 (RFC 4330)

OSI Layer 2 (Data Link Layer): PRP (IEC 62439-3)

OSI Layer 3 (Network Layer): IPv4, IPv6

OSI Layer 4 (Transport Layer): TCP, UDP, TIME (RFC 868),
DAYTIME (RFC 867), SYSLOG

OSI Layer 7 (Application Layer): HTTP / HTTPS (RC 2616), DHCP,
FTP, NTPv3 / NTPv4, SNTP,
RADIUS, TACACS, FTP,
SSH (incl. SFTP, SCP) - SSH v1.3 /
SSH v1.5 / SSH v2 (OpenSSH),
SNMPv1 (RFC 1157) /
SNMPv2c (RFC 1901-1908) /
SNMP v3 (RFC 3411-3418),
Telnet (RFC 854-RFC 861)

11.5.8 MRI - Standard Reference Input Signals

If an application requires to use external synchronization sources instead of radio/GNSS signals, an MRI card enables the installed clock module to synchronize to 1PPS, 10 MHz, DCLS and AM time codes (IRIG B, AFNOR, IEEE1344 or C37.118).

Each MRI card is dedicated to one clock module, if a redundant solution requires external synchronization inputs for both clock modules, two MRI cards have to be installed. The MRI card is available with 4x BNC connectors.

Reference Inputs:

Time Code unmodulated input (DCLS)

BNC connector, isolated by opto-coupler

Insulation voltage: 3750 Vrms

Internal series resistor: 330 Ohm

Max. input current: 25 mA

Diode forward voltage: 1.0 V - 1.3 V

selectable Time Code Inputs, modulated / unmodulated (DCLS):

B122/123 / B002/003 / B126/127 / B006/007

IEEE1344 (modulated and DCLS)

AFNOR NFS 87-500 (modulated and DCLS)

Time Code modulated input (AM),

BNC connector, isolated by transformer

Insulation voltage: 3000 V DC

Input impedance: 50 Ohm, 600 Ohm, 5 kOhm

Internally selectable by jumper
(default 600 Ohm)

Input signal: 600 mV to 8 V (Mark, peak-to-peak)

10 MHz input, sine ($1.5 V_{pp} - 5 V_{pp}$)

or TTL, female BNC connector

PPS input, TTL, pulse length $\geq 5\mu s$,

active high, female BNC connector

Figure right:

*MRI - standard input signals
via BNC female connectors*

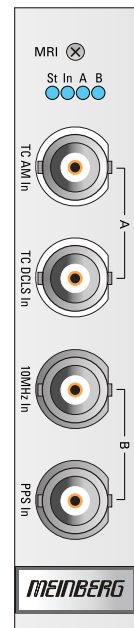

Status Indicators

| | |
|---------------------|---|
| LED St: | MRI status |
| LED In: | Status of the backplane's reference signals |
| LED A: | Status of the input signals (TC-AM/DCLS) at the board |
| LED B: | Status of the input signals (10 MHz/PPS) at the board |
| Initialisation: | LED St: blue until USB is configured LED In - LED B: off until USB is configured |
| USB is configured: | LED St: blue LED In - LED B: 0,5 sec. red -> 0,5 sec. yellow -> 0,5 sec. green -> 0,5 sec. off |
| Normal Operation: | LED St + LED In: green LED A: green, if timecode AM or timecode DCLS or both signals are available at the same time LED B: green, if 10 MHz or PPS or both signals are available at the same time |
| Power Requirements: | 5 V +-5%, 50 mA |

11.5.8.1 Configuration of Input Signals

Four fixed input signals (time code AM, time code DCLS, 10 MHz and PPS) can be supplied via the MRI module to synchronize the system.

MRS prioritization

The provided input signals are available for selection after initialization of the module and can then be configured and monitored.

The screenshot shows the 'Status & Configuration' page for the 'GPS Clock [CLK1 - Sync to GPS]'. The 'MRS-Settings' tab is active, with sub-tabs for 'Initialize Receiver' and 'XHE-Rubidium'. Below the tabs is the 'Source Priority' section, which lists eight sources in descending order of priority:

- 1. Source: GPS
- 2. Source: PPS in
- 3. Source: IRIG
- 4. Source: Fixed Freq. in
- 5. Source: PTP (IEEE1588)
- 6. Source: PPS plus string
- 7. Source: --- Unconfigured ---
- 8. Source: --- Unconfigured ---

MRS setting: selection and prioritization of the available input sources.

1. Open the "Clock" menu → "Status & Configuration"
2. Select the respective clock module of the corresponding MRI module
3. Click on the tab "MRS settings".
4. Configure the reference signals shown in the priority list.

IRIG settings

Several time codes are available for selection for the IRIG reference signals of the MRI.

1. Open the "Clock" menu → "Status & Configuration"
2. Select the respective clock module of the corresponding MRI module
3. Click on the tab "IRIG settings".
4. Configure a required input code and if necessary an offset to UTC.

These are to be configured in the "Status & Configuration" submenu in the "IRIG Settings" tab.

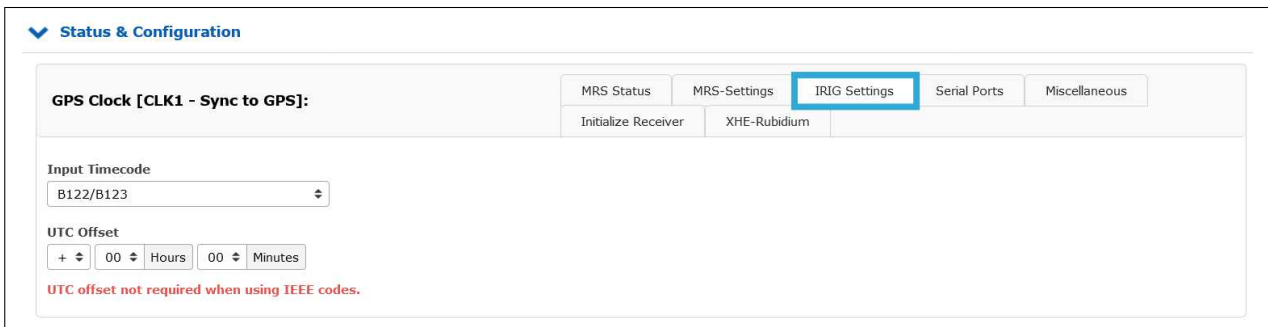

▼ Status & Configuration

GPS Clock [CLK1 - Sync to GPS]:

MRS Status MRS-Settings **IRIG Settings** Serial Ports Miscellaneous

Initialize Receiver XHE-Rubidium

Input Timecode
B122/B123

UTC Offset
+ 00 Hours 00 Minutes

UTC offset not required when using IEEE codes.

Menü: Configuration of IRIG-Timecodes

11.5.9 ESI - Telecom Synchronisation References

Enhanced Synchronisation Inputs

| | |
|--------------------------|--|
| Reference Inputs: | PPS and variable frequencies unframed, 1 kHz - 20 MHz 2,048 Mbit/s / 1,544 Mbit/s - E1/T1 framed |
| Input 1 | 1PPS (BNC female connector) TTL, pulse duration $\geq 5\mu\text{s}$, active high |
| Input 2 | 1 kHz - 20 MHz (BNC female connector) sine (400 mV _{pp} - 5 V _{pp}) or TTL |
| Input 3 | 1 kHz - 20 MHz (RJ-45) 400 mV _{pp} - 5 V _{pp} into 120 Ω , TTL |
| Input 4 | E1 or T1 framed G.703 (RJ-45) max. attenuation -12 dB (referred to the signal level) into 120 Ω |

Power Requirements: 5 V, +5%, 250 mA

Status Indicators

| | |
|----------------|--|
| LED St: | ESI status |
| LED In: | Status of the backplane's reference signals |
| LED A | Status of the input signals (1 & 2) at the board |
| LED B: | Status of the input signals (1 & 2) at the board |

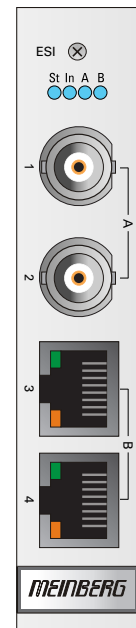

Operation conditions:

| | | |
|-------------------|-----------------|---|
| Initialisation: | LED St | blue until configuration is done |
| | LED In | off until configuration is done |
| | LED A | off until configuration is done |
| | LED B | off until configuration is done |
| expiration LEDs: | ALL LEDs | 0,5 sec. red → 0,5 sec. yellow → 0,5 sec. green → 0,5 sec. off |
| Normal Operation: | LED St | green |
| | LED In | green |
| | LED A | green, if PPS and Frequency flashing green, if only Frequency flashing yellow, if only PPS off, if no signal |
| | LED B | green, if Clock and Framed available flashing green, if only Clock available flashing yellow, if only Framed available off, if no signal |

Pin assignment of the RJ-45 jacks (input 3 + 4)

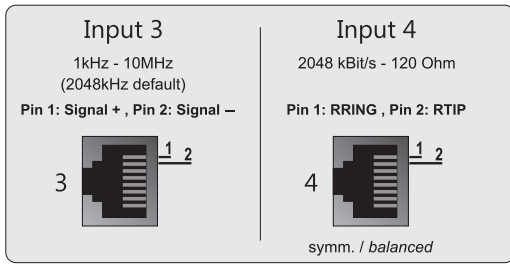

11.5.9.1 ESI Configuration via Web Interface

ESI – External Synchronization Input

Menu "IO Config -> Input Configuration -> ESI - External Synchronization Interface"

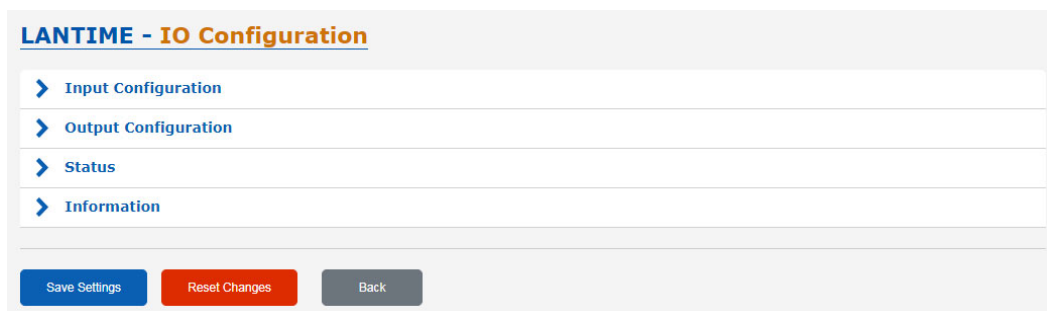

The ESI (External Synchronization Input) card is capable of adding additional synchronization sources to an IMS system. It accepts E1 and T1 sources as a Bitstream (2.048 MBit/s/1.544 Mbit/s, supporting SSM/BOC).

It also handles configurable frequencies (1 kHz - 20 MHz) and 1PPS pulse synchronization source, if required. An ESI card is, as the MRI card, dedicated to one specific clock module (depending on the slot it is installed in) and can be installed in both ESI as well as MRI slots.

Configurable Inputs

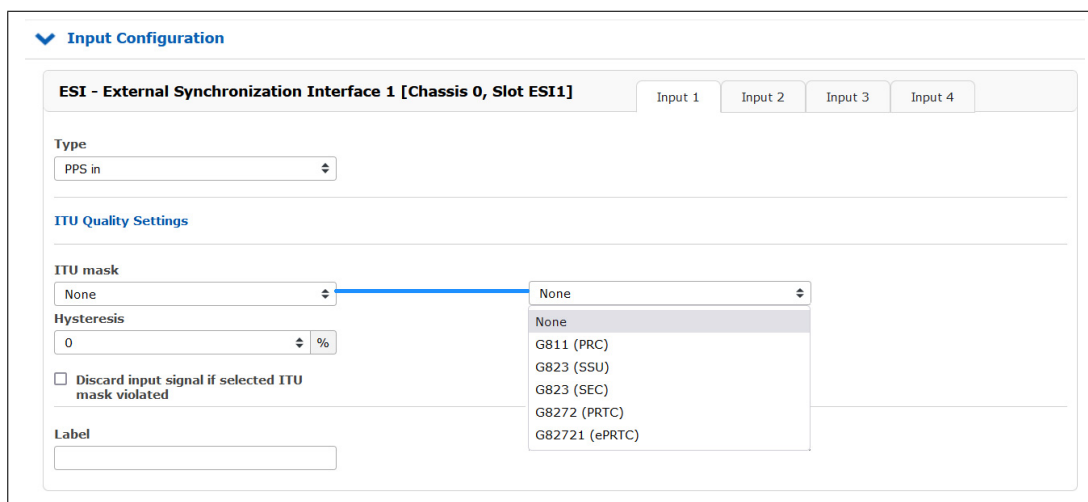

Input 1: The input 1 is dedicated to 1PPS (Pulse Per Second) synchronization.

Input Configuration

ESI - External Synchronization Interface 1 [Chassis 0, Slot ESI1] Input 1 Input 2 Input 3 Input 4

Type
Freq. In

Frequency
10 MHz

Maximum Slip
1.5 Cycles

ITU Quality Settings

ITU mask
None

Hysteresis
0 %

Discard input signal if selected ITU mask violated

Label

None
G811 (PRC)
G823 (SSU)
G823 (SEC)
G8272 (PRTC)
G82721 (ePRTC)

Input 2: accepts as input signal configurable frequencies from 1 kHz to 20 MHz.

Type: Freq. In

Frequency: Fill in a configurable frequency, 10 MHz is set as default value.

Maximum Slip in Cycles: A discontinuity of an integer number of cycles in the measured carrier phase resulting from a temporary loss of input signal. The maximum slip number can be selected in range between 0.5 – 3 cycles, with 1.5 as a default value.

Input 3: accepts as input signal configurable frequencies from 1 kHz to 20 MHz. 2048 kHz is set as default value.

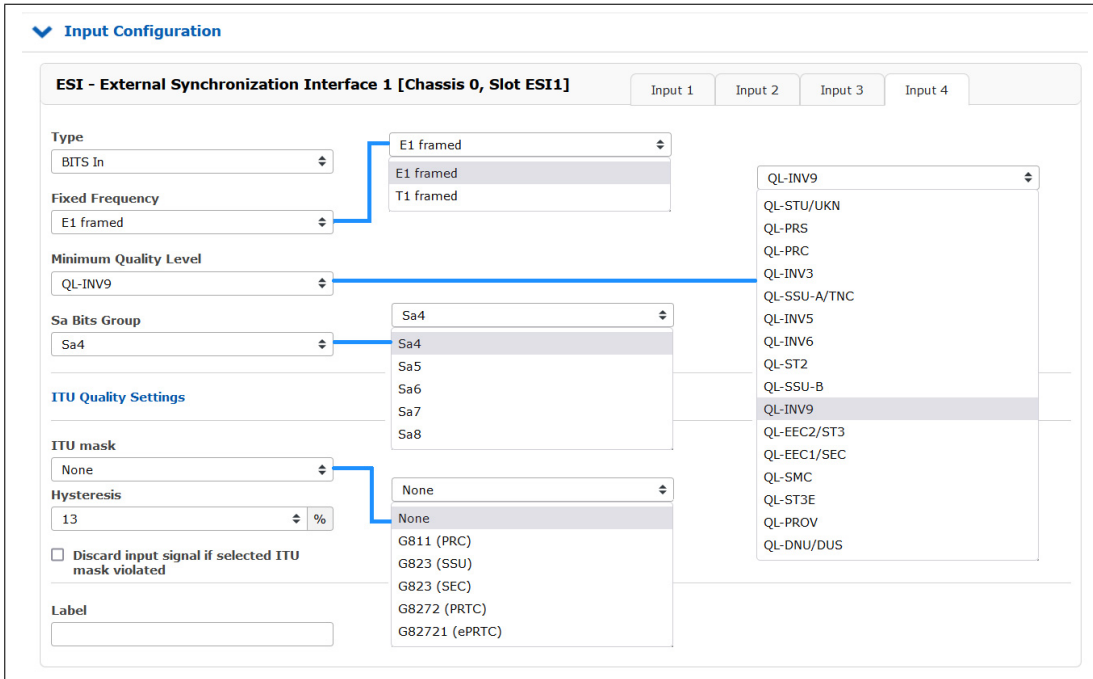

Input 4:
BITS In: As fixed frequency you can choose between E1 framed or T1 framed

Minimum Quality Levels: Synchronization Status Message (SSM) in accordance with ITU G.704-1998 standard includes 4 bit long SSM quality messages received via incoming E1 framed signal. The clock source quality levels according to G.704-1998 are as follows:

| | |
|--------------|---|
| QL-STU/UKN | Quality unknown, existing synchronization network |
| QL-PRS | Primary Reference Source |
| QL-PRC | Primary Reference Clock - Rec. G.811 |
| QL-INV3 | reserved |
| QL-SSU-A/TNC | |
| QL-INV5 | reserved |
| QL-INV5 | reserved |
| QL-ST2 | |
| QL-SSU-B | |
| QL-INV9 | reserved |
| QL-EEC2/ST3 | |
| QL-EEC1/SEC | Synchronous Equipment Timing Source (SETS) |
| QL-SMC | |
| QL-ST3E | |
| QL-PROV | |
| QL-DNU/DUS | Do not use for synchronization |

Example:
 User configured QL-SSU-B as Minimum Quality Level for his system. E1 input signal coming from PRC (G.811) or TNC will be allowed for synchronization, whereas signal coming from Synchronous Equipment Timing Source (SETS) will not be accepted.

Sa Bits
 With Sa Bits you can select one of the Sa4 to Sa8 bits which is allocated for SSM quality messages.

11.5.10 VSI - Video Synchronization Input Card

Video signal input module

The VSI (Video Synchronization Input) card provides video signals to an IMS clock module as reference. It can process Black Burst (PAL), LTC (Linear Time Code) and programmable Word Clock Rates.

| | |
|----------------------------|---|
| Connectors: | 4 x BNC female |
| Input Signal: | <u>Black In</u> Black Burst (PAL) Input with VITC Reader Input with Prescaler mode (Frequency only) |
| Signal level: | 300 mV _{ss} into 75 Ω (unbalanced) |
| Time Code Formats: | PAL SMPTE259M / ITU-R BT.470-6 SMPTE12M-1 / SMPTE ST309M <u>LTC Input</u> LTC-Reader (25 fps) <u>Word Clock Input</u> |
| Input signal: | Word Clock Input with programmable frequency range |
| Signal level: | TTL |
| Frequency range: | 1 kHz - 10 MHz <u>PPS Input</u> |
| Input signal: | PPS (pulse per second) |
| Signal level: | TTL |
| Pulse length: | ≥ 5 μs, aktiv high |
| Power Requirements: | 5 V, +-5%, 300 mA |

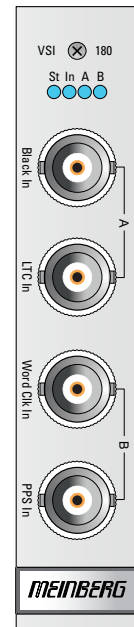

| | | |
|------------------------------|--------------------|--|
| Status Indicators | LED St: | Status of VSI180 |
| | LED In: | Synchronization status |
| | LED A | No function |
| | LED B: | No function |
| Operation conditions: | | |
| Initialisation: | LED St | blue during initialization green during operation |
| | LED In: | Shows status after initialization |
| | Green | Accurate |
| | Green Flashing | Timesync |
| | Yellow | Insufficient quality of the reference signal. |
| | Red | Reference signal not available / VSI180 is not synchronous |
| Normal Operation: | LED St / In | green |
| expiration LEDs: | ALL LEDs | 0,5 sec. red → 0,5 sec. yellow → 0,5 sec. green → 0,5 sec. off |

11.5.10.1 Configuration of VSI180 via Webinterface

VSI - Video Signal Input References

Menü "IO Config → Input Configuration → VSI-Module"

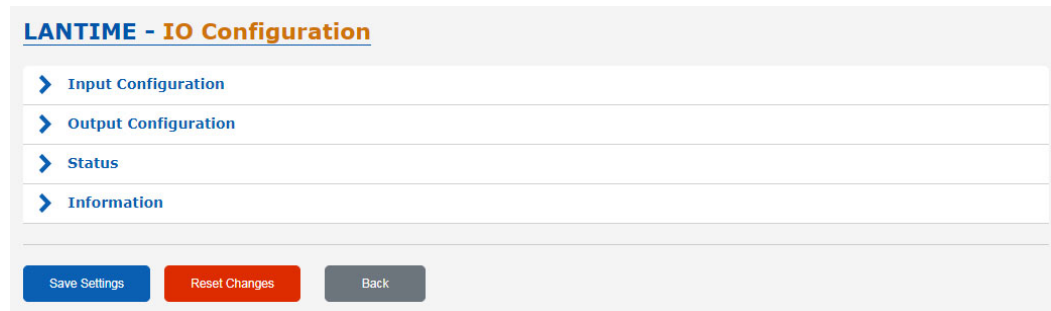

Video Sync Interface: configurable Inputs

| | |
|-------------------------|---------------------------|
| Input 1: | Video Sync In |
| Format: | PAL 625i |
| Epoch: | TAI |
| Signal Source: | Single-ended signal input |
| Time Code Modes: | VITC |
| Time Code Line: | 6 - 22 |

VSI - Video Sync Interface 1 [Chassis 0, Slot ES11] Input 1 Input 2 Input 3 Input 4

Input Type
 LTC In

Type
 LTC 25FPS

Label

Input 2: LTC In
Type: LTC 25 FPS (Frames per Second)

VSI - Video Sync Interface 1 [Chassis 0, Slot ES11] Input 1 Input 2 Input 3 Input 4

Output Type
 Freq. In

Frequency

Maximum Slip
 Cycles

Label

Unit dropdown menu:
 MHz
 Hz
 kHz
 MHz

Value dropdown menu:
 1.5
 0.5
 1.0
 1.5
 2.0
 2.5
 3.0

Input 3: Word Clk In
Frequency: 1 kHz - 10 MHz
Max Slip: 0.5 - 3.0 oscillations

VSI - Video Sync Interface 1 [Chassis 0, Slot ESI1] Input 1 Input 2 Input 3 Input 4

Port Type
PPS

Direction
Input

Operation Mode
Always enabled

Label

Input 4: PPS In

Pulse length: $\geq 5\mu\text{s}$, active high

11.5.10.2 Status Monitoring of the IMS-VSI

The submenu "Status" of the "IO Config" allows you to view the status of each port of the installed IMS-VSI module. In addition, the current operating temperature of the module is displayed in this menu.

VSI - Video Sync Interface 1 [Chassis 0, Slot ESI1]

| Output | Type | Status |
|--------|------|--------------------------------|
| Port 1 | GPIO | Input signal is currently lost |
| Port 2 | GPIO | Input signal is currently lost |
| Port 3 | GPIO | Input signal is avail |
| Port 4 | PPS | Input signal is avail |

| | | |
|-----------------------------|-----------------------------|-------------------------------------|
| Temperature Sensor 1 | Temperature Sensor 2 | Current Consumption Sensor 1 |
| Current: 33.25°C | Current: 34.75°C | Current: 0.30A |

11.5.10.3 Status Monitoring of the IMS-VSI

The submenu "Status" of the "IO Config" allows you to view the status of each port of the installed IMS-VSI module. In addition, the current operating temperature of the module is displayed in this menu.

| VSI - Video Sync Interface 1 [Chassis 0, Slot ESI1] | | |
|---|------|--------------------------------|
| Output | Type | Status |
| Port 1 | GPIO | Input signal is currently lost |
| Port 2 | GPIO | Input signal is currently lost |
| Port 3 | GPIO | Input signal is avail |
| Port 4 | PPS | Input signal is avail |

| | | |
|-----------------------------|-----------------------------|-------------------------------------|
| Temperature Sensor 1 | Temperature Sensor 2 | Current Consumption Sensor 1 |
| Current: 33.25°C | Current: 34.75°C | Current: 0.30A |

11.5.11 IMS Network Modules

11.5.11.1 LNE-GbE: Network Expansion with Gigabit Support and SFP Option

Link speed: 10/100/1000 Mbit

Connector Type: 8P8C (RJ45)

Cable: CAT 5.0

Duplex Modes: Half/Full/Autonegotiaton

LED Indicators

LED St: blue during initialisation

LED In - LED B: Shows the state of the four LAN ports after initialisation

| | |
|-------|--------------------|
| green | normal operation |
| red | defective LAN port |

*Figure right:
LNE-GbE and LNE-GbE with SFP Option*

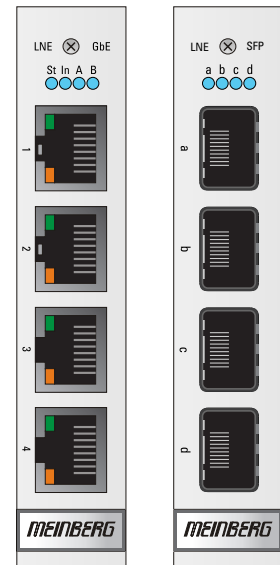

Option: LNE-SFP

Interface: 1000BASE-T SFP

Cable: Multimode Fiber
GI 50/125 μm or GI 62.5/125 μm gradient fiber

Singlemode Fiber
E9/125 μm monomode fiber

Link Speed Electrical: 1000 Base-T
Fiber optical: 1000-FX

LAN interface alignment with several LNE modules in operation:

Basically, the physical network ports are assigned according to the MAC address order. Thus, the uppermost interface on a LNE module has the lowest and the bottommost interface has the highest MAC address, respectively. Let's take an example where three LNE modules are inserted in a device. Then the logical order of network interfaces assigned in a webinterface follows the MAC address order of LNE modules, disregarding the I/O slot order by which the modules are inserted.

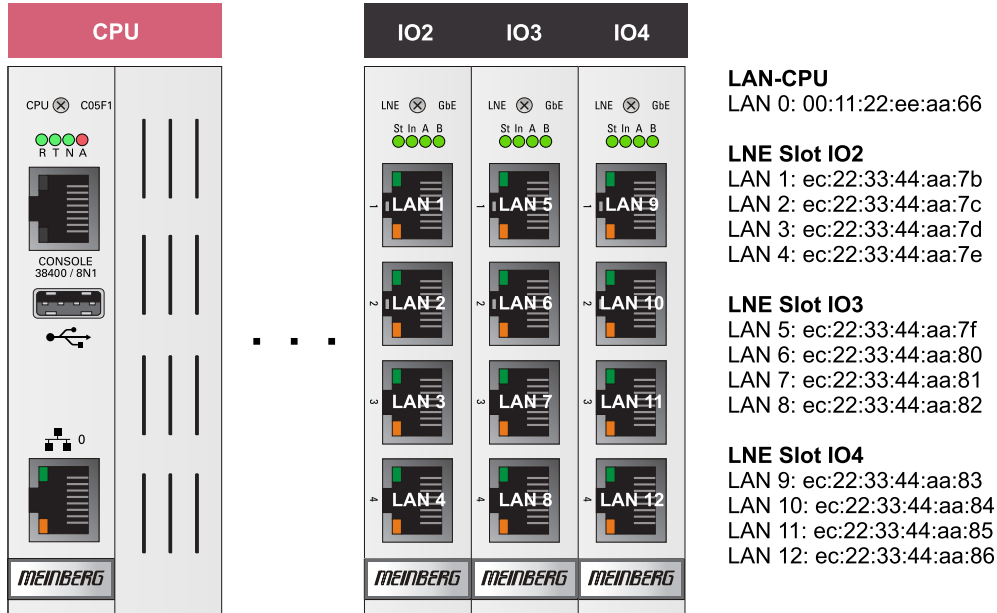

In a factory assembling, LNE modules are sorted in an ascending order starting from left to right (see the corresponding figure above). LAN 0 is therefore always the first network interface of the LAN-CPU.

11.5.11.2 LNE-GBE Configuration via the Web Interface

If the LNE-GBE operates in an LANTIME system, all network settings can be configured via the web interface then.

The screenshot shows the 'Physical Network Configuration' web interface. It features a table with columns for 'Interface', 'LAN0', and 'LAN1'. The 'Bonding' dropdown menu is open, showing options: 'Assigned to Bond 1', 'Single Connection', 'Assigned to Bond 0', 'Assigned to Bond 1', 'Assigned to Bond 2', 'Assigned to Bond 3', 'Assigned to Bond 4', 'Assigned to PRP 0', 'Assigned to PRP 1', 'Assigned to PRP 2', 'Assigned to PRP 3', and 'Assigned to PRP 4'. The 'Assigned to Bond 1' option is highlighted in blue.

| Interface | LAN0 | LAN1 |
|-----------------------------|-------------------------------------|--------------------------|
| Net Link Mode | AUTO | AUTO |
| Monitor Interface | <input checked="" type="checkbox"/> | <input type="checkbox"/> |
| Bonding | Assigned to Bond 1 | Assigned to Bond 1 |
| Bonding Status | ACTIVE | PASSIVE |
| IPv6 Mode | Activated | Deactivated |
| MAC Address | 00:13:95:2e:cd:f8 | ec:46:70:02:00:e3 |
| Assigned Virtual Interfaces | 01 | 02 |
| Port Power Status | ON | ON |

Physical Network Configuration

Net Link Mode: The network interfaces LAN1 - LAN4 (LNE-GBE) can be used in 1000 MBIT HALF / FULL duplex mode.

Indicate Link: LED indication for the selected physical interface, only if a front display with function keys is available.

Bonding: to optimize the reliability and the use of a of higher bandwidth.

PRP: As of LANTIME firmware version 7.0, PRP can also be conveniently set via the web interface menu "Network → Physical Network Configuration". Select the same PRP group for at least two interfaces in the drop-down menu "Bonding".

IPv6 Mode: This mode must be activated here.

MAC-Address: Displays the unique MAC address of the physical interface.

Assigned Virtual Interfaces: In the Ethernet Interfaces menu (see below) virtual network interfaces can be added.

Menu Interfaces

Network Interfaces

Add Interface

Interface 01 - lan0:0 IPv4 IPv6 Misc VLAN Cluster

Interface 02 - lan0:1 IPv4 IPv6 Misc VLAN Cluster

Interface 03 - lan0:2 IPv4 IPv6 Misc VLAN Cluster

Assigned Interface: LAN0

Virtual Interface: Delete Interface

MAC Address: 00:13:95:2e:cd:f8

Label:

- IPv4: Manually adjustment of all important parameters such as TCP / IP address, subnet mask and gateway. The DHCP client can also be activated here for automatic network configurations.
- Misc: With the tab Misc the virtual interface can be assigned to a physical interface.
- VLAN: With VLAN, this function can be enabled and configured.
- Cluster: The cluster function can be activated with this submenu and additional Parameters such as multicast or unicast mode, TCP / IP address and subnet mask can be set up here.

11.5.11.3 Adding / Removing an LANTIME Network Extension LNE

An LNE module can be installed in each MRI/ESI or IO Slot of a LANTIME IMS device.

Adding a LANTIME Network Extension

After installing the LNE module, please start the web interface. In the menu "System → Services and Functions" press the button **NIC Manager** then . With this function you add all new physical network interfaces to the system's network configuration. Now it is ensured that the IMS module is correctly installed and recognized by the system.

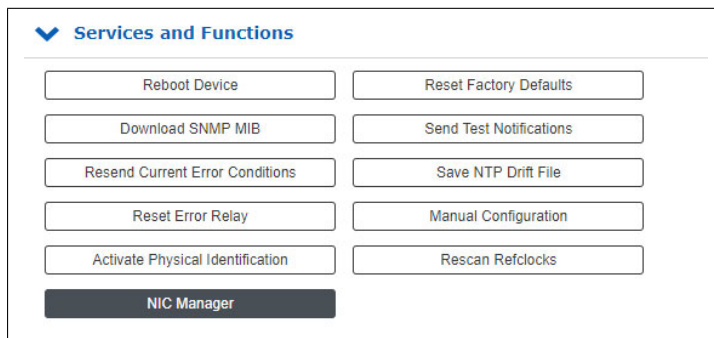

Remove a LANTIME Network Extension LNE

To remove a LNE network extension from the LANTIME system, the card must first be removed. However, the removed LNE interfaces are still listed in the network configuration. The "NIC Manager" can be used to update the network configuration in this case as well.

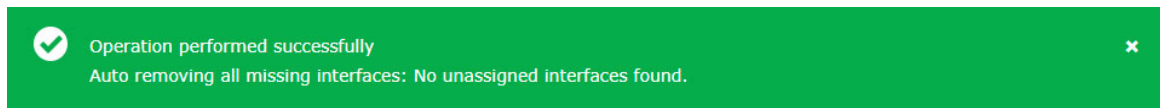

After successfully running the "NIC Manager", only the actually existing interfaces are displayed in the web interface. A system restart is not necessary.

11.5.11.4 HPS-100: PTP / SyncE / Hardware NTP Interface

IEEE 1588 v2 compatible

| | |
|-----------------------|---|
| Profiles: | IEEE 1588v2 Default Profile IEEE 1588v1 (option) Enterprise Profile IEC 61850-9-3 Power Profile IEEE C.37.238-2011 Power Profile IEEE C.37.238-2017 Power Profile ITU-T G.8265.1 Telecom Frequency Profile ITU-T G.8275.1 Telecom Phase / Time Profile (full timing support) ITU-T G.8275.2 Telecom Phase / Time Profile (partial timing support) SMPTE ST 2059-2 Broadcast Profile IEEE 802.1AS TSN/AVB Profile AES67 Media Profile DOCSIS 3.1 |
| PTP Modes: | Multicast/Unicast Layer 2 (IEEE 802.3) Multicast/Unicast Layer 3 (UDP IPv4/IPv6) Hybrid Mode E2E / P2P Delay Mechanism Up to 128 messages/second per client |
| NTP Mode: | NTP Server mode (8 ns time stamp accuracy) NTPD Software Service (15,000 req./s) |
| 1588 Clock Mode: | 1-Step, 2-Step for both Master and Slave operation |
| Synchronous Ethernet: | Master and Slave Capability Compliant to ITU-T G.8261, G.8262 and G.8264 Ethernet Synchronization Messaging Channel (ESMC) Note: Please also refer to the chapter SFP Transceiver |
| Network Protocols: | IPv4, IPv6 DHCP, DHCPv6 DSCP IEEE 802.1q VLAN filtering/tagging IEEE 802.1p QOS |
| Ethernet Interface: | Combo Port: 1 x 100/1000BASE-T RJ45, 1 x GBIT SFP - Slot A list of tested and recommended optical transceiver modules can be found in chapter Option LNE-SFP |
| USB Interface: | USB 1.1 / USB 2.0 full-speed, Micro USB female connector |
| Signal Outputs: | 2x SMA (50 Ohm) connectors configurable signals: 1PPS, 10MHz, 2048kHz |
| CPU: | 825 MHz Cortex A9 Dual Core on SOC |
| Time Stamp Accuracy: | 8 ns |

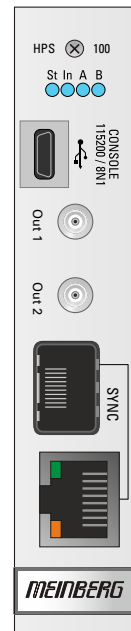

LED Indicators

LED St: Init lights blue during initialisation,
off in normal operation mode

LED In: red Error - TSU does not work correctly,
PTP services stopped
yellow No link, but initialized
green link up
red stopped

LED A - LED B: Shows the current State of the TSU

yellow - yellow Listening
green - off Master Mode
off - green Slave Mode
yellow - off Passiv Mode
off - yellow uncalibrated
red - red stopped

Performance Level Options:

| Option | Unicast Clients | Delay Req./s | NTP Req./s | PTPv1 | PTP Monitoring |
|--------|-----------------|--------------|------------|-------|----------------|
| PL-A | 8 | 1024 | 1600 | NO | NO |
| PL-B | 256 | 32768 | 51200 | NO | NO |
| PL-C | 512 | 65536 | 102400 | YES | NO |
| PL-D | 1024 | 131072 | 204800 | YES | YES |
| PL-E | 2048 | 262144 | 409600 | YES | YES |

A detailed configuration guide you will find in the corresponding firmware manual of the system. See chapter "The Web Interface -> Configuration: PTP V2".

PTP V2 Konfiguration

Schnittstelle 02 (Slot: IO1) Netzwerk Global SyncE Sonstiges Ausgänge NTP

Betriebsmodus
 Gesperrt PTP V2 PTP V1 NTP Monitor

Aktuelles Profil
 Custom

PTP Mode
 Multicast Slave Hybrid-Mode

Unicast Master Address 1 **Unicast Master Address 2**
 0.0.0.0

Delay Mechanism **Domain Number**
 E2E 0

Network Protocol
 UDP/IPv4 (L3)

Timescale **Priority1**
 PTP Standard (TAI) 128

Priority2
 128

Announce Interval **Sync Interval**
 1 announce message every 2 seconds 1 sync message per second

Delay Request Interval
 1 request message every 2 seconds

Interval Duration [s] **Announce Receipt Timeout**
 60 3

Alternate Time Offset Indicator
 Nein

Profilspezifische Einstellungen

| | |
|-------------------------|---------------------------------------|
| Power IEEE C37.238-2011 | Use Profile Extensions Nein |
| Telecom ITU-T G.8265.1 | Grandmaster ID 3 |
| Telecom ITU-T G.8275.1 | Network Inaccuracy 0 ns |
| SMPTE ST 2059-2 | |
| IEEE 802.1AS | |
| Utility IEC 61850-9-3 | |
| Power IEEE C37.238-2017 | |

Figure: Webinterface - PTP Menu → Global Configuration

11.5.11.5 TSU V3: IEEE-1588 Time Stamp Unit



Information:

This product is no longer available and is succeeded by the IMS-HPS100. Of course, we will continue to provide support for modules that have already been shipped. Our Support Team will be happy to assist you with any questions you may have.

TSU v3 (IEEE 1588 v2 compatible)

| | |
|-----------------------|--|
| Profiles: | IEEE 1588v2 Default Profile IEEE C.37.238 Power Profile ITU-T G.8265.1 Telecom Frequency Profile ITU-T G.8275.1 Telecom Phase/Time Profile SMPTE ST 2059-2 Broadcast Profile |
| PTP Modes: | Multicast Layer 2 (IEEE 802.3) Multicast/Unicast Layer 3 (UDP IPv4/IPv6) E2E / P2P Delay Mechanism Up to 128 Messages/Second per Client |
| NTP Mode: | NTP Server mode (10 ns Time Stamp Accuracy) |
| 1588 Clock Mode: | 1-Step, 2-Step for both Master and Slave Operation |
| Synchronous Ethernet: | Operable as Master or Slave Compliant with ITU-T G.8261, G.8262 and G.8264 Ethernet Synchronization Messaging Channel (ESMC) |
| Network Protocols: | IPv4, IPv6 DHCP, DHCPv6 DSCP IEEE 802.1q VLAN Filtering/Tagging |
| Ethernet Interface: | Combo Port: 1 x 100/1000BASE-T RJ45 1 x Gbit SFP |
| Signal Outputs: | 2x BNC (50 Ohm) Connectors Configurable Signals: Pulse-Per-Second, 10 MHz, 2048 kHz |
| CPU: | 1 GHz Dual-Core ARM |
| Time Stamp Accuracy: | 10 ns |

LED Indicators

| | | |
|-----------------|------------------------------------|---|
| "St" LED: | Init | Blue during initialization Off during normal operation |
| "In" LED: | Red | Error: TSU malfunctioning, PTP services stopped |
| | Yellow | No link, but initialized |
| | Green | Link established |
| | Red | Stopped |
| "A" & "B" LEDs: | Shows the current State of the TSU | |
| | Yellow - Yellow | Listening |
| | Green - Off | Master Mode |
| | Off - Green | Slave Mode |
| | Yellow - Off | Passive Mode |
| | Off - Yellow | Uncalibrated |
| | Red - Red | Stopped |

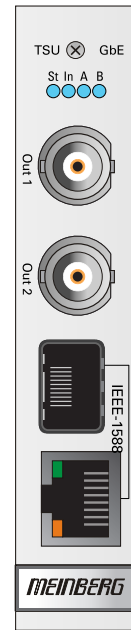

11.5.11.6 SFP Transceiver



Recommended and tested Transceivers from other Vendors

| Mode | Vendor/Type | Distance |
|--------------|------------------------------|----------|
| MULTI MODE: | AVAGO AFBR-5710PZ | 550 m |
| | FINISAR FTLF8524P3BNL | 500 m |
| SINGLE MODE: | AVAGO AFCT-5710PZ | 10 km |
| | FINISAR FTLF1318P3BTL | 10 km |
| | SMARTOPTICS SO-SFP-L120D-C63 | 80 km |
| RJ-45: | AVAGO ABCU-5740RZ | 100 m |
| | FINISAR FCLF8521P2BTL | 100 m |

Information:

Important Note for HPS100 Modules:

Since HPS firmware version ≥ 1.4 , an SFP Copper port is no longer supported. Therefore always use the native RJ45 port for your network copper lines.



Sending Synchronous Ethernet (SyncE) over Copper SFPs does not work!

The reason is because Copper SFPs have their own internal TCXO oscillators which are not adjustable so that the SyncE reference frequency that comes out of the system is not forwarded on the network. So the SyncE signal is free-running on a Copper SFP and therefore not useable for the next network node.

Please use a Fiber Optic SFP instead! The HPS100 module provides a native RJ45 port where SyncE via copper lines is possible.

Warning!



Prevention of Eye Injuries

- Fiber optic SFP modules that are not compliant with the definition of a Class 1 laser in accordance with IEC standard 60825-1 may emit radiation capable of causing eye injuries.
- Never look into an unconnected connector of a fiber optic cable or an unconnected SFP port, and ensure that unused fiber optic connectors are always fitted with a suitable protective cap.

11.5.12 CPE and BPE Output Modules (Frontend - Backend, Eurocard)

Configurable Port Expander / Backplane Port Expander

The standard output signals like pulses (1PPS, 1PPM and freely programmable pulses) and frequencies (10MHz, 2.048MHz, frequency synthesizer 1kHz-10MHz) are provided by two versatile I/O cards named BPE and CPE. Both of these two modules have been designed to cover a wide range of interface and signal/protocol requirements. They feature a two-tier architecture with a back-end and front-end.

The back-end is responsible for internally routing the backplane IMS synchronization signals (in case of the BPE) or for autonomously generating a wide range of different signals by using a microprocessor (on a CPE). The front-end makes a selection of the signals available on physical connectors.



BPE - Backend

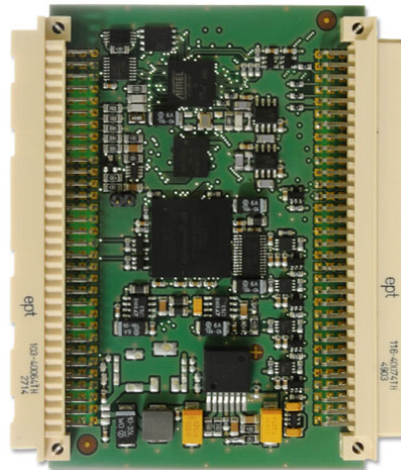

CPE - Backend

11.5.12.1 BPE - Backplane Port Expander

Please Note:

In principle, it should be noted that the signals that are provided via a BPE at the various connectors are always generated by the upstream clock and spread via the backplane of the system. In opposite to the CPE, the signals are not generated by the module and therefore the outputs can only be set via the receiver.

The selection and settings of the signals such as frequency, time code or programmable pulse outputs can be done via the web interface menu "Clock" or "Clock Switch Card "(for redundant systems).

Output Signals: fixed TTL signals:
10 MHz, PPS, IRIG DCLS, IRIG AM, 2.048 MHz,
PPOs (selectable via receiver)

Output Level: 5 V_{pp} without load
2.8 - 3.0 V_{pp} into 50 Ω

Power Requirements: 5 V ±5%, 150 mA / BNC
5 V ±5%, 150 mA / FO

Status Indicators

LED St: BPE status
LED In: Status of the backplane's output signals
LED A: BPE status - output signals (1 + 2)
LED B: BPE status - output signals (3 + 4)

Note: When pulse trains ≥ 1.6 s are configured, the LED assigned to the output remains "red" as these pulse trains are not monitored (e.g. PPM, PPH ...).

Initialisation: LED St: blue until USB is configured
LED In - LED B: off until USB is configured

USB is configured: LED St: blue
LED In - LED B:
0,5 sec. red -> 0,5 sec. yellow ->
0,5 sec. green -> 0,5 sec. off

Normal Operation: LED St. + LED In: green
LED A: green, if the desired signal is present on output 1 and output 2
LED B: green, if the desired signal is present on output 3 and output 4

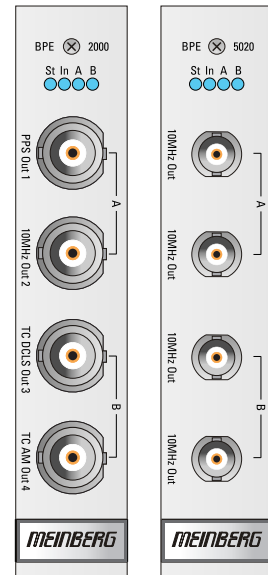

Figure right: BPE Outputs

BPE-2000 Standard outputs - BNC female:
PPS, 10 MHz, TC DCLS and TC AM

BPE 5000 Fiber Optic ST-Connectors
PPS, 10 MHz, TC DCLS und 2048kHz

11.5.12.2 Available BPE Modules

| BPE Type | Connectors | Signals | Size |
|-----------------------|----------------|--|------|
| BPE-1040 | 4 x BNC female | Out 1 - Out 4: TC AM | 4HP |
| BPE-1060 ¹ | 4 x BNC female | Out 1 - Out 4: DCF77 SIM | 4HP |
| BPE-2000 | 4 x BNC female | Out 1: PPS, Out 2: 10 MHz Out 3: TC DCLS, Out 4: TC AM | 4HP |
| BPE-2001 | 4 x BNC female | Out 1: PPS, Out 2: 10 MHz Out 3: TC DCLS, Out 4: TC DCLS | 4HP |
| BPE-2010 | 4 x BNC female | Out 1 - Out 4: PPS | 4HP |
| BPE-2014 | 4 x BNC female | Out 1 - Out 2: PPS Out 3 - Out 4: 10 MHz | 4HP |
| BPE-2016 ² | 4 x BNC Buchse | Out 1 - Out 4: progr. Pulses_1 10 V _{PP} an 50 Ω | 4TE |
| BPE-2020 | 4 x BNC female | Out 1 - Out 4: 10 MHz | 4HP |
| BPE-2030 | 4 x BNC female | Out 1 - Out 4: TC DCLS | 4HP |
| BPE-2050 | 4 x BNC female | Out 1 - Out 3: TC DCLS Out 4: TC AM | 4HP |
| BPE-2080 | 4 x BNC female | Out 1 - Out 4: 2048 kHz | 4HP |
| BPE-2090 | 4 x BNC female | Out 1 - Out 4: progr. Pulses | 4HP |
| BPE-2091 ³ | 4 x BNC female | Out 1 - Out 4: progr. Pulses_1 | 4HP |

(1) When using the BPE-1060 module, important configuration parameters must be observed. In the web interface, you must set the mode to DCF77 Marks in the "Clock → Programmable Pulse Outputs → Prog. Out 1" menu. In the drop-down box "Signal" the setting Normal is to be selected. In the menu "Clock → Time Zone → Time Zone for external Outputs" the *Local Time Zone* must be selected.

If the corresponding time zone does not exist in this drop-down box, the time zone can be added manually in the menu "System → Display → Edit Time Zone Table".

Also see BPE-1060 4 x SIM77

(2) The outputs can be set by jumpers. Possible options are: PPS, Time Code DCLS, PPO_0, PPO_1, PPO_2 and PPO_3. Default jumper setting of this card is 4 x PPO_0 (Progr. Output 1 in the web interface).

(3) All four outputs of this BPE module have to be configured via the upstream receiver. In the web interface, the configuration of the output signals can be carried out via the menu "Clock → Programmable Pulse → Prog. Out 1". Here the option "PTTI 1PPS" must be selected to get a pulse length of 20μs.

| BPE Type | Connectors | Signals | Size |
|----------|--|---|------|
| BPE-2110 | 8 x BNC female | Out 1 - Out 8: PPS | 8HP |
| BPE-2120 | 8 x BNC female | Out 1 - Out 8: 10 MHz | 8HP |
| BPE-2180 | 8 x BNC female | Out 1 - Out 8: 2048 kHz | 8HP |
| BPE-2500 | 4 x 2pin DFK PhotoMOS 1 x BNC female | Out 1 - Out 4: Progr. Pulse Out 5 - TC AM | 4HP |
| BPE-2600 | 4 x 2pin DFK | Out 1: PPS, Out 2: 10 MHz Out 3: TC DCLS, Out 4: TC AM | 4HP |
| BPE-2700 | 4 x 2pin DFK Opto Coupler 1 x BNC female | Out 1 - Out 4: Progr. Pulses Out 5 - TC AM | 4HP |

BPE modules with serial ports (D-SUB9 jacks)

| BPE Type | Connectors | Signals | Size |
|-----------------------|-------------------------------------|---|------|
| BPE-3014 | 2 x D-SUB9 female | Out 1, Out 2: TC DCLS RS-422 Level | 4HP |
| BPE-3050 ⁴ | 2 x D-SUB9 female | Out 1, Out 2: Progr. Pulse RS-422 Level | 4HP |
| BPE-3412 | 1 x D-SUB9 female 2 x BNC female | Out 1: Progr. Pulses, RS-422 Out 2, Out 3: TC AM | 4HP |
| BPE-3422 | 4 x D-SUB9 female | Out 1 - Out 4: 1MHz RS-422 Pegel | 8HP |
| BPE-3424 | 4 x D-SUB9 female | Out 1 - Out 4: TC DCLS RS-422 Pegel | 8HP |
| BPE-3082 | 4 x D-SUB9 female | Out 1 - Out 4: 2048 kHz sine | 8HP |

(4) The outputs COM A and COM B are configured via the upstream receiver in the web interface (Menu "Clock → Programable Pulses → Prog. Out 1"). The programable pulses PP_0 of the clock are connected to both outputs of the BPE-3050 via the backplane.

| BPE Type | Connectors | Signals | Size |
|------------------------------|----------------|--|------|
| BPE-4043 | 4 x RJ45 | RS422, Pin_3 T-, Pin_6 T+ | 4HP |
| BPE-6042 | 2 x DMC 16-pin | 10 x PPO - RS-422 galvanic isolated | 4HP |
| Fiber-Optical Outputs | | | |
| BPE-5000 | 4 x FST | PPS, 10 MHz, TC-DCLS, 2048 kHz FO Multimode | 4HP |
| BPE-5010 | 4 x FST | PPS / FO Multimode | 4HP |
| BPE-5014 | 4 x FST | 2 x PPS + 2 x 10 MHz / FO Multimode | 4HP |
| BPE-5020 | 4 x FST | 10 MHz / FO Multimode | 4HP |
| BPE-5030 | 4 x FST | TC DCLS / FO Multimode | 4HP |
| BPE-5032 | 4 x FST | TC DCLS / FO Singlemode | 4HP |
| BPE-5080 | 4 x FST | 2048 kHz / FO Multimode | 4HP |
| BPE-5082 | 4 x FST | PPS, 10 MHz, 2 x 2048 kHz FO Multimode | 4HP |
| BPE-5090 | 4 x FST | PPO / FO Multimode | 4HP |

11.5.12.3 Configuring an BPE expansion card via the Web Interface

A simple BPE expansion card usually gets its signals directly from the internal backplane of the system. The output signals of the card are pre-configured according to customer requirements.

If an output signal has to be changed, this must be done via the pre-connected receiver - in the menu "Clock → Switch Card" if you have a redundant system or in the menu "Clock → Receiver" in systems with only a single receiver. The BPE modules have no direct configuration options. This information is also displayed in the "IO Config" menu.

Figure: menu "Clock → Switch Card → IRIG Settings"

Figure: menu "Clock → Programmable Pulses → Selection of Idle mode"

11.5.12.4 BPE-8000 - Switchable Backplane Port Expander

Output Signals: adjustable via the web interface (TTL or Fiber Optical):
PPS, 10 MHz, 2048 kHz, TC-DCLS, Progr. Pulses
or fixed:
2048 kHz (ITU G.703-15), TC-AM

Power Requirements: 5 V +-5%, 150 mA / BNC
5 V +-5%, 150 mA / FO

Status Indicators

LED St: BPE status
LED In: Status of the backplane's output signals
LED A: BPE status - output signals (1 + 2)
LED B: BPE status - output signals (3 + 4)

Initialisation: LED St: blue until USB is configured
LED In - LED B: off until USB is configured

USB is configured: LED St: blue
LED In - LED B:
0,5 sec. red -> 0,5 sec. yellow ->
0,5 sec. green -> 0,5 sec. off

Normal Operation: LED St. + LED In: green
LED A: green, if the desired signal is present
on output 1 and output 2
LED B: green, if the desired signal is present
on output 3 and output 4

Available BPE-8000 Models

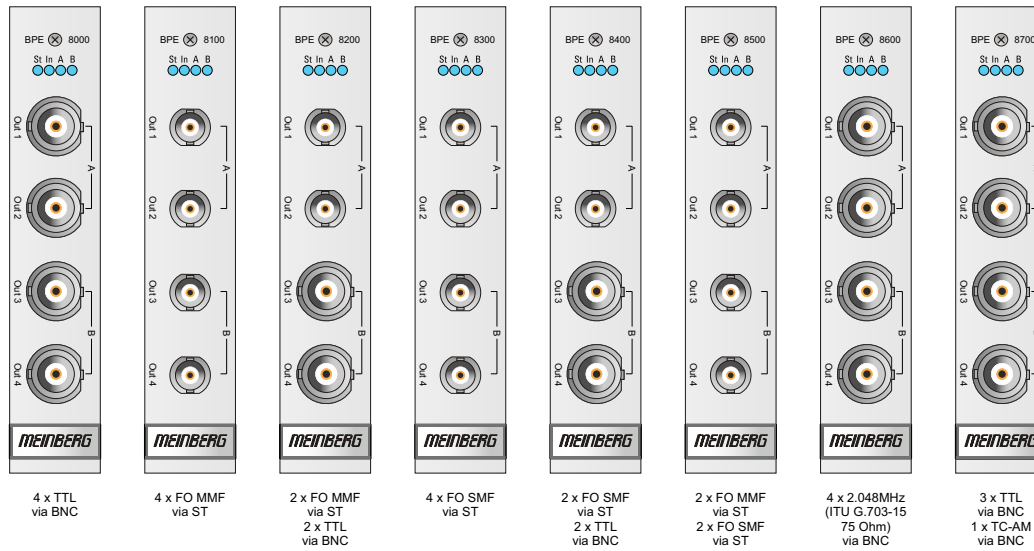

| BPE Module | Connectors | Signal Outputs |
|------------|----------------------|---|
| BPE-8000 | 4x BNC female | TTL |
| BPE-8100 | 4x ST | Fiber Optic - Multimode |
| BPE-8200 | 2x ST, 2x BNC female | 2x Fiber Optic - Multimode, 2x TTL |
| BPE-8300 | 4x ST | Fiber Optic - Singlemode |
| BPE-8400 | 2x ST, 2x BNC female | 2x Fiber Optic - Singlemode, 2x TTL |
| BPE-8500 | 4x ST | 2x Fiber Optic - Multimode, 2x Fiber Optic - Singlemode |
| BPE-8600 | 4x BNC female | 2048 kHz (ITU G.703-15 - 75 Ω unbalanced) * |
| BPE-8700 | 4x BNC female | 3x TTL, 1x Modulated Time Code - TC-AM ** |

* Fixed outputs, no signal selection possible.

** BNC sockets Out 1 - Out 3 are freely programmable, Out 4 is permanently set to TC AM.

11.5.12.5 Configuring an BPE-8000 expansion card via the Web Interface

Via the web interface or the Meinberg Device Manager (MDU), the following signals can be distributed to the BNC connectors (TTL) or fiber optical connectors (ST) according to your choice: PPS, 10MHz, Time Code DCLS, 2048 kHz and programmable pulse outputs PP 1 - PP 4 of the upstream reference source. With the programmable pulse outputs, each output channel of the pulse generator (IMS receiver) can now also be switched through to all available connectors of the BPE (for example PP 1 to Out 1 - Out 4 of the BPE).

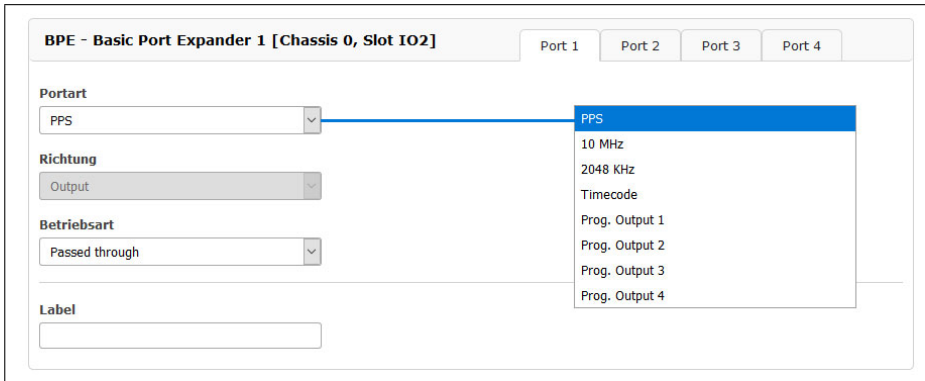

Figure: Web interface menu "IO Config → Output Configuration"

11.5.12.6 BPE-1060 4 x SIM77

Backplane Port Expander (Frontend / Backend)

Output Signals: fixed: Out 1 - Out 4: SIM77 (DCF77 compatible Signal)
via isolated female BNC connectors (-60 dBm)

Power Requirements: 5 V \pm 5%, 150 mA / BNC
5 V \pm 5%, 150 mA / FO

Status Indicators

LED St: BPE status
LED In: Status of the backplane's output signals
LED A: BPE status - output signals (1 + 2)
LED B: BPE status - output signals (3 + 4)

Initialisation: LED St: blue until USB is configured
LED In - LED B: off until USB is configured

USB is configured: LED St: blue
LED In - LED B:
0,5 sec. red -> 0,5 sec. yellow ->
0,5 sec. green -> 0,5 sec. off

Normal Operation: LED St. + LED In: green
LED A: green, if the desired signal is present
on output 1 and output 2
LED B: green, if the desired signal is present
on output 3 and output 4

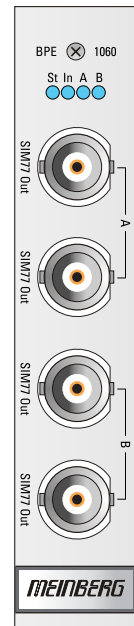

SIM77 - amplitude-modulated time signal

The amplitude-modulated time signal is compatible with the DCF77 signal, transmitted by the German long-wave transmitter. The SIM77 signal is provided via four DC insulated BNC sockets.

Programmable Output: Prog. Out 1 | Prog. Out 2 | Prog. Out 3 | Prog. Out 4

Mode: DCF77 Marks

Pulse Length: 400 ms

DCF Suspend After: 0 Minutes

On Time: 00:00:00

Off Time: 00:00:00

On Time: 00:00:00

Off Time: 00:00:00

On Time: 00:00:00

Off Time: 00:00:00

Signal: Normal

Disable Output in Holdover Mode

Note:

Important configuration parameters must be observed when using the BPE-1060 module in an IMS system. In the Web Interface, in the menu "Clock → Programmable pulse outputs → Prog. Out 1", the mode must be set to *DCF77 Marks*. In the "Signal" drop-down box, select *Normal* (see figure right).

The local time zone must be selected in the menu "Clock → Time Zone → Time Zone for External Outputs".

Switch Card: IRIG Settings | Programmable Pulses | Synthesizer | Time Zone

Enable Outputs | Miscellaneous | Initialize Receiver

Time Zone for External Outputs: (UTC+1) - CET/CEST

[Edit the time zone table in the display section of the system page. \(Link\)](#)

If the corresponding time zone is not available in this drop-down box, the time zone can be added manually in the menu "System → Display → Edit time zone table".

In the example below, several time zones are entered with the changeover rule for summer and winter time.

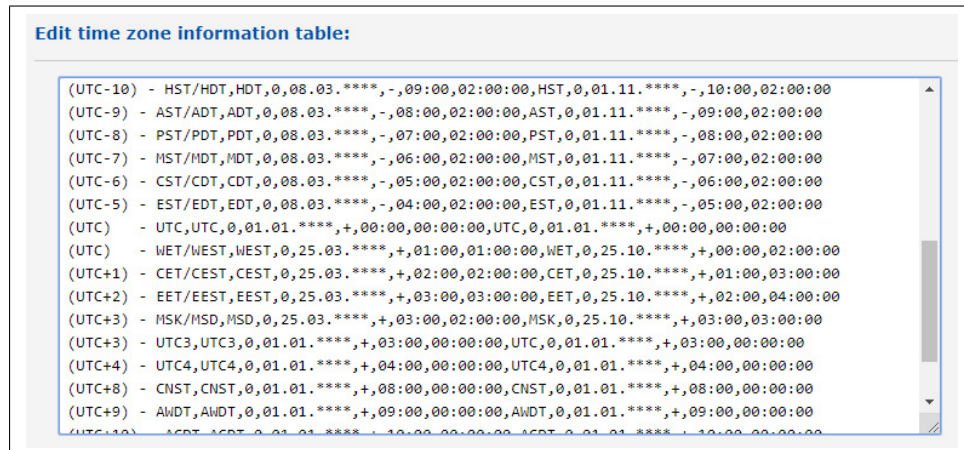

Please note, that these settings will also affect other output modules which provide the programmable pulse output "Prog. Out 1".

11.5.12.7 CPE - Configurable Port Expander (Frontend)

CPE (Configurable Port Expander)

The CPE is a configurable IO card that can autonomously generate additional output signals from the integrated system clock. This module consists of a half-size standard controller card (back-end) and a dockable port expander card (front-end), like this a wide variety of available programmable output signals and physical connections are possible, including various electrical and optical interfaces.

This enables the CPE, in combination with the front end COI TS2 (CPE 3000 ...), to support up to 4 more configurable interfaces that can optionally be led out as RS-232, RS-422 or RS-485 signal type. Furthermore, up to 8 programmable outputs (PPO) can be generated and configured in the web interface. The settings of the desired output configuration are selected in the IO Config -> Output Configuration.

It should be noted that the desired signals can be realized only with the corresponding front card.

Output Signals: configurable:
10 MHz, PPS, IRIG DCLS, IRIG AM, PPO

Capture-Input: active high or active low,
permitted input level +5 V (DC)

Power Supply: +5 V (DC), 150-300 mA,
depending on the selected frontend

Status Indicators

LED St: CPE status
LED In: Status of the backplane's output signals
LED A: currently not used
LED B: currently not used

LED Indicators

LED St: blue during initialisation
green normal operating mode

LED In: red no signal
yellow signal available / not sync
green flash time sync but not accurate
green time sync and accurate

LED A: green currently not used

LED B: green currently not used

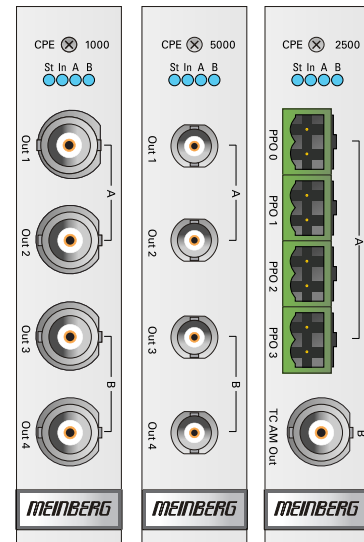

Figure: CPE Frontends

CPE-1000: 4 config. outputs via BNC female
CPE-5000: 4 config. outputs / FO - ST connectors
CPE-2500: 4 x prog. Pulses (DFK-2) / 1 x TC AM (BNC)

11.5.12.8 Available CPE Modules

| BPE Type | Connectors | Signals | Size |
|-----------------|--|--|-------------|
| CPE-1000 | 4 x BNC female | prog. pulses | 4HP |
| CPE-1002 | 1 x D-SUB9 2 x BNC female | Time Telegram, RS232 Capture Inputs | 4HP |
| CPE-1040 | 4 x BNC female | TC AM / BNC | 4HP |
| CPE-1050 | 4 x BNC female | 3 x progr. pulses, 1 x TC AM | 4HP |
| CPE-2500 | 4 x DFK 2-pin PhotoMos 1 x BNC female | progr. Pulse TC AM | 4HP |
| CPE-3000 | 2 x D-SUB9 | serial timestring RS-232 + PPO | 4HP |
| CPE-3010 | 2 x D-SUB9 | serial timestring RS-422 | 4HP |
| CPE-3020 | 2 x D-SUB9 | serial timestring RS-422 + PPO | 4HP |
| CPE-3030 | 2 x D-SUB9 | serial timestring RS-485 | 4HP |
| CPE-3040 | 2 x D-SUB9 | serial timestring RS-485 + PPO | 4HP |
| CPE-3050 | 2 x D-SUB9 | PPO - RS-422 | 4HP |
| CPE-3060 | 2 x D-SUB9 | serial timestring RS-422 + PPO | 4HP |
| CPE-4020 | 2 x RJ45 | serial timestring RS-422 + PPS | 4HP |
| CPE-5000 | 4 x FST female | prog. pulses / fiber optical | 4HP |

11.5.12.9 CPE-3000: Programmable Outputs via serial Interface

The CPE-3000 module has two serial ports (COM A and B) for various output signals. The two interfaces can also be used for communication with other devices.

The possible pin assignments and module types are listed below:

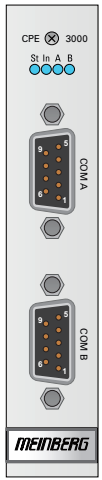

| | CPE-3000 | CPE-3010 | CPE-3020 | CPE-3030 | CPE-3040 | CPE-3050 | CPE-3060 | |
|-----|----------------------------|----------------------|-------------------------------------|----------------------|-------------------------------------|--------------|----------------------------------|-------------------------------------|
| | COM A, COM B | COM A, COM B | COM A, COM B | COM A, COM B | COM A, COM B | COM A, COM B | COM A | COM B |
| PIN | Time String (RS-232) + PPO | Time String (RS-422) | Time String (RS-422) + PPO (RS-422) | Time String (RS-485) | Time String (RS-485) + PPO (RS-422) | PPO (RS-422) | Time String (RS-232) + PPO (TTL) | Time String (RS-422) + PPO (RS-422) |
| 1 | PPO | RxD + | RxD + | - | - | - | PPO | RxD + |
| 2 | TxD | RxD - | RxD - | - | - | - | TxD | RxD - |
| 3 | RxD | - | TxD + | - | TxD + / RxD + | - | RxD | TxD + |
| 4 | - | - | TxD - | - | TxD - / RxD - | - | - | TxD - |
| 5 | GND | GND | GND | GND | GND | GND | GND | GND |
| 6 | - | - | - | - | - | - | - | - |
| 7 | - | TxD + | PPO + | TxD + / RxD + | PPO + | PPO + | - | PPO + |
| 8 | - | TxD - | PPO - | TxD - / RxD - | PPO - | PPO - | - | PPO - |
| 9 | - | - | - | - | - | - | - | - |

11.5.12.10 CPE - Configuration via Web Interface

If the CPE operates in an IMS system, the output configuration can easily be done via the web interface then.

With the "Common" tab the time zone with the corresponding offset can be selected.

CPE Configuration

In the "IO Config" menu you can select the following values for the output connectors:

| | |
|-------------|---|
| Common | Time zone with the corresponding UTC offset value |
| Synthesizer | Frequency Snthesizer range 1Hz - 10 MHz |
| IRIG Code | Generated IRIG output codes (B002+B122 ...) |
| Prog. Out | Programmable output Prog. Out 1 - Prog. Out 4 |

Figure: Menu Tab "Synthesizer" Frequency for selecting the Frequency Synthesizer option in the menu "Prog. Out"

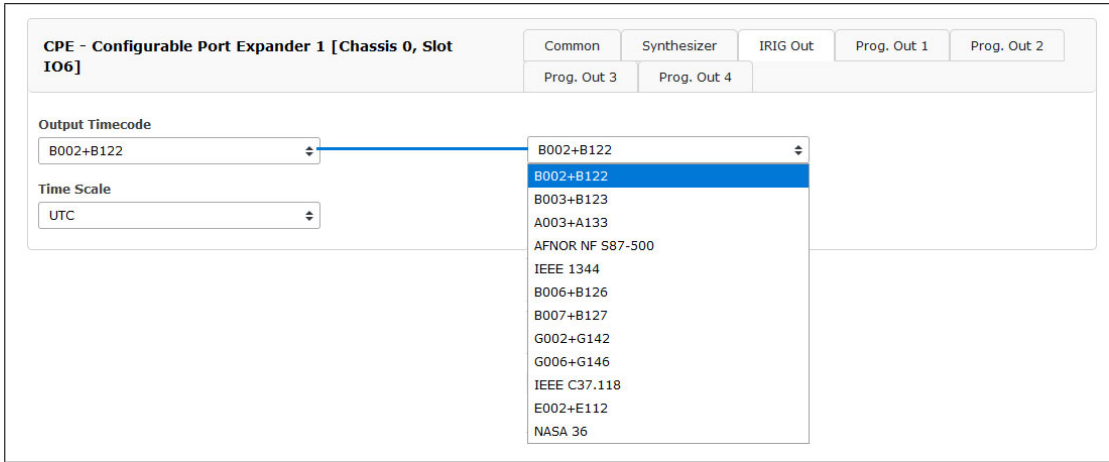

Figure: Menu Tab "IRIG Out" Selection of the IRIG code (IRIG DCLS only)

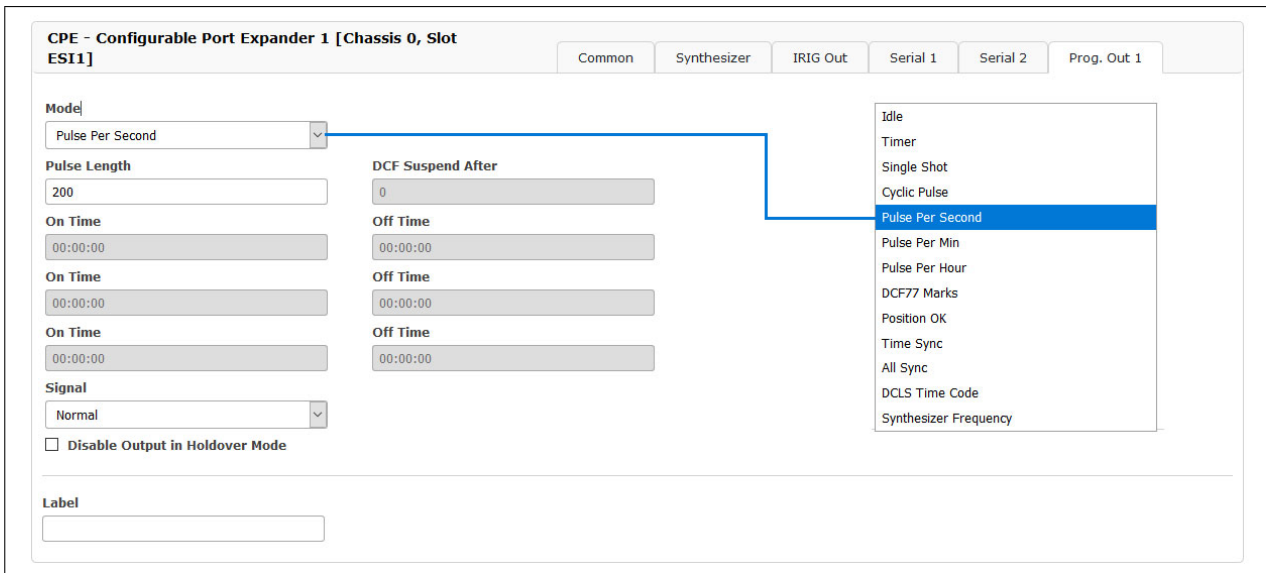

Figure: Menu Tab "Prog. Out" Selection of the signal option for the programmable pulse output (PPO)

The following programmable pulse outputs can be selected:

- Idle (not in use)
- Timer (3 switching-times On - Off)
- Single Shot (pulse length and start time)
- Cyclic Pulse (pulse length and cycle time)
- Pulse Per Second (pulse length)
- Pulse Per Minute (pulse length)
- Pulse Per Hour (pulse length)
- DCF77 Marks (timeout)
- Position OK (position determined)
- Time Sync (clock synchronized)
- All Sync (position determined and clock synchronized)
- DCLS Time Code
- Synthesizer Frequency

11.5.12.11 CPE-4020: Programmable Outputs via serial Interface

The module CPE-4020 has two interfaces with RJ45-connector (COM A and B). These provide Time String + PPS with RS-422 level. The following configurations must be performed to correctly output the signals.

| | |
|--------------------|------------------|
| Baud Rate | 19200 |
| Framing | 8N1 |
| String Type | Meinberg GPS |
| Mode | per second (PPS) |

Pin assignment

| | |
|--------|-------------------------------------|
| Pin 3: | TXD_P, serial interf. transmit pos. |
| Pin 5: | GND (Ground) |
| Pin 6: | TXD_N, serial interf. transmit neg. |
| Pin 7: | SYNC_P, PPS transmit, pos. |
| Pin 8: | SYNC_N, PPS transmit, neg. |

Current Consumption: 5 V +-5%, 150 mA

Connection type: 8P8C (RJ45)

Cable: Copper twisted pair,
e.g. CAT 5.0

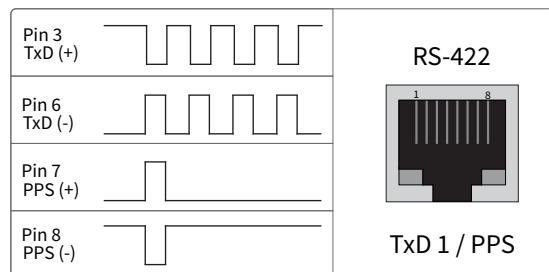
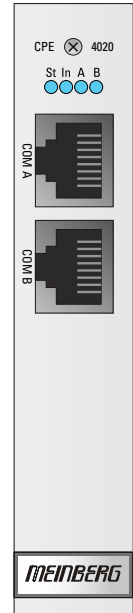

11.5.12.12 CPE-4020 Configuration via Web Interface

If the CPE-4020 operates in an IMS system, the output configuration can easily be done via the web interface then.

With the "Common" tab the time zone with the corresponding offset can be selected.

Configuration: CPE-4020

In the "IO Config" menu you can select the following values for the output connectors:

- Common:** Time zone with the corresponding UTC offset value
- Synthesizer:** Frequency Synthesizer range 1 Hz - 10 MHz
- IRIG Code:** Generated IRIG output codes (B002+B122 ...)
- Serial:** Serial connection parameters
- Prog. Out:** Programmable outputs Prog. Out 1 and Prog. Out 2

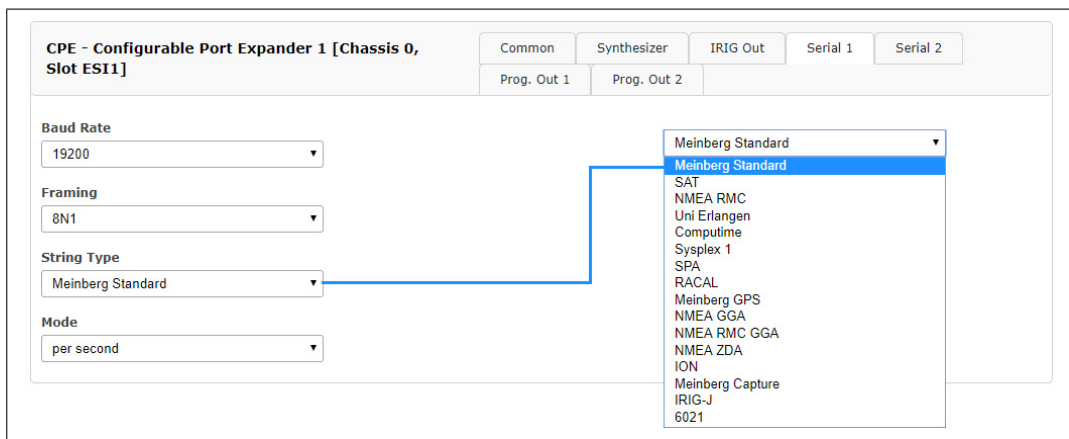

Figure: Serial connection parameter settings

The following programmable pulse outputs can be selected:

- Idle** (not in use)
- Timer** (3 switching-times On - Off)
- Single Shot** (pulse length and start time)
- Cyclic Pulse** (pulse length and cycle time)
- Pulse Per Second** (pulse length)
- Pulse Per Minute** (pulse length)
- Pulse Per Hour** (pulse length)
- DCF77 Marks** (timeout)
- Position OK** (position determined)
- Time Sync** (clock synchronized)
- All Sync** (position determined and clock synchronized)
- DCLS Time Code**
- Synthesizer Frequency**

CPE - Configurable Port Expander 1 [Chassis 0, Slot ES11]

Common Synthesizer IRIG Out Serial 1 Serial 2
Prog. Out 1 Prog. Out 2

Mode
Idle

Pulse Length
200

On Time
00:00:00

On Time
00:00:00

On Time
00:00:00

Signal
Normal

Disable Output in Holdover Mode

Label

DCF Suspend After
0

Off Time
00:00:00

Off Time
00:00:00

Off Time
00:00:00

Off Time
00:00:00

Idle

- Idle
- Timer
- Single Shot
- Cyclic Pulse
- Pulse Per Second
- Pulse Per Min
- Pulse Per Hour
- DCF77 Marks
- Position OK
- Time Sync
- All Sync
- DCLS Time Code
- Synthesizer Frequency

Figure: Selection of programmable pulse outputs

11.5.13 PIO180 - PPS or 10 MHz I/O Module

Technical Specifications:

Connectors: 4 x BNC female, isolated, individually switchable as input or output

Signal Options: PPS or 10 MHz

Status Indicators

LED St: PIO status
 LED In: Status of the backplane's output signals
 LED P: display for preset PPS
 LED C: display for preset 10 MHz

Initialisation: LED St: blue until USB is configured
 LED In - LED B: off until USB is configured

USB is configured: LED St: blue
 LED In:
 0,5 sec. red -> 0,5 sec. yellow ->
 0,5 sec. green -> 0,5 sec. off

Normal Operation: LED St. + LED In: green
 LED P: green, if card is preset to PPS
 LED C: green, if card is preset to 10 MHz

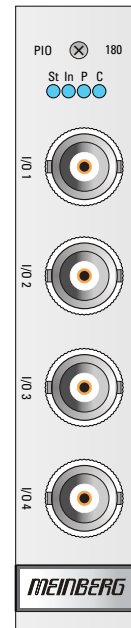

11.5.13.1 Pre-selection (PPS, 10 MHz)

Before installing the PIO180 module, select the required signal using the jumper setting (PPS or 10 MHz). Upon delivery all ports are preset to PPS (Pulse Per Second).

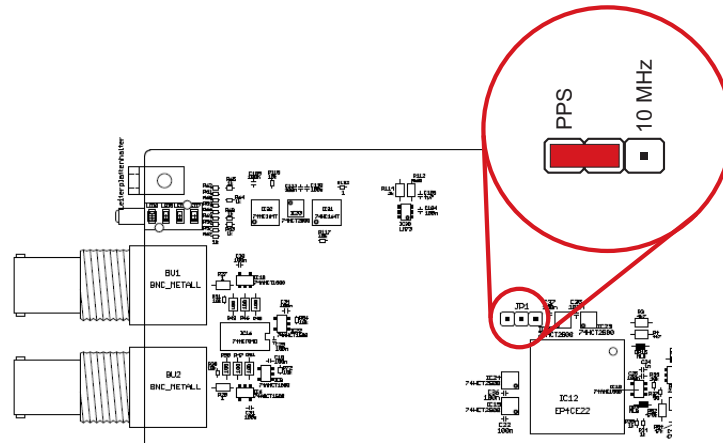

Information:

Mixed operation is not possible. All inputs/outputs are set to either PPS or 10 MHz.

11.5.13.2 PIO - Configuration via the Web Interface

In the "IO Config" menu of the web interface, each port of the PIO180 can be set separately to "Input" or "Output". To use the individual ports in **SyncMon**, the direction "Input" must be selected.

PIO - Programmable Input/Output Module 1
[Chassis 0, Slot IO3]

Port 1 Port 2 Port 3 Port 4

Portart
PPS

Richtung
Input
Input
Output

Enabled

Label

Via the web interface, each port can be set separately to "Input" or "Output". If a port is set to "Output", the system PPS or the 10 MHz reference frequency is output signal at this port. If a port is set to "Input" the incoming signal is compared to the system PPS or to the 10 MHz reference frequency. The offset values are displayed in the status window.

PIO - Programmable Input/Output Module 2 [Chassis 0, Slot ES11]

| Eingang | Art | Status | Offset |
|-----------|--------|---|---------------|
| Eingang 1 | PPS in | Carrier detected, Input signal is avail | -0.000000041s |
| Eingang 2 | PPS in | Carrier detected, Input signal is avail | -0.000000041s |
| Eingang 3 | PPS in | Input signal is currently lost | |
| Eingang 4 | PPS in | Input signal is currently lost | |

| Temperatursensor 1 | Temperatursensor 2 |
|--------------------|--------------------|
| Aktuell: 47.00°C | Aktuell: 45.00°C |

Download the Setup Guide on the PIO180 product page for more detailed information about the configuration and status monitoring options of the PIO180.

Download of the PIO180 Setup Guide:

<https://www.meinbergglobal.com/download/docs/manuals/english/ims-pio.pdf>

11.5.14 LIU - Line Interface Unit

Input signal: 2.048 MHz reference clock, TTL level

Clock: T1 - 1.544 MHz
E1 - 2.048 MHz

BITS: Framed Outputs 1544 kBit/s
or 2048 kBit/s (ESF - Extended Superframe)

T1 - 1.544 MBit/s
E1 - 2.048 MBit/s

Outputs: balanced - RJ45 jack - 120 Ω (Clock)
unbalanced - BNC connector 75 Ω (Bits)

Short term stability and Accuracy: depends on oscillator of the reference clock

OCXO-SQ: $\pm 5 \cdot 10^{-10}$

OCXO-MQ: $\pm 2 \cdot 10^{-10}$

OCXO-HQ: $\pm 5 \cdot 10^{-12}$

OCXO-DHQ: $\pm 2 \cdot 10^{-12}$

Rubidium: $\pm 2 \cdot 10^{-11}$

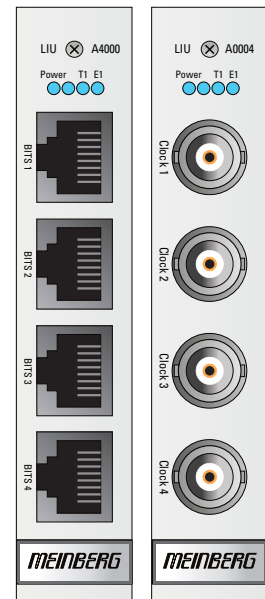

LED Indicators

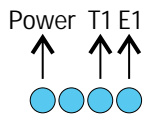

Power: Init blue during initialisation,
green in normal operation mode

T1: green selected mode T1
red: output disabled
yellow: signal quality unknown

E1: green selected mode E1
red: output disabled
yellow: signal quality unknown

11.5.14.1 IMS-LIU Telecom Output Signals

The board LIU (Line Interface Unit) was designed to convert the GNSS-locked standard frequency of a pre-connected Meinberg satellite controlled clock (GPS or GPS/GLONASS/Galileo/BeiDou) into several timing signals that can be used for various synchronization or measurement tasks.

Typical applications are:

- Measurement and test of synchronization quality of Telecom networks
- Calibration and synchronization of laboratory equipment
- Test of synchronization of radio transmitters / base stations (GSM / CDMA / UMTS / DAB / DVB)

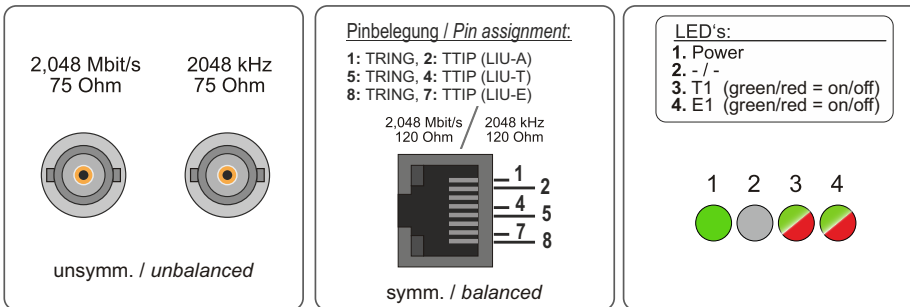

There are two separate signal paths on the board LIU. One is for providing the standard frequencies, the second path is for generation of the "telecom-signals". All output signals have high accuracy and stability because they are derived from the internal receiver's disciplined standard frequencies generated by the pre-connected satellite clock. Depending on the oscillator option of the internal receiver, the accuracies which are described in chapter LIU - Line Interface Unit can be achieved.

11.5.14.2 Block Diagram LIU

The following block diagram illustrates the functional principle of the board LIU:

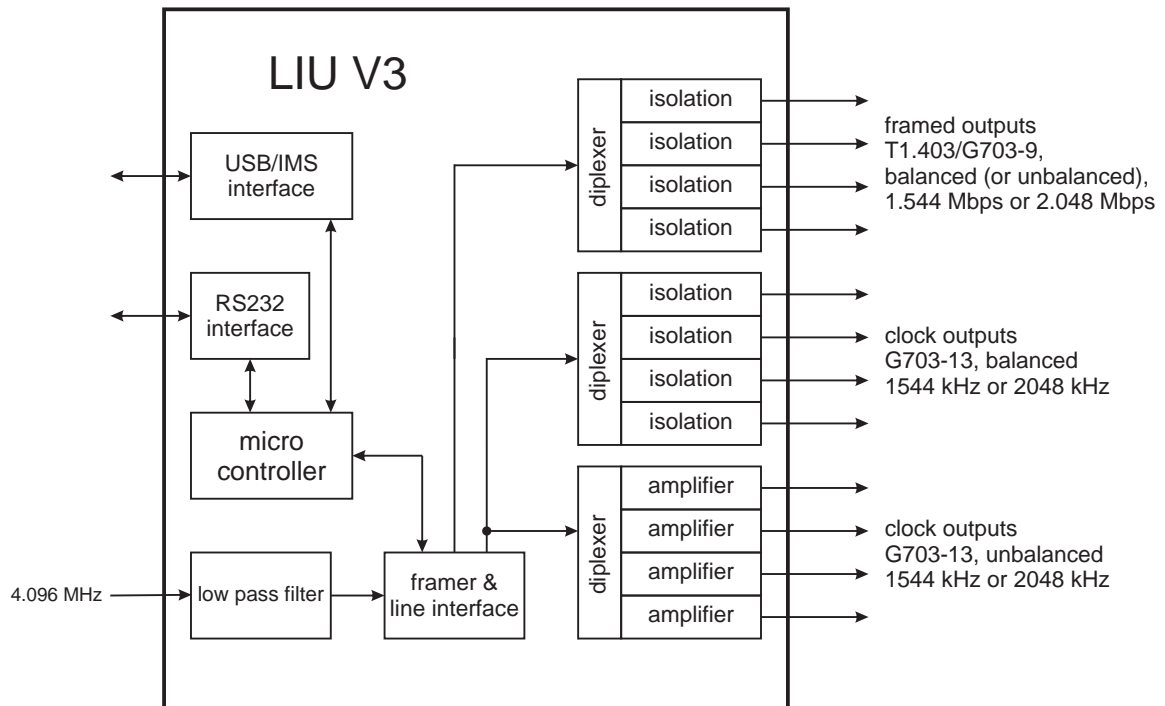

11.5.14.3 Telecom Signals

These signals can be divided into two groups: the "clock" outputs and the "framed" outputs, that are provided by a framer and line interface device on the board LIU. All clock signals needed for generation of the 'telecom outputs' are derived from a 2048 kHz reference clock, which is generated by a frequency synthesizer on the preconnected GPS- or GLN-clock. This synthesizer is phase locked to the PPS signal and frequency locked to the master oscillator of the clock.

The module LIU is able to generate signals for the American T1- or the European E1-system. The mode of operation can be configured via the web interface of the IMS management module (LAN-CPU).

The clock outputs are standard frequencies of either 1544 kHz (T1) or 2048 kHz (E1). Four unbalanced and four balanced outputs according to ITU-T G703-13 (CCITT recommendation "Physical/electrical characteristics of hierarchical digital interfaces") are available via BNC female and RJ45 connectors.

The "framed" outputs are consisting of data signals known from digital telephony, which are distributed by using a special frame structure (EFS Framing Mode - Extended Superframe). As a synchronization unit, LIU only generates a "framed all ones" signal (data byte 0xFF hex) with a transmission speed of either 1544 kBits (T1) or 2048 kBit/s (E1). Four outputs according to ANSI T.403 (T1-mode) or ITU-T G703-9 (E1-mode) are available either unbalanced via BNC connectors or balanced via RJ45 connectors. Two different line codes used for error correction are known for the transmission of framed signals. The board LIU generates B8ZS- (in T1-mode) or HDB3-coded (in E1-mode) output signals by standard.

11.5.14.4 Pulse templates

The following pulse templates are required by ANSI (T1-mode) and CCITT (E1-mode) for output signals in telecom applications. The board LIU meets these recommendations.

T1 (T.403):

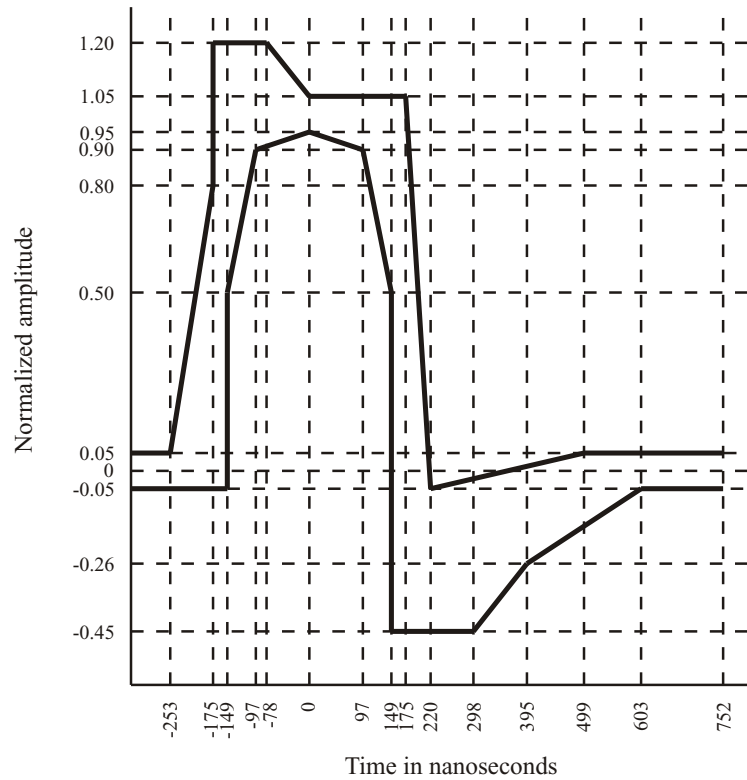

E1 (G.703):

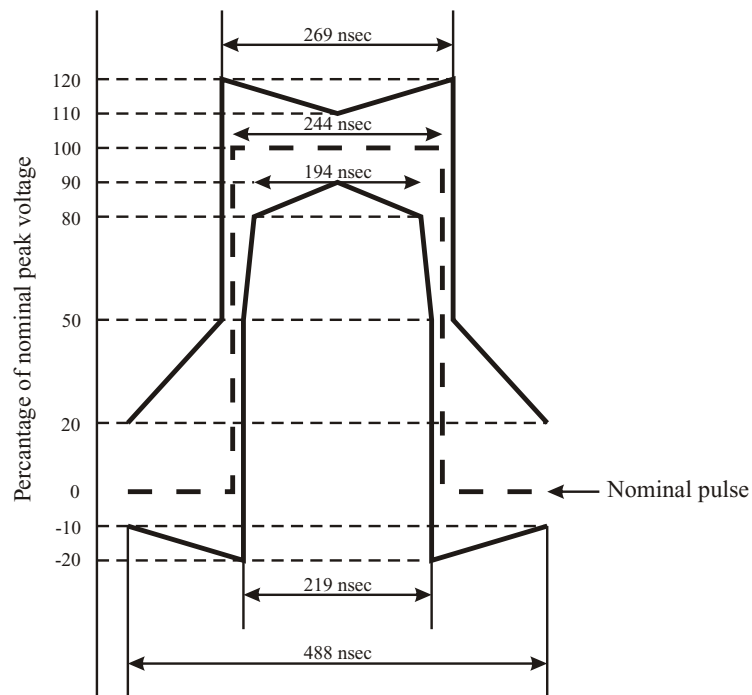

11.5.14.5 LIU - Configuration Samples

The Line Interface Unit (LIU) is available in two different sizes and different output / connector options. All outputs of a module can be operate in either the E1 or T1 in mode. Signal output settings can be done during operation via the web interface. The selected mode is indicated by the LEDs in the retainer plate.

Signal Types

- 2048 kHz (E1 mode) or 1.544 MHz (T1 mode), G.703, 120 Ω, balanced, RJ45 socket
- 2048 kHz (E1 mode) or 1.544 MHz (T1 mode), G.703, 75 Ω, unbalanced, BNC connector
- 2048 kBit/s (E1 mode) or 1.544 MBit/s (T1 mode), 120 Ω, balanced, RJ45 socket
- 2048 kBit/s (E1 mode) or 1.544 MBit/s (T1 mode), 75 Ω, unbalanced, BNC connector

11.5.14.6 Overview - LIU Modules for IMS Systems

| LIU Model | Size | Signal (bal./unbal.) | Connectors |
|-----------|------|---------------------------|--|
| LIU-A0040 | 4TE | Clock (4/0) | 4 x RJ45 |
| LIU-A0004 | 4TE | Clock (0/4) | 4 x BNC |
| LIU-A2020 | 4TE | BITS (2/0) Clock (2/0) | 2 x RJ45 2 x RJ45 |
| LIU-A2002 | 4TE | BITS (2/0) Clock (0/2) | 2 x RJ45 2 x BNC |
| LIU-A0400 | 4TE | BITS (0/4) | 4 x BNC |
| LIU-A1111 | 4TE | BITS (1/1) Clock (1/1) | 1 x RJ45, 1 x BNC 1 x RJ45, 1 x BNC |

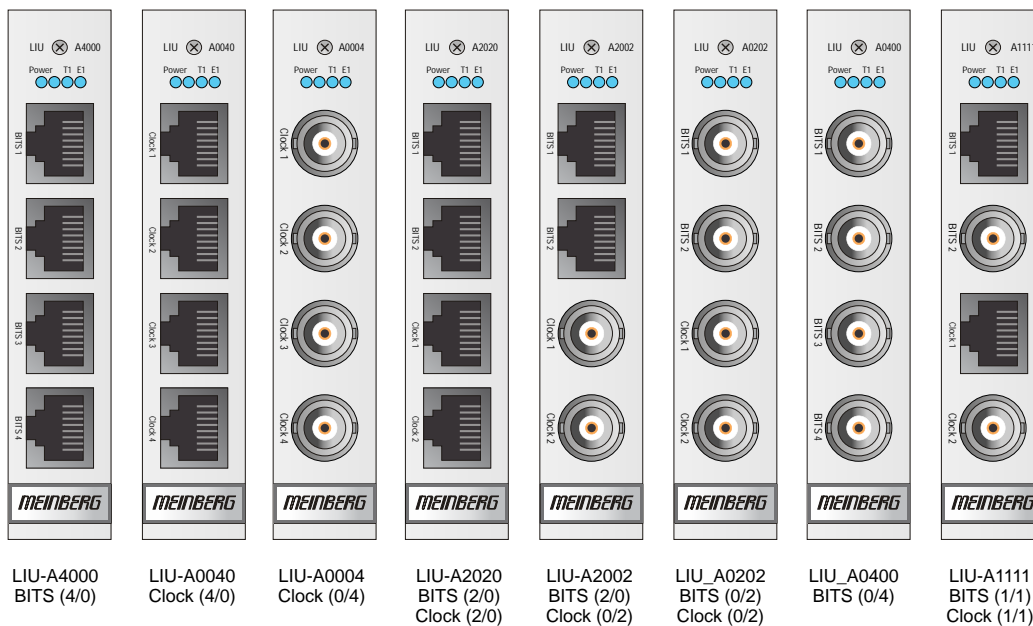

11.5.14.7 IMS - LIU Configuration

E1/T1 – generator available with 4 or 8 outputs

Generation of reference clocks for synchronization tasks. The module LIU (Line Interface Unit) generates different reference clock pulses which are derived from the GPS-locked master oscillator of a preconnected GPS clock. The output signals are available with high accuracy and stability therefore.

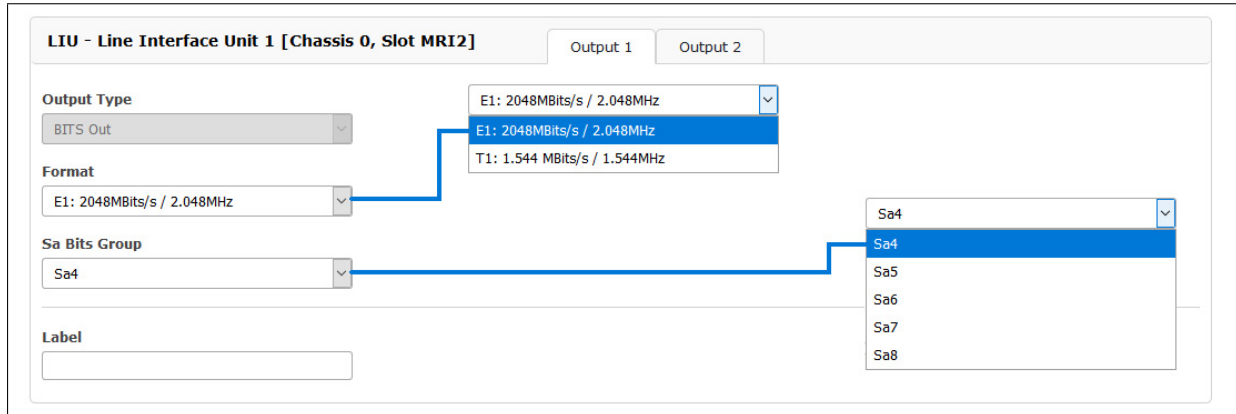

Figure: Configuration of the LIU module via the web interface menu "IO Config → Outputs Configuration"

Output Type

Clock Outputs: 2.048 MHz (E1-mode) or 1.544 MHz (T1-mode), G.703, 75 Ohm, unbalanced or 2.048 MHz (E1-mode) or 1.544 MHz (T1-mode), G.703, 120 Ohm, balanced.

BITS framed outputs with SSM/BOC support:
2.048 Mbit/s (E1-mode) or 1.544 Mbit/s (T1-mode), 75 Ohm unbalanced
or 2.048 MP/s (E1-mode) or 1.544 Mbit/s (T1-mode), 120 Ohm, balanced.

Format E1 framed (2.048 kBit) or T1 framed (1.544 kBit)

Quality Sa Bit group location of SSM QL bits

With the pull-down menu "Output Configuration" the available outputs of the I/O slots can be configured:

Output Configuration of a LIU module (Line Interface Unit):

In this menu one can select between E1 or T1 mode for the LIU outputs. The selected mode is the same for all outputs.

T1 or E1?

T1 is a digital carrier signal that transmits the DS - 1 signal. It has a data rate of about 1.544 Mbit/second. It contains 24 digital channels and therefore requires a device that has a digital connection.

E1 is the european equivalent to T1. T1 is the North American term whereas E1 is a European term for digital transmission. The data rate of E1 is about 2 Mbit/second. It has 32 channels at the speed of 64 Kbit/second. 2 channels among 32 are already reserved.

One channel is used for signaling while the other is used for controlling. The difference between T1 and E1 lies in the number of channels here.

Sa Bits

ITU-T Recommendations allow for bits Sa4 to Sa8 to be used in specific point-to-point applications (e.g. transcoder equipment) within national borders.

The Sa4 bit may be used as a message-based data link for operation, maintenance and performance monitoring. The SSM Bit (Synchronization Status Message) can be selected in the Web GUI for clock quality information. Sa4 is selected as default.

11.5.15 LNO - Sine Wave Outputs with low Phase Noise

The LNO180 is a 10 MHz (5 MHz option) generator card, which provides sine signals with low phase noise to 4 external outputs. The card has a microprocessor system, which monitors the output signals and generates status signals for the upper-level management system accordingly.

Function of Operation

The card has a high quality oscillator, which is locked to an external 10 MHz signal. The microprocessor monitors the lock status of the PLL and the warm up phase of the oscillator. It activates the outputs only after the phase is locked. This condition is signaled by all LEDs switched from green to red. In the phase locked state the output levels of the four outputs are monitored and in case of a failure signaled by an associated red LED.

Technical Specifications:

| | | | | | | | | | | | | | | | | | | | | | | | | | | | | | | | | | | | | | | | | | | | | | | | | | | | | | | | | |
|-------------------------|---|------------|-------------------------|--|--|------|---|-----------|-------|---|------------|--------|---|------------|-------|---|------------|--------|---|------------|-----------------------|--|--|------|---|-----------|-------|---|------------|--------|---|------------|-------|---|------------|--------|---|------------|-----------------------|--|--|------|---|-----------|-------|---|------------|--------|---|------------|-------|---|------------|--------|---|------------|
| Interface: | 4x sine outputs - 10 MHz or 5 MHz | | | | | | | | | | | | | | | | | | | | | | | | | | | | | | | | | | | | | | | | | | | | | | | | | | | | | | | |
| Output Level: | 5 dBm +/- 1 dBm at 50Ω (8 dBm or 12 dBm output level option available) | | | | | | | | | | | | | | | | | | | | | | | | | | | | | | | | | | | | | | | | | | | | | | | | | | | | | | | |
| Warm-up time: | < 3 @ 25 °C within accuracy of < +/-1 x 10 ⁻⁷ | | | | | | | | | | | | | | | | | | | | | | | | | | | | | | | | | | | | | | | | | | | | | | | | | | | | | | | |
| Harmonics: | -60 dBc | | | | | | | | | | | | | | | | | | | | | | | | | | | | | | | | | | | | | | | | | | | | | | | | | | | | | | | |
| Phase Noise: | <table> <tr> <td colspan="3"><u>LNO180 OCXO-SQ</u></td> </tr> <tr> <td>1 Hz</td> <td>-</td> <td>80 dBc/Hz</td> </tr> <tr> <td>10 Hz</td> <td>-</td> <td>100 dBc/Hz</td> </tr> <tr> <td>100 Hz</td> <td>-</td> <td>130 dBc/Hz</td> </tr> <tr> <td>1 kHz</td> <td>-</td> <td>140 dBc/Hz</td> </tr> <tr> <td>10 kHz</td> <td>-</td> <td>150 dBc/Hz</td> </tr> <tr> <td colspan="3"><u>LNO180 OCXO-MQ</u></td> </tr> <tr> <td>1 Hz</td> <td>-</td> <td>85 dBc/Hz</td> </tr> <tr> <td>10 Hz</td> <td>-</td> <td>110 dBc/Hz</td> </tr> <tr> <td>100 Hz</td> <td>-</td> <td>135 dBc/Hz</td> </tr> <tr> <td>1 kHz</td> <td>-</td> <td>143 dBc/Hz</td> </tr> <tr> <td>10 kHz</td> <td>-</td> <td>155 dBc/Hz</td> </tr> <tr> <td colspan="3"><u>LNO180 OCXO-HQ</u></td> </tr> <tr> <td>1 Hz</td> <td>-</td> <td>93 dBc/Hz</td> </tr> <tr> <td>10 Hz</td> <td>-</td> <td>126 dBc/Hz</td> </tr> <tr> <td>100 Hz</td> <td>-</td> <td>140 dBc/Hz</td> </tr> <tr> <td>1 kHz</td> <td>-</td> <td>145 dBc/Hz</td> </tr> <tr> <td>10 kHz</td> <td>-</td> <td>165 dBc/Hz</td> </tr> </table> | | <u>LNO180 OCXO-SQ</u> | | | 1 Hz | - | 80 dBc/Hz | 10 Hz | - | 100 dBc/Hz | 100 Hz | - | 130 dBc/Hz | 1 kHz | - | 140 dBc/Hz | 10 kHz | - | 150 dBc/Hz | <u>LNO180 OCXO-MQ</u> | | | 1 Hz | - | 85 dBc/Hz | 10 Hz | - | 110 dBc/Hz | 100 Hz | - | 135 dBc/Hz | 1 kHz | - | 143 dBc/Hz | 10 kHz | - | 155 dBc/Hz | <u>LNO180 OCXO-HQ</u> | | | 1 Hz | - | 93 dBc/Hz | 10 Hz | - | 126 dBc/Hz | 100 Hz | - | 140 dBc/Hz | 1 kHz | - | 145 dBc/Hz | 10 kHz | - | 165 dBc/Hz |
| <u>LNO180 OCXO-SQ</u> | | | | | | | | | | | | | | | | | | | | | | | | | | | | | | | | | | | | | | | | | | | | | | | | | | | | | | | | |
| 1 Hz | - | 80 dBc/Hz | | | | | | | | | | | | | | | | | | | | | | | | | | | | | | | | | | | | | | | | | | | | | | | | | | | | | | |
| 10 Hz | - | 100 dBc/Hz | | | | | | | | | | | | | | | | | | | | | | | | | | | | | | | | | | | | | | | | | | | | | | | | | | | | | | |
| 100 Hz | - | 130 dBc/Hz | | | | | | | | | | | | | | | | | | | | | | | | | | | | | | | | | | | | | | | | | | | | | | | | | | | | | | |
| 1 kHz | - | 140 dBc/Hz | | | | | | | | | | | | | | | | | | | | | | | | | | | | | | | | | | | | | | | | | | | | | | | | | | | | | | |
| 10 kHz | - | 150 dBc/Hz | | | | | | | | | | | | | | | | | | | | | | | | | | | | | | | | | | | | | | | | | | | | | | | | | | | | | | |
| <u>LNO180 OCXO-MQ</u> | | | | | | | | | | | | | | | | | | | | | | | | | | | | | | | | | | | | | | | | | | | | | | | | | | | | | | | | |
| 1 Hz | - | 85 dBc/Hz | | | | | | | | | | | | | | | | | | | | | | | | | | | | | | | | | | | | | | | | | | | | | | | | | | | | | | |
| 10 Hz | - | 110 dBc/Hz | | | | | | | | | | | | | | | | | | | | | | | | | | | | | | | | | | | | | | | | | | | | | | | | | | | | | | |
| 100 Hz | - | 135 dBc/Hz | | | | | | | | | | | | | | | | | | | | | | | | | | | | | | | | | | | | | | | | | | | | | | | | | | | | | | |
| 1 kHz | - | 143 dBc/Hz | | | | | | | | | | | | | | | | | | | | | | | | | | | | | | | | | | | | | | | | | | | | | | | | | | | | | | |
| 10 kHz | - | 155 dBc/Hz | | | | | | | | | | | | | | | | | | | | | | | | | | | | | | | | | | | | | | | | | | | | | | | | | | | | | | |
| <u>LNO180 OCXO-HQ</u> | | | | | | | | | | | | | | | | | | | | | | | | | | | | | | | | | | | | | | | | | | | | | | | | | | | | | | | | |
| 1 Hz | - | 93 dBc/Hz | | | | | | | | | | | | | | | | | | | | | | | | | | | | | | | | | | | | | | | | | | | | | | | | | | | | | | |
| 10 Hz | - | 126 dBc/Hz | | | | | | | | | | | | | | | | | | | | | | | | | | | | | | | | | | | | | | | | | | | | | | | | | | | | | | |
| 100 Hz | - | 140 dBc/Hz | | | | | | | | | | | | | | | | | | | | | | | | | | | | | | | | | | | | | | | | | | | | | | | | | | | | | | |
| 1 kHz | - | 145 dBc/Hz | | | | | | | | | | | | | | | | | | | | | | | | | | | | | | | | | | | | | | | | | | | | | | | | | | | | | | |
| 10 kHz | - | 165 dBc/Hz | | | | | | | | | | | | | | | | | | | | | | | | | | | | | | | | | | | | | | | | | | | | | | | | | | | | | | |
| 5 MHz Option: | <table> <tr> <td colspan="3"><u>LNO180/5 OCXO-MQ</u></td> </tr> <tr> <td>1 Hz</td> <td>-</td> <td>88 dBc/Hz</td> </tr> <tr> <td>10 Hz</td> <td>-</td> <td>115 dBc/Hz</td> </tr> <tr> <td>100 Hz</td> <td>-</td> <td>132 dBc/Hz</td> </tr> <tr> <td>1 kHz</td> <td>-</td> <td>145 dBc/Hz</td> </tr> <tr> <td>10 kHz</td> <td>-</td> <td>158 dBc/H</td> </tr> </table> | | <u>LNO180/5 OCXO-MQ</u> | | | 1 Hz | - | 88 dBc/Hz | 10 Hz | - | 115 dBc/Hz | 100 Hz | - | 132 dBc/Hz | 1 kHz | - | 145 dBc/Hz | 10 kHz | - | 158 dBc/H | | | | | | | | | | | | | | | | | | | | | | | | | | | | | | | | | | | | |
| <u>LNO180/5 OCXO-MQ</u> | | | | | | | | | | | | | | | | | | | | | | | | | | | | | | | | | | | | | | | | | | | | | | | | | | | | | | | | |
| 1 Hz | - | 88 dBc/Hz | | | | | | | | | | | | | | | | | | | | | | | | | | | | | | | | | | | | | | | | | | | | | | | | | | | | | | |
| 10 Hz | - | 115 dBc/Hz | | | | | | | | | | | | | | | | | | | | | | | | | | | | | | | | | | | | | | | | | | | | | | | | | | | | | | |
| 100 Hz | - | 132 dBc/Hz | | | | | | | | | | | | | | | | | | | | | | | | | | | | | | | | | | | | | | | | | | | | | | | | | | | | | | |
| 1 kHz | - | 145 dBc/Hz | | | | | | | | | | | | | | | | | | | | | | | | | | | | | | | | | | | | | | | | | | | | | | | | | | | | | | |
| 10 kHz | - | 158 dBc/H | | | | | | | | | | | | | | | | | | | | | | | | | | | | | | | | | | | | | | | | | | | | | | | | | | | | | | |
| Quartz Filter: | Bandwidth 1 kHz | | | | | | | | | | | | | | | | | | | | | | | | | | | | | | | | | | | | | | | | | | | | | | | | | | | | | | | |

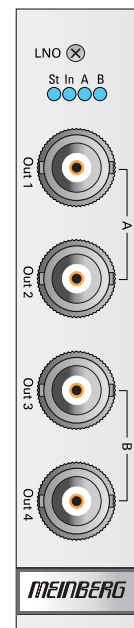

11.5.16 REL1000 - Error Relay Module

The IMS-REL1000 is used as an error relay module that can be used to switch a variety of operating states (e.g. Clock Not Sync, Antenna Faulty, etc.). If the internal hardware clock is running synchronously to the reference source, the relay will switch to NO (Normally Open) mode. In the event of an error, the relay will switch to NC (Normally Closed) mode.

Functionality.

Depending on the IMS system, is redundant with two reference clocks and IMS-RSC module (switching unit) or with one reference clock and SPT module, different relay states can be switched. There is also the possibility to set the relays A + C by different events.

Additional documentation for the REL1000:

The setup guide supports you in a quick initial operation.

<https://www.meinberg.de/download/docs/manuals/english/ims-rel.pdf>

The LANTIME firmware manual provides a complete description of all configurations and status monitoring options of your Meinberg product.

Download LTOS7 Firmware manual:

<http://www.mbg.link/doce-fw-ltos>

11.5.16.1 Error Relay

The illustration on the right shows the two switching states of an error relay.

Technical specification

| | |
|---|---|
| Switching voltage max.: | 220 V DC 250 V AC |
| Switching current max.: | 2 A |
| Switching load max.: | 60 W 62.5 VA |
| FCC surge breakdown voltage between contacts and coil | 1,500 V |
| Max. operating speed (at rated load) | 60 cpm |
| Switching current UL/CSA: | 0.3 A 125 V AC 0.3 A 110 V DC 1 A 30 V DC |
| Response Time: | ca. 3 ms |

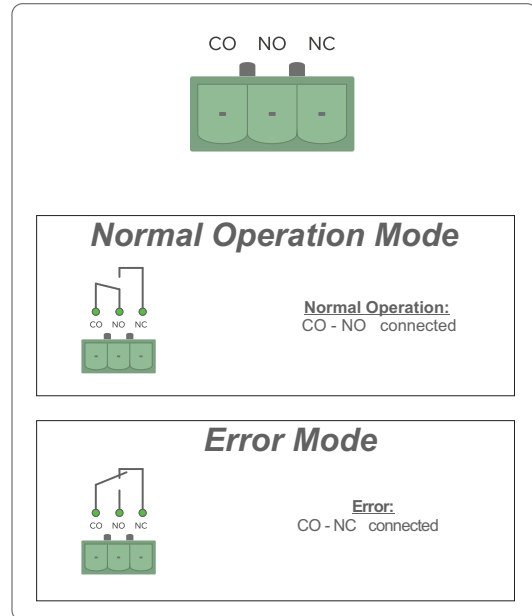

Danger!

This equipment is operated at a hazardous voltage.

Danger of death from electric shock!



- Hazardous voltages may be passing through the terminal of the fault
- Never work with open terminals and plugs while the power is on!
- When handling the connectors of the error relay cable, always disconnect both ends of the cable from their respective devices! signal relay! Never handle the fault signal relay terminal while the signal voltage is present!

11.5.16.2 REL1000 - Status LEDs

Status indicator

LED St: Status of the REL1000
 LED A: Status of Relais A
 LED B: Status of Relais B
 LED C: Status of Relais C

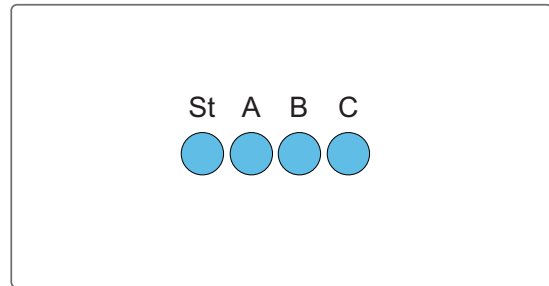

The status messages are as follows:

LED St:

Blue During initialization
 Green During operation

LED A - Status *Relais A*

Initialization: 1 Sek. red -> 1 Sek. yellow -> 1 Sek. green -> 1 Sek off

Green flashing *Normal Operation Mode*
 Red flashing *Error-Mode*

LED B - Status *Relais B*

Initialization: 1 Sek. red -> 1 Sek. yellow -> 1 Sek. green -> 1 Sek off

Green flashing *Normal Operation Mode*
 Red flashing *Error-Mode*

LED C - Status *Relais C*

Initialization: 1 Sek. red -> 1 Sek. yellow -> 1 Sek. green -> 1 Sek off

Green flashing *Normal Operation Mode*
 Red flashing *Error-Mode*

11.5.16.3 Pre-selection

Depending on whether the IMS system is redundantly equipped with RSC module and two reference clocks or with an SPT module with only one reference clock, different relay states can be selected. This must be selected by setting the jumper before installing the REL1000 module.

Jumper setting in redundant operation.

In redundant operation, the jumpers on the REL1000 are set as follows on delivery (see Fig. blue mark). Both clocks and the switchover unit are monitored.

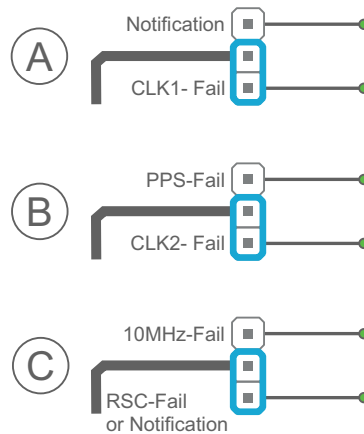

Jumper setting in operation with one reference clock.

If only one reference clock is used, the jumpers of the REL1000 are set as follows on delivery: (Relay A: CLK1-Fail; Relay B: PPS-Fail; Relay C: 10 MHz-Fail). In addition, relays A + C can also be switched by notifications (events).

Possible configurations of the error output:

- Relay A: Clock 1 / event notifications → Relay
- Relay B: Clock 2 / PPS
- Relay C: 10 MHz / RSC or event notifications → Relay

11.5.16.4 REL1000 - Configuration via the Web Interface

The relays A + C of the REL1000 module can be switched via notifications events. If the jumpers and hardware configuration are set accordingly, a checkbox can be activated in the web interface menu "Notification → Notification Events" for various events, so that the selected relay is switched to error mode on this event.

Selectable events are "NTP not Sync" or "Clock not Sync" for example.

| Triggers | | | | | | | | | | | | |
|------------------|----------|--------|-----------|--------------------------|--------------------------|--------------------------|--------------------------|--------------------------|--------------------------|--------------------------|--------------------------|---|
| RELAY IO6 | | | | | | | | | | | | |
| Event | Type | Status | Triggered | EMAIL | SNMP | DISP | USER | ALED | REL1 | REL2 | REL3 | |
| Normal Operation | Info | | 🚨 4d ago | <input type="checkbox"/> | <input type="checkbox"/> | <input type="checkbox"/> | <input type="checkbox"/> | <input type="checkbox"/> | <input type="checkbox"/> | <input type="checkbox"/> | <input type="checkbox"/> | + |
| NTP Not Sync | Error | | | <input type="checkbox"/> | <input type="checkbox"/> | <input type="checkbox"/> | <input type="checkbox"/> | <input type="checkbox"/> | <input type="checkbox"/> | <input type="checkbox"/> | <input type="checkbox"/> | + |
| NTP Sync | Info | | 🚨 4d ago | <input type="checkbox"/> | <input type="checkbox"/> | <input type="checkbox"/> | <input type="checkbox"/> | <input type="checkbox"/> | <input type="checkbox"/> | <input type="checkbox"/> | <input type="checkbox"/> | + |
| NTP Stopped | Critical | | | <input type="checkbox"/> | <input type="checkbox"/> | <input type="checkbox"/> | <input type="checkbox"/> | <input type="checkbox"/> | <input type="checkbox"/> | <input type="checkbox"/> | <input type="checkbox"/> | + |

In this figure there are no selection options - the relays are switched in redundant operation via the reference clocks and the RSC switch unit.

| Triggers | | | | | | | | | | | | |
|------------------|----------|--------|-----------|--------------------------|--------------------------|--------------------------|--------------------------|--------------------------|--------------------------|--------------------------|-------------------------------------|---|
| RELAY IO3 | | | | | | | | | | | | |
| Event | Type | Status | Triggered | EMAIL | SNMP | DISP | USER | ALED | REL1 | REL2 | REL3 | |
| Normal Operation | Info | | 🚨 21d ago | <input type="checkbox"/> | <input type="checkbox"/> | <input type="checkbox"/> | <input type="checkbox"/> | <input type="checkbox"/> | <input type="checkbox"/> | <input type="checkbox"/> | <input type="checkbox"/> | + |
| NTP Not Sync | Error | | | <input type="checkbox"/> | <input type="checkbox"/> | <input type="checkbox"/> | <input type="checkbox"/> | <input type="checkbox"/> | <input type="checkbox"/> | <input type="checkbox"/> | <input checked="" type="checkbox"/> | + |
| NTP Sync | Info | | 🚨 21d ago | <input type="checkbox"/> | <input type="checkbox"/> | <input type="checkbox"/> | <input type="checkbox"/> | <input type="checkbox"/> | <input type="checkbox"/> | <input type="checkbox"/> | <input type="checkbox"/> | + |
| NTP Stopped | Critical | | | <input type="checkbox"/> | <input type="checkbox"/> | <input type="checkbox"/> | <input type="checkbox"/> | <input type="checkbox"/> | <input type="checkbox"/> | <input type="checkbox"/> | <input checked="" type="checkbox"/> | + |

This figure shows the menu in a non-redundant system. Relay C can be controlled via notification events.

11.5.17 FDM - Frequency Deviation Monitoring

The module FDM180 was designed to calculate and monitor the frequency and its deviation in 50/60Hz power line networks.

A preconnected reference is necessary that provides a serial time string and a PPS (pulse per second). The accuracy of the measurements is derived from these signals. The module calculates the frequency as well as the time, based on the mains frequency. The time deviation (TD) is the difference of this calculated time (PLT) to the reference time (REF). This time deviation as well as the frequency itself is sent out via serial interface or is being converted to an analog voltage output provided by a DAC.

Pin Assignment: 16-pin DMC Phoenix Connector

| Pin | Signal |
|----------------|---------------|
| Pin 1 | A0 |
| Pin 2 | A1 |
| Pin 3 | GND |
| Pin 4 | n.c. |
| Pin 5 | n.c. |
| Pin 6 | GND |
| Pin 7 | COM 0 RxD in |
| Pin 8 | COM 0 TxD out |
| Pin 9 - Pin 14 | GND |
| Pin 15 | COM 1 RxD in |
| Pin 16 | COM 1 TxD out |

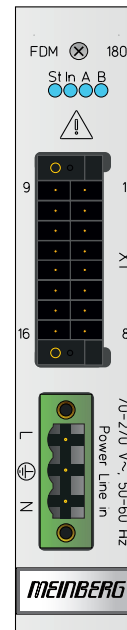

LED Indicator

| | | |
|---------|--------------------------------------|--|
| LED St: | Init | blue during initialisation green - normal operation |
| LED In: | shows the state after initialisation | |
| | red | ref not connected / FDM not sync |
| | yellow | ref. signal not useable |
| | green blinking | Timesync |
| | green | Accurate (≤ 200 ns to reference) |
| LED A: | green | FD (Frequency Deviation) within the configured limits |
| | red | FD Overflow |
| LED B: | green | TD (Time Deviation) within the configured limits |
| | red | TD Overflow |

| | |
|-----------------------------------|---|
| Input signal: | Serial time string, PPS mains frequency, 70 - 270 V AC, 50Hz or 60Hz |
| Interface: | Two asynchronous serial RS-232 ports, COM0 and COM1 Baudrate: 1200, 2400, 4800, 9600, 19200, 38400, 57600, 115200 Baud Framing: 7N2, 7E1, 7E2, 8N1, 8N2, 8E1, 7O2 output and average: once per second or 100ms |
| Output string: | The frequency, frequency deviation, reference time, power line time and the time deviation are send out in different available formats. The formats are: STANDARD FDM String: F:49.984 FD:-00.016 REF:15:03:30 PLT:15:03:30.368 TD:+00.368[CR][LF] SHORT FDM String: FD:-00.016 TD:+00.368[CR][LF] AREVA FDM String: [STX] 02049.984[CR][LF] 021-00.016[CR][LF] 022+00.378[CR][LF] 02315 03 30.368[CR][LF] 024068 15 03 30 [CR][LF] [ETX] |
| Resolution of Measurement: | frequency: accuracy the oscillator (10 MHz) $\pm 100 \mu\text{Hz}$ time deviation: accuracy of reference (PPS) $\pm 1\text{ms}$ |
| Analog outputs: | 2 analog outputs for longtime-recording (time deviation and/or frequency deviation), range: $-2.5\text{ V} \dots +2.5\text{ V}$, resolution: 16 Bit |
| Electrical connectors: | 96-pin VG-rail DIN 41612 |
| Power supply: | +5 V DC |
| Current consumption: | 0.4 A - 1 A |

More detailed information about FDM - Frequency Deviation Monitoring can be found in the current LANTIME firmware manual, chapter "LTOS6 Management and Monitoring → FDM".

11.5.18 SCG-U: Studio Clock Generator

Add-On module for generating various audio frequencies (12 kHz, 32 kHz, 44.1 kHz, 48 kHz, 64 kHz, 88.2 kHz and 96 kHz), with only one 10 MHz input clock, for studio applications. The SCG Module provides four outputs with different frequencies.

The SCG provides a wide range of programmable word clock rates between 24 Hz – 12.288 MHz.

Technical Specifications:

| | |
|-----------------------------|--|
| Outputs: | 4 x BNC (2.5 V TTL into 75 Ohm) outputs with configurable frequencies |
| Input Signal: | 10 MHz, sinewave or square pulse |
| Current Consumption: | 5 V +- 5%, @400 mA |
| Ambient Temperature: | 0 ... 50 °C / 32 ... 122 °F |
| Humidity: | 85% max. |

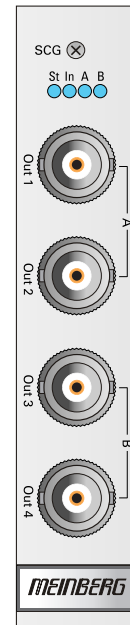

11.5.18.1 SCG-U: Configuration via Web Interface

(Firmware version 6.19 or later)

If the SCG-U operates in an IMS system, the module can be easily configured via the web interface then.

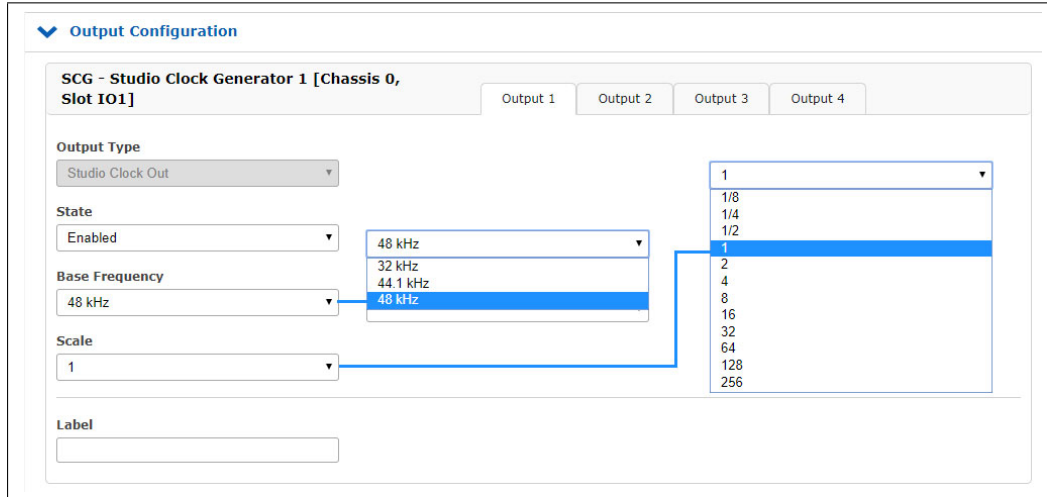

Configuration Sample: SCG Output 3

In the "IO Configuration" menu each output frequency can be adjusted separately. In the figure above the following value is set:

$$\text{Frequency Out 3} = \text{Base Frequency} * \text{Scale}$$

$$\text{Frequency Out 3} = 44,1 \text{ kHz} * 1/4$$

$$\text{Frequency Out 3} = 11,025 \text{ kHz}$$

Overview Configuration SCG-U Sound Clock Generator Outputs 1-4

Output Type: Studio Clock Out

State: Disabled
Enabled

Base Frequency: 32 kHz
44.1 kHz
48 kHz

Scale: 1/8 to 256

11.5.19 SCG-B: Studio Clock Generator Balanced

The M2000S is an additional card for generating "Digital Audio Reference Signals" for studio applications. The 25pin D-Sub female connector provides four DARS outputs, which can be configured via the web interface.

Technical Specifications:

- Outputs:** 1 x 25pin female connector, 4 x DARS, IEC 60958-4 format resolution 24 bits, sampling frequency 48 kHz transformer-balanced
- Input Signals:** 10 MHz (sine wave or square pulse), 1PPS, Time String
- Power Consumption:** 5 V +- 5%, @400 mA
- Environmental Temperature:** 0 ... 50 °C / 32 ... 122 °F
- Humidity:** max. 85%

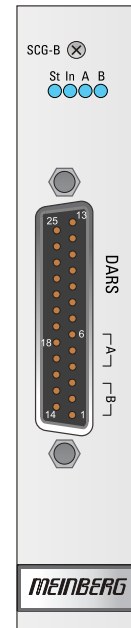

Pin Assignment of the 25pin D-SUB female connector

| | | |
|--------|--------|--------|
| DARS 1 | Hot 1 | Pin 18 |
| | Cold 1 | Pin 6 |
| | GND 1 | Pin 19 |
| DARS 2 | Hot 2 | Pin 4 |
| | Cold 2 | Pin 17 |
| | GND 2 | Pin 5 |
| DARS 3 | Hot 3 | Pin 15 |
| | Cold 3 | Pin 3 |
| | GND 3 | Pin 16 |
| DARS 4 | Hot 4 | Pin 1 |
| | Cold 4 | Pin 14 |
| | GND 4 | Pin 2 |

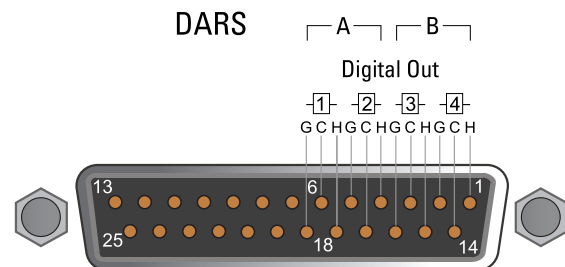

11.5.19.1 SCG-B: Configuration via the Web Interface

If the SCG-B is used in an IMS system you can easily configure the Studio Clock Generator via the Web Interface.

Sample Configuration: Output 1

The screenshot shows a web interface for configuring the Studio Clock Generator. The title is "SCG - Studio Clock Generator 1 [Chassis 0, Slot ES12]". There are four tabs: "Output 1", "Output 2", "Output 3", and "Output 4". The "Output 1" tab is selected. The configuration options are:

- Output Type:** A dropdown menu with "Digital Audio Out" selected.
- Signal Type:** A dropdown menu with "DARS" selected.
- Label:** An empty text input field.

In the menu "IO Configuration" you can set the output on DARS for every output of the M2000S. The four available outputs can optionally be switched off.

11.5.20 VSG - Video Sync Generator

The VSG is a video signal reference for Studio Equipment with four BNC female output connectors. The Module generates 1x bi-level sync (Black Burst), 1x Tri-Level Sync, 1 x video sync signals (H-Sync, V-Sync or LTC) and 1 x digital video output (DARS). The LANTIME Web Interface can be used for output signal configuration and to query the state of the VSG.

Functionality

The board is synchronized by an external 10 MHz signal. It generates configurable video signals in different formats. The generated signals have a phase reference to 1PPS.

Generated Signals:

SMPTE standards: PAL Blackburst with VITC Support
NTSC Blackburst

Tri Level Sync:

720p/50 Hz (SMPTE296M3)
1080i/25 Hz (SMPTE274M6)
720p/59.94 Hz (SMPTE296M1)
1080i/29.97 Hz (SMPTE274M7)

V-, H-, Frame-Sync for HD and SD formats
(VSG FW ≤ 2.05)

LTC (25 fps) (VSG FW ≥ 2.06)

Digital Audio Signal DARS (AES3id via BNC 75 Ω)

Status Info: ST: Status of VSG
In: Status of reference input
A: Status Out 1 + 2
B: Status Out 3 + 4

Electrical Connectors: 96-pin VG-rail DIN 41612

Power Consumption: 5 V \pm 5%, 250 mA

BNC Connectors: 2x BNC female, unbalanced, 300 mV_{pp} @ 75 Ω
2x BNC female, unbalanced, 2.5 V TTL @ 75 Ω

Ambient Temperature: 0 ... 55°C

Humidity: Max. 85%

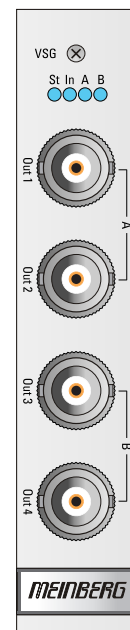

11.5.20.1 VSG Configuration via Web Interface

If the VSG operates in an IMS system, the module can be easily configured via the web interface then.

Overview Configuration VSG Video Sync Generator Outputs 1-4

VSG - Video Signal Generator 1 [Chassis 0, Slot MRI2]

Output 1 Output 2 Output 3 Output 4 Misc

Output Type
Video Out

Epoch
TAI D1970-01-01 T00:00:00

Phase-Offset
0 ns

Label
[Empty]

Format
OFF

1080i 50 Hz
OFF
720p 50 Hz
1080i 50 Hz
720p 59.94 Hz
1080i 59.94 Hz

TAI D1970-01-01 T00:00:00
TAI D1958-01-01 T00:00:00
UTC D1972-01-01 T00:00:00
GPS D1980-01-06 T00:00:00

Output 1

| | |
|---------------|--|
| Output Type: | Video Out |
| Epoch: | TAI D1970-01-01 T00:00:00 UTC D1972-01-01 T00:00:00 GPS D1980-01-06 T00:00:00 |
| Format: | 720p/50 Hz (SMPTE296M3)(HD) 1080i/25 Hz (SMPTE274M6)(HD) 720p/59,94 Hz (SMPTE296M1)(HD) 1080i/29,97 Hz (SMPTE274M7)(HD) |
| Phase Offset: | [Offset Value] |

VSG - Video Signal Generator 1 [Chassis 0, Slot IO4] Output 1 Output 2 Output 3 Output 4 Misc

Output Type
Video Out

Epoch **Format**
TAI D1970-01-01 T00:00:00 PAL (625i)

Phase-Offset
0 ns

Timecode **First Time Code Line**
VITC 19

Time Zone **Second Time Code Line**
(UTC-10) - HST/HDT 21

Use local time offset from PTP TLV if running in PTP slave mode

Label

Output 2:

| | |
|---------------|---------------------------|
| Output Type: | Video Out |
| Epoch: | like Output 1 |
| Format: | NTSC (525i) PAL (625i) |
| Phase Offset: | [Offset Value] |

VSG - Video Signal Generator 1 [Chassis 0, Slot MRI2]

Output 1 Output 2 Output 3 Output 4 Misc

Output Type
LTC Out

Type
OFF

Label

Output 3: (\leq VSG FW 2.05)

Output Type: Video Sync Out

Signal Type: SD H-Sync
SD V-Sync
SD Frame
HD H-Sync
HD V-Sync
HD Frame
HD Blank

Output 3: (VSG FW \geq 2.06 - LTOS V7 required)

Output Type: LTC Out

Signal Type: LTC 25FPS (Frames Per Second)

VSG - Video Signal Generator 1 [Chassis 0, Slot IO4] Output 1 Output 2 Output 3 Output 4 Misc

Output Type

Signal Type

Label

Output 4:

Output Type: Digital Audio Out

Signal Type: DARS (AES3id)

VSG - Video Signal Generator 1 [Chassis 0, Slot IO4] Output 1 Output 2 Output 3 Output 4 Misc

With the menu tab "Misc", the configuration of the VSG can be stored directly in the EEPROM of the card.

11.5.21 VSG181H - Video Sync Generator with D-Sub Output

The VSG181H is used to provide a reference video or audio signal for studio equipment, with generated signals output through two BNC outputs and a 15-pin D-Sub output. The "Black Out" BNC output is used to deliver bi-level ("black & burst") and tri-level sync signals, while the "DARS Out" BNC output provides an unbalanced Digital Audio Receiver Signal (DARS). The D-Sub connector serves as a multi-output solution for several signal types, specifically balanced and unbalanced LTC signals, balanced DARS signals, and word clock signals.

To ensure that the output signals remain highly precise even when switching between clocks using the RSC module (in IMS systems with receiver redundancy), the M2000S may be fitted with a dedicated oscillator.

Features

The VSG181H is synchronized against an external reference frequency (10 MHz), a pulse-per-second signal (PPS), and a time string from an upstream clock. These synchronization signals are essential to maintaining the precision of the output signals. The Web Interface provides a wide range of adjustment and customization options for all output signal types. The signal outputs are phase-matched with the PPS signal.

Black Out Output

| | |
|------------------------|--|
| Output Signal: | NTSC (525i @ 59.94 Hz) <i>"Black & Burst" ITU-R BT.1700/ SMPTE 170M</i> |
| | PAL (625i @ 50 Hz) <i>"Black & Burst", ITU-R BT.1700</i> |
| | 720p @ 50 Hz <i>Tri-Level Sync, SMPTE 296M</i> |
| | 1080i @ 50 Hz <i>Tri-Level Sync, SMPTE 274M</i> |
| | 720p @ 59.94 Hz <i>Tri-Level Sync, SMPTE 296M</i> |
| | 1080i @ 59.94 Hz <i>Tri-Level-Sync, SMPTE 274M</i> |
| | PAL & NTSC signals can include embedded VITC <i>SMPTE 12M-1/SMPTE 309M</i> |
| Signal Level: | 300 mV _{pp} , 75 Ω termination (unbalanced) |
| Connector Type: | BNC Connector, Female |
| Cable: | Coaxial Cable, Shielded |



DARS Output (Unbalanced)

| | |
|------------------------|---|
| Output Signal: | DARS (Unbalanced) |
| Signal Level: | TTL, 2.5 V _{pp} , 75 Ω termination |
| Signal Type: | Digital audio with sample rate of 44.1 kHz or 48 kHz |
| Connector Type: | BNC Connector, Female |
| Cable: | Coaxial Cable, Shielded |

LTC Output (Unbalanced and Balanced)

| | |
|------------------------|--|
| Output Signal: | LTC |
| Signal Level: | <i>Balanced Signal</i> TTL, 2.5 V _{pp} (MARK/SPACE), 600 Ω termination, pin 1 (+) and 2 (-) <i>Unbalanced Signal</i> TTL, 2.5 V _{pp} (MARK/SPACE), 75 Ω termination, pin 15 |
| Formats: | 24 fps (23.976 Hz and 24 Hz) 25 fps 30 fps (with or without drop frame support for adapting 30 fps time code to 29.97 fps content) |
| Connector Type: | D-Sub 15-Pin |

DARS Output (Unbalanced)

| | |
|------------------------|--|
| Output Signal: | DARS (Balanced) |
| Signal Level: | TTL, 2.5 V _{pp} , 110 Ω termination, pin 11 (+) and 12 (-) |
| Signal Type: | Sample frequencies: 44.1 kHz and 48 kHz |
| Connector Type: | D-Sub 15-Pin |

Word Clock Output

| | |
|-------------------------|--|
| Output Signal: | Word Clock |
| Signal Level: | TTL, 2.5 V _{pp} , 75 Ω termination, pin 13 |
| Frequency Range: | 24 Hz – 12.288 MHz |
| Sample Rates: | 44.1 kHz and 48 kHz |
| Scale Factors: | At sample frequency 44.1 kHz - 1/32, 1/16, 1/8, 1/4, 1/2, 1, 2, 4, 8, 16, 32 - Frequency range: 1.378125 kHz to 1.4112 MHz At sample frequency 48 kHz - 1/32, 1/16, 1/8, 1/4, 1/2, 1, 2, 4, 8, 16, 32 - Frequency range: 1.5 kHz to 1.536 MHz |
| Connector Type: | D-Sub 15-Pin |

Status Indicators

| | |
|------------------|------------------------------|
| "St" LED: | Status of the VSG181H |
| "In" LED: | Synchronisation Sstatus |
| "A" LED: | Status of "Black Out" Output |
| "B" LED: | Status of "LTC" Output |

Electrical Specifications

| | |
|-------------------------|-----------------------|
| Power Connector: | 96-Pin DIN 41612 Rail |
| Voltage: | 5 V +- 5 |
| Current Draw: | 250 mA |

11.5.21.1 Configuration and Setup via Web Interface

The screenshot shows the configuration page for 'VSG - Video Signal Generator 2 [Chassis 0, Slot MRI1]'. The 'Output 1' tab is selected. The 'Output Type' is set to 'Video Out'. The 'Epoch' is 'TAI D1970-01-01 T00:00:00'. The 'Format' is 'NTSC (525i)'. The 'Vertical Offset' is '0 Lines' and the 'Horizontal Offset' is '0 ns'. The 'Timecode' is 'None'. The 'First Time Code Line' is '19' and the 'Second Time Code Line' is '21'. The 'Daily Jam Time' is '00 Hours' and '00 minutes'. There is a checkbox for 'Use local time offset from PTP TLV if running in PTP Slave Mode' which is unchecked. A 'Label' field is empty.

Output 1: Black Out

- Output Type: "Video Out" (*Analog Bi-Level-Sync ("Black & Burst") or Tri-Level-Sync Video Signal*)
- Epoch: Video signal timestamp epoch
TAI D1970-01-01 T00:00:00
- Format: "OFF"
 "NTSC (525i)" (*59.94 Hz, "Black & Burst", ITU-R BT.1700/SMPTE ST 170:2004*)
 "PAL (625i)" (*50 Hz, "Black & Burst", ITU-R BT.1700*)
 "720p 50 Hz" (*Tri-Level Sync, SMPTE ST 296*)
 "1080i 50 Hz" (*Tri-Level Sync, SMPTE ST 274*)
 "720p 59.94 Hz" (*Tri-Level Sync, SMPTE ST 296*)
 "1080i 59.94 Hz" (*Tri-Level Sync, SMPTE ST 274*)
- Vertical Offset: Approximate configuration of phase offset in lines
- Horizontal Offset: Fine adjustment of phase offset in 10 ns increments

| | |
|--|---|
| Timecode: | "VITC" "VITC w. daily jam" (<i>NTSC only</i>) "VITC w. daily jam and drop frame" (<i>NTSC only</i>) |
| First Time Code Line: | Select the first line in which the timecode is to be integrated. (6-22) |
| Second Time Code Line: | Select the second line in which the timecode is to be integrated. (6-22) |
| Daily Jam Time: | Define a time for the daily jam event. |
| Use Local Time Offset from PTP TLV if Running in PTP Slave Mode: | If the IMS LANTIME server is being operated as a PTP slave, enabling this option will cause the VSG181H to incorporate any local time offset information included in TLVs from the master clock for generating the signal and time codes. |
| Label: | You can use this field to define a custom label for the output, or you can leave the field blank. |



Output 2 & 4: DARS

| | |
|--------------|---|
| Output Type: | "Digital Audio Out" (<i>Digital Audio Reference Signal [DARS]</i>) |
| Signal Type: | "OFF" "DARS 48 kHz" "DARS 44.1 kHz" |
| Label: | You can use this field to define a custom label for the output, or you can leave the field blank. |

Please note: Output 4 is a "follower" port whose output is solely controlled by the configuration for Output 2 above.

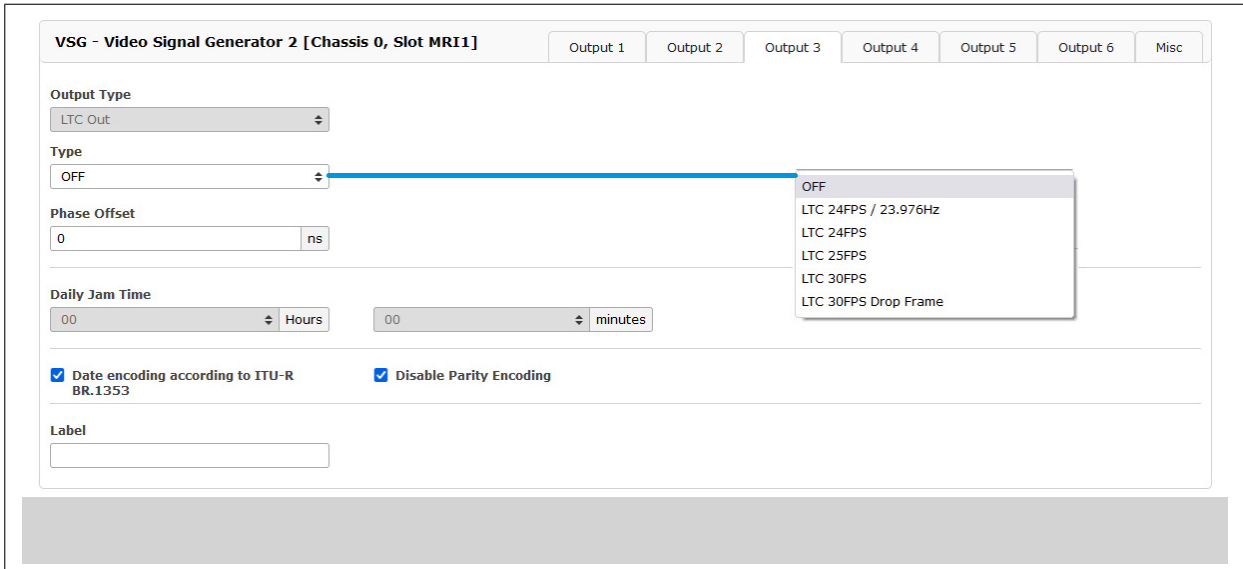

Output 3 & 6: LTC

| | |
|---|---|
| Output Type: | "LTC Out" (<i>Linear Time Code in Audio Signal</i>) |
| Type: | "OFF" "LTC 24 fps / 23.976 Hz" "LTC 24 fps" "LTC 25 fps" "LTC 30 fps" "LTC 30 fps Drop Frame" (<i>for NTSC content with a frame rate of 29.97 fps</i>) |
| Phase Offset: | You can define a phase offset here to compensate for runtime delays. |
| Daily Jam Time: | This is used to set a time for the daily jam event. |
| Date Encoding According to ITU-R BR.1353: | If this option is enabled, the module will format the date information integrated into the LTC data in accordance with the format specified in the ITU recommendation BR.1353. If it is disabled, the data will be formatted in accordance with SMPTE ST 309. A specific setting may be necessary here for compatibility reasons. |
| Disable Parity Encoding: | If this option is enabled, the parity bits will not be integrated into the LTC data. This may be necessary for compatibility reasons. |
| Label: | You can use this field to define a custom label for the output, or you can leave the field blank. |

Please note: Output 6 is a "follower" port whose output is solely controlled by the configuration for Output 3 above.

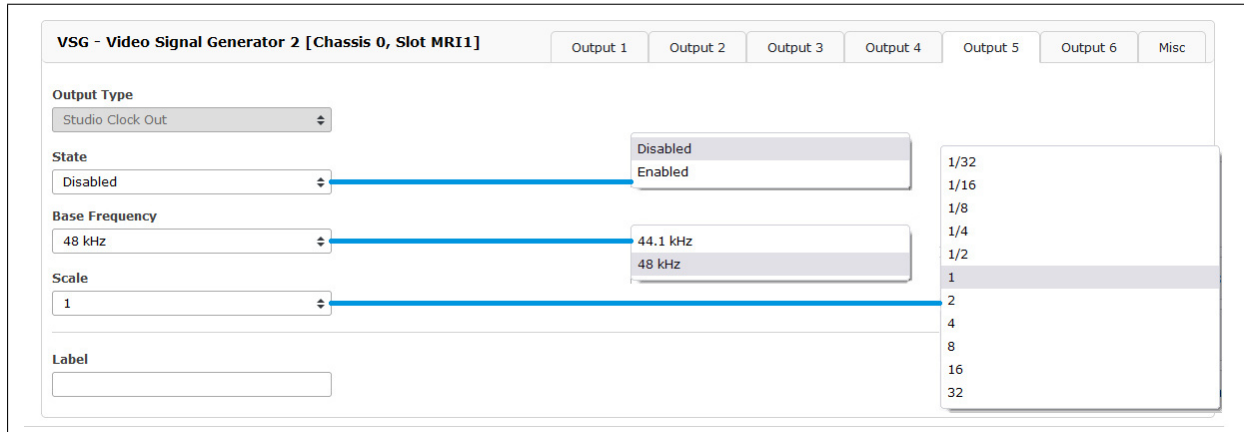

Output 5: Word Clock

Output Type: "Studio Clock Out" (Word Clock)

State: "Disabled"
"Enabled"

Base Frequency: "44.1 kHz"
"48 kHz"

Scale: Used to set the factor by which the base frequency (sampling rate) will be multiplied by. The frequency of the output signal is thus calculated as:

$$\text{Base Sampling Rate} * \text{Scale} = \text{Output Frequency}$$

Label: You can use this field to define a custom label for the output, or you can leave the field blank.



Misc

Time Zone: This can be used to set the time zone of the VSG181H module.

11.5.22 ACM - Active Cooling Module

M2000S ACM Features:

- 2 fans on the plug-in card
- Power consumption per fan: 0.04 A, 5 V DC
- LED status display
- Hot-pluggable

The Active Cooling Module allows the installation of the M2000S safely within the temperature specification. The ACM is easily field-replaceable and allows for a hot-plug replacement without the need to power down the unit.

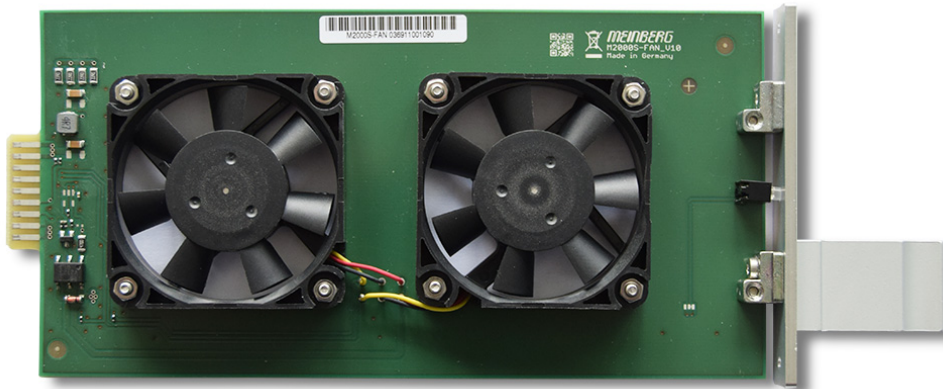

The active cooling and the system temperature can be monitored via the web interface in the menu "System → Fan Control".

Hint:

A safe operation of the LANTIME M2000S can only be guaranteed if the ACM module is running. A short-term failure caused by replacing an ACM module during operation is unavoidable but acceptable.



12 RoHS and WEEE

Compliance with EU Directive 2011/65/EU (RoHS)

We hereby declare that this product is compliant with the European Union Directive 2011/65/EU and its delegated directive 2015/863/EU "Restrictions of Hazardous Substances in Electrical and Electronic Equipment". We ensure that electrical and electronic products sold in the EU do not contain lead, cadmium, mercury, hexavalent chromium, polybrominated biphenyls (PBBs), polybrominated diphenyl ethers (PBDEs), bis(2-ethylhexyl)phthalat (DEHP), benzyl butyl phthalate (BBP), dibutyl phthalate (DBP), or diisobutyl phthalate (DIBP) above the legal limits.



WEEE status of the product

This product is handled as a B2B (Business to Business) category product. To ensure that the product is disposed of in a WEEE-compliant fashion, it must be returned to the manufacturer. Any transportation expenses for returning this product (at end-of-life) must be covered by the end user, while Meinberg will bear the costs for the waste disposal itself.



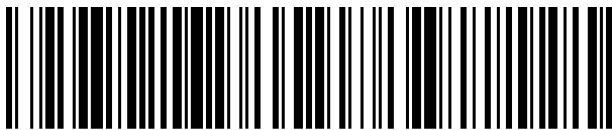

M2000S_QSG_040822