



The Synchronization Experts.



MANUAL

GNS165DHS / GNS165DAHS

DIN Rail GNSS Receiver

19th January 2021

Meinberg Funkuhren GmbH & Co. KG

Table of Contents

1	Imprint	1
2	Safety Hints	2
2.1	Important Safety Instructions and Protective Measures	2
2.2	Used Symbols	3
2.3	Security during Installation	5
2.4	Fuse Replacement	8
2.5	Protective Conductor- / Ground-Terminal	9
2.6	Safety during Operation	9
2.7	Safety during Maintenance	10
2.8	Handling Batteries	10
2.9	Antenna Mounting	11
2.10	Cleaning and Care	11
2.11	Prevention of ESD Damage	12
2.12	Return of Electrical and Electronic Equipment	13
3	Content of the USB Stick	14
4	General information about GNS165	15
5	GNS165 Features	17
5.1	Time Zone and Daylight Saving	17
5.2	Pulse outputs	18
5.3	Asynchronous Serial Ports	18
5.4	Time code outputs	19
5.4.1	Introduction	19
5.4.2	Generated Time Codes	19
5.4.3	Time Code Generation	20
5.4.4	IRIG Standard Format	21
5.4.5	AFNOR Standard Format	22
5.4.6	Assignment of CF Segment in IEEE1344 Code	23
5.5	DCF77 Emulation	24
6	Installation	25
6.1	Technical data GNS165 Chassis	25
6.2	Power supply	25
6.3	40dB Multi GNSS L1 Timing Antenna with Integrated Lightning Protection	26
6.3.1	GNSS Antenna for Stationary Installation	26
6.3.2	GNSS Antenna for Mobile Applications	28
6.4	Powering Up the System	29
6.5	Meinberg Device Manager	30
7	The Front Panel Layout	32
7.1	Front Panel Connectors GNS165	32
7.2	Status LEDs	32
7.3	Assignment of the terminal block	33
7.4	Assignment of the DSUB connectors	34
7.5	GNSS Antenna	35
7.6	DCF77 Simulated Output	36
7.7	Time Code AM Output	36
7.8	Power Supply Connector	37
8	Technical Specifications GNS165 receiver	38
8.1	Connection Data DFMC-connector	40

8.2	Time Strings	41
8.2.1	Format of the Meinberg Standard Time String	41
8.2.2	Format of the SAT Time String	42
8.2.3	Format of the NMEA 0183 String (RMC)	43
8.2.4	Format of the NMEA 0183 String (GGA)	44
8.2.5	Format of the NMEA 0183 String (ZDA)	45
8.2.6	Format of the Uni Erlangen String (NTP)	46
8.2.7	Format of the Computime Time String	48
8.2.8	Format of the SYSPLEX-1 Time String	49
8.2.9	Format of the SPA Time String	50
8.2.10	Format of the RACAL standard Time String	51
8.2.11	Format of the Meinberg GPS Time String	52
8.2.12	Format of the ION Time String	53
8.2.13	Format of the ION Blanked Time String	54
8.2.14	Format of the IRIG J Time String	55
8.3	Oscillator specifications	56
9	RoHS and WEEE	57
10	Declaration of Conformity	58

1 Imprint

Meinberg Funkuhren GmbH & Co. KG
Lange Wand 9, 31812 Bad Pyrmont / Germany

Phone: + 49 (0) 52 81 / 93 09 - 0

Fax: + 49 (0) 52 81 / 93 09 - 230

Internet: <https://www.meinbergglobal.com>

Mail: info@meinberg.de

Date: 19.01.2021

2 Safety Hints

2.1 Important Safety Instructions and Protective Measures

The following safety instructions must be respected in all operating and installation phases of the device. Non-observance of safety instructions, or rather special warnings and operating instructions in product manuals, violates safety standards, manufacturer instructions and proper usage of the device. Meinberg Funkuhren shall not be responsible for any damage arising due to non-observance of these regulations.



Depending on your device or the installed options some information is not valid for your device.



The device satisfies the requirements of the following EU regulations: EMC-Directive, Low Voltage Directive, RoHS Directive and - if applicable - the Radio Equipment Directive.

If a procedure is marked with the following signal words, you may only continue, if you have understood and fulfilled all requirements. In this documentation dangers and indications are classified and illustrated as follows:



DANGER!

The signal word indicates an imminently hazardous situation with a high risk level . This notice draws attention to an operating procedure or similar proceedings, of which a non-observance may result in serious personal injury or death .



WARNING!

The signal word indicates a hazard with a medium risk gradient . This notice draws attention to an operating procedure, a procedure or the like which, if not followed, can lead to serious injuries , possibly resulting in death .



CAUTION!

The signal word indicates a hazard with a low risk gradient . This notice draws attention to an operating procedure, a procedure or the like which, if not followed, can lead to minor injuries .















ATTENTION!

This notice draws attention to an operating procedure, a procedure or the like which, if not followed, can cause damage to the product or loss of important data .

2.2 Used Symbols

The following symbols and pictograms are used in this manual. To illustrate the source of danger, pictograms are used, which can occur in all hazard classes.

Symbol	Beschreibung / Description
	IEC 60417-5031 Gleichstrom / <i>Direct current</i>
	IEC 60417-5032 Wechselstrom / <i>Alternating current</i>
	IEC 60417-5017 Erdungsanschluss / <i>Earth (ground) terminal</i>
	IEC 60417-5019 Schutzleiteranschluss / <i>Protective earth (ground) terminal</i>
	ISO 7000-0434A Vorsicht / <i>Caution</i>
	IEC 60417-6042 Vorsicht, Risiko eines elektrischen Schlages / <i>Caution, risk of electric shock</i>
	IEC 60417-5041 Vorsicht, heiße Oberfläche / <i>Caution, hot surface</i>
	IEC 60417-6056 Vorsicht, Gefährlich sich bewegende Teile / <i>Caution, moving fan blades</i>
	IEC 60417-6172 Trennen Sie alle Netzstecker / <i>Disconnection, all power plugs</i>
	IEC 60417-5134 Elektrostatisch gefährdete Bauteile / <i>Electrostatic Sensitive Devices</i>
	IEC 60417-6222 Information generell / <i>Information general</i>
	2012/19/EU Dieses Produkt fällt unter die B2B Kategorie. Zur Entsorgung muss es an den Hersteller übergeben werden. <i>This product is handled as a B2B category product. In order to secure a WEEE compliant waste disposal it has to be returned to the manufacturer.</i>

The manuals for a product are included in the scope of delivery of the device on a USB stick. The manuals can also be obtained via the Internet. Enter www.meinbergglobal.com into your browser, then enter the corresponding device name in the search field at the top.



This manual contains important safety instructions for the installation and operation of the device. Please read this manual completely before using the unit.

This device may only be used for the purpose described in this manual. In particular, the given limits of the device must be observed. The safety of the installation in which the unit is integrated is the responsibility of the installer!

Non-observance of these instructions can lead to a reduction in the safety of this device!

Please keep this manual in a safe place.

This manual is intended exclusively for electricians or persons trained by an electrician who are familiar with the applicable national standards and safety rules. Installation, commissioning and operation of this device may only be carried out by qualified personnel.

2.3 Security during Installation



WARNING!

Preparing for Commissioning

This built-in unit, has been designed and examined according to the requirements of the standard IEC 62368-1 "Audio/video, information and communication technology equipment - Part 1: Safety requirements".

When the built-in unit is used in a terminal (e.g., housing cabinet), additional requirements according to Standard IEC 62368-1 must be observed and complied with. In particular, the general requirements and the safety of electrical equipment (such as IEC, VDE, DIN, ANSI) as well as the applicable national standards are to be observed.

The device has been developed for use in the industrial sector as well as in residential areas and can only be used in such environments. For environments with higher levels of soiling, additional measures, e.g. Installation in an air-conditioned control cabinet required.

Transport, Unpacking, Installation

If the unit is brought into the operating room from a cold environment, condensation may occur, wait until the unit is temperature-controlled and absolutely dry before operating it.

When unpacking, setting up, and before operating the equipment, be sure to read the information on the hardware installation and the specifications of the equipment. These include, for example, dimensions, electrical characteristics, and necessary ambient and climatic conditions, etc.

The fire protection must be ensured in the installed state.

For mounting, the housing must not be damaged. No holes may be drilled in the housing.

For safety reasons, the device with the highest mass should be installed in the lowest position of the rack. Other devices must be placed from the bottom to the top.

The device must be protected against mechanical stress such as vibration or shock.



Connecting Data Cables

During a thunderstorm, data transmission lines must not be connected or disconnected (risk of lightning).

When wiring the devices, the cables must be connected or disconnected in the order of the arrangement described in the user documentation accompanying the device. Always attach all cables to the plug during connection and removal. Never pull the cable itself. Pulling the cable can cause the cables to disconnect from the plug.

Install the cables in way that they do not constitute a hazard (danger of tripping) and are not damaged, i.e. kinked.

Connecting Power Supply

This equipment is operated at a hazardous voltage. Non-observance of the safety instructions in this manual may result in serious personal injury or property damage.

Before connecting to the power supply, a grounding cable must be connected to the earth connection of the device.

Before operation, check that all cables and lines work properly and are undamaged. Pay particular attention to the facts that the cables do not have kinks or that they are not too short around corners, and no objects are placed on the cables. Also make sure that all connections are secure.

Faulty shielding or cabling will endanger your health (electrical shock) and may destroy other equipment.

Ensure that all necessary safety precautions have been taken. Make all connections to a unit before turning on the power. Observe the safety instructions on the device (see safety symbols).

The metal housing of the device is grounded. It must be ensured that enough air and creepage distances to neighboring voltage-carrying parts are provided during assembly in the control cabinet and no short circuits are caused.

In the case of malfunctions or servicing (e.g. in the event of a damaged housing or power cable or when fluids or foreign objects enter), the current flow can be interrupted. Questions about the house installation, need to be clarified with your house administration.

The power supply should be connected with a short, low-inductance line.

AC Power Supply	DC Power Supply
<ul style="list-style-type: none"> • The device is a device of protection class 1 and may only be connected to a grounded outlet (TN system). • For safe operation, the device must be protected by an installation fuse of max. 16 A and equipped with a residual current circuit breaker in accordance with the applicable national standards. • The unit must always be disconnected from the mains and not from the appliance. • Devices with mains plugs are equipped with a safety-tested mains cable of the country of use and may only be connected to a grounded shockproof socket, otherwise electric shock may occur. • Make sure that the mains socket on the appliance or the mains socket of the house installation is freely accessible to the user so that the mains cable can be pulled out of the socket in case of emergency. 	<ul style="list-style-type: none"> • Outside the assembly group the device must be disconnectable from the power supply in accordance with the provisions of IEC 62368-1 (e.g. by the primary line protection). • Installation and disassembly of the power supply plug is only permitted if the assembly group is switched off (e.g. by the primary line protection). • The supply lines must be adequately secured and dimensioned. <p style="text-align: center;"><i>Connection Cross Section:</i> $1 \text{ mm}^2 - 2.5 \text{ mm}^2$ 17 AWG – 13 AWG</p> <ul style="list-style-type: none"> • The device must be supplied with a suitable disconnecter (switch). The separation device must be easily accessible, placed near the device and marked as a separation device for the unit.

2.4 Fuse Replacement



WARNING!

This equipment is operated at a hazardous voltage.
Danger to life due to electrical shock!



- Disconnect the device from the mains! To do this, press the disconnecter (switch). Then, loosen the locking screws of the supply plug (if present) and pull it off.
- Disconnect all signal lines such as, antenna, fault message relay contact and serial interfaces from the device.
- Replace the fuse.
- Reconnect all cables in reverse order. If necessary, turn on the power again.

Example of fuse marking: T 2.5 A H 250 V

Trigger Characteristic: T (slow)
 Nominal Current A: 2.5 Ampere
 Switching Capacity: H (high)
 max. Voltage: 250 V

AC Power Supply	DC Power Supply
Have the spare fuse ready, pay attention to the correct rated current, characteristics and type. <u>Important:</u> The fuse must be approved for operation at (AC) voltage!	Have the spare fuse ready, pay attention to the correct rated current, characteristics and type. <u>Important:</u> The fuse must be approved for DC operation!
Fuse Type: T <i>Current A / Voltage V</i> in accordance with IEC 60127 with or without extinguishing agent T = Time-lag / SB = SlowBlow	Fuse Type: T <i>Current A / Voltage V</i> in accordance with IEC 60127 with extinguishing agent T = Time-lag / SB = SlowBlow
Dimensions: 5 x 20 mm	Dimensions: 5 x 20 mm

2.5 Protective Conductor- / Ground-Terminal



ATTENTION!



In order to ensure safe operation and to meet the requirements of IEC 62368-1, the device must be correctly connected to the protective earth conductor via the protective earth connection terminal.



If an external earth connection is provided on the housing, it must be connected to the equipotential bonding rail (grounding rail). The mounting parts (without cable) are not included in the scope of delivery.

Note:

Please use a grounding cable $\geq 1.5 \text{ mm}^2$
Always pay attention to a correct crimp connection!

2.6 Safety during Operation



WARNING!

Avoiding Short-Circuits

Make sure not to get any objects or liquids inside the unit. Electric shock or short circuit could result.

Ventilation Slots

Make sure that the ventilation slots are not covered or dusty, as there is a danger of overheating during operation. Disturbances during operation can result.

Normal Operation

The normal operation and the observance of the EMC limits (electromagnetic compatibility) are only ensured if the housing cover is properly installed and when the doors are closed (cooling, fire protection, shielding against electrical, magnetic and electromagnetic fields).



Switch off in fault / service case

By switching off, the devices are not disconnected from the power supply. In the event of a fault or service case, the devices must be immediately disconnected from all power supplies.

Follow the steps below:

- Switch off the device
- Disconnect all power plugs
- Inform the service
- Devices that are connected via one or more uninterruptible power supplies (UPS) remain operational even when the UPS power cord is disconnected. Therefore, you must put the UPS out of operation according to the documentation of the corresponding user documentation.

2.7 Safety during Maintenance



WARNING!

When you are expanding the device, use only device parts that are approved for the system. Non-observance may result in injury to the EMC or safety standards and cause malfunction of the device.

If device parts, which are released for the system, are extended or removed there may be a risk of injury in the area of the hands, due to the pull-out forces (approx. 60 N).

The service informs you which device parts may be installed.

The device must not be opened, repairs to the device may only be carried out by the manufacturer or by authorized personnel. Improper repairs can result in considerable danger to the user (electric shock, fire hazard).

Unauthorized opening of the device or of individual parts of the device can also lead to considerable risks for the user and result in a loss of warranty as well as an exclusion of liability.



- Danger due to moving parts - keep away from moving parts.



- Device parts can become very hot during operation. Do not touch these surfaces! If necessary, switch off the unit before installing or removing any equipment, and allow it to cool down.

2.8 Handling Batteries



CAUTION!

The lithium battery on the receiver modules has a service life of at least 10 years. If an exchange is necessary, the following notes must be observed:

The device is equipped with a lithium battery. The battery must not be short-circuited or recharged. Replacement of the lithium battery may only be carried out by the manufacturer or authorized personnel.

Risk of explosion if the battery is not replaced correctly. Replace only with the same or equivalent type recommended by the manufacturer.

When disposing used batteries, observe the local regulations for the disposal of hazardous waste.

2.9 Antenna Mounting

**WARNING!**

No antenna mounting without effective fall protection.

Risk of death by falling!

- Make sure you that have an effective occupational safety during antenna installation!
- Never work without effective fall protection!

**WARNING!**

Working on the antenna system during thunderstorms.

Danger to life due to electric shock!

- Do not carry out any work on the antenna system or the antenna cable if there is a risk of lightning strikes.
- Do not carry out any work on the antenna system if the safety distance to overhead lines is not guaranteed.

2.10 Cleaning and Care

**ATTENTION!**

Do not wet clean the appliance! Penetrating water can cause considerable dangers to the user (e.g., electric shock).

Liquid can destroy the electronics of the device! Liquid penetrates into the housing of the device and can cause a short circuit of the electronics.

Only clean with a soft, dry cloth. Never use solvents or cleaners.

2.11 Prevention of ESD Damage



ATTENTION!

The designation ESD (Electrostatic Sensitive Devices) refers to measures which are used to protect electrostatically endangered components from electrostatic discharge and thus to prevent destruction. Systems and assemblies with electrostatically endangered components usually have the following characteristics:



Indicator for assemblies with electrostatic endangered components

The following measures protect electrostatically endangered components from destruction:

Prepare removal and installation of assemblies

Unload yourself (for example, by touching a grounded object) before touching assemblies.

Ensure that you wear a grounding strap on the wrist when working with such assemblies, which you attach to an unpainted, non-conductive metal part of the system.

Use only tools and devices that are free from static electricity.

Transporting Assemblies

Assemblies may only be touched at the edge. Do not touch any pins or conductors on assemblies.

Installing and Removing Assemblies

Do not touch persons who are not grounded while removing or installing components. This could result in a loss of grounding protection from your electrostatic discharge.

Storing Assemblies

Always keep assemblies in ESD protective covers. These protective covers must be undamaged. ESD protective covers, which are extremely wrinkled or even have holes, no longer protect against electrostatic discharge.

ESD protective covers must not be low-resistance and metallically conductive if a lithium battery is installed on the assembly.

2.12 Return of Electrical and Electronic Equipment



ATTENTION!

WEEE Directive on Waste Electrical and Electronic Equipment 2012/19 / EU
(WEEE Waste Electrical and Electronic Equipment)

Separate Collection

Product Category: According to the device types listed in the WEEE Directive, Appendix 1, this product is classified as an IT and communication device.



This product meets the labeling requirements of the WEEE Directive. The product symbol on the left indicates that this electronic product must not be disposed of in domestic waste.

Return and Collection Systems

For returning your old equipment, please use the country-specific return and collection systems available to you or contact Meinberg.

The withdrawal may be refused in the case of waste equipment which presents a risk to human health or safety due to contamination during use.

Return of used Batteries

Batteries marked with one of the following symbols may not be disposed of together with the household waste according to the EU Directive.

3 Content of the USB Stick

Besides this manual, the provided USB stick includes a setup program for the monitor software "Meinberg Device Manager". This utility can be used to configure Meinberg receivers via their serial ports and to display status information of the module.



The software is executable under the following operating systems:

- Windows 10
- Windows 8.1
- Windows 8
- Windows 7

- Ubuntu
- Mint Linux
- Debian
- SUSE Linux
- CentOS

If the USB stick is lost, the installation program can be downloaded free of charge from the Internet at: <https://www.meinbergglobal.com/english/sw/mbg-devman.htm>

A detailed documentation in PDF format can be found here: <https://www.meinbergglobal.com/download/docs/manuals/english/meinberg-device-manager.pdf>

4 General information about GNS165

The Meinberg satellite receiver clock of the GNS165 series is available with several options. This manual describes the following models:

	20-60 V DC	100-240 V AC	100-240 V DC	Optocoupler outputs	PhotoMos relay outputs
GNS165DHS	x			x	
GNS165DAHS		x	x	x	
GNS165/AQ/DHS	x				x
GNS165/AQ/DAHS		x	x		x

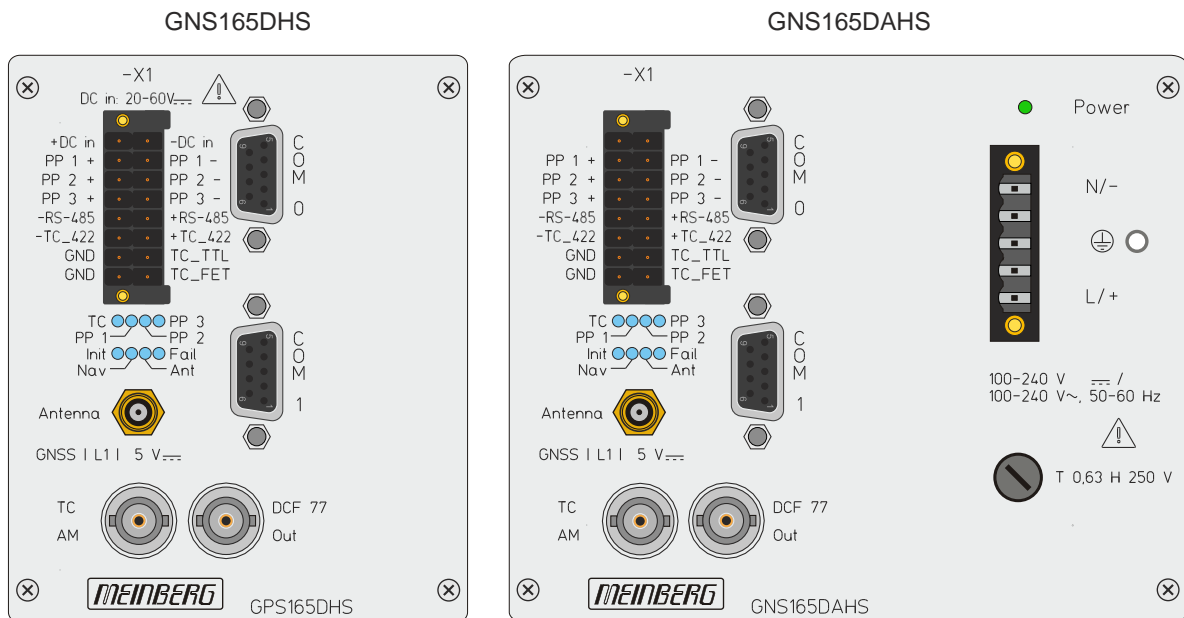

The variants differ in power supply and the type of DC-isolation of the programmable pulse outputs. The differences are described in the relevant chapters, the name GNS165 is used whenever common features of all types of clocks are specified.

The satellite receiver clock GNS165 has been designed to provide an extremely precise time reference for the generation of programmable pulses. High precision available 24 hours a day around the whole world is the main feature of the new system which receives its information from the satellites of the Global Positioning System.

The satellites of most **Global Navigation Satellite Systems (GNSS)** like **GPS**, **GLONASS**, and **Galileo** are not stationary but circle round the globe in periods of several hours. Only few GNSS systems like the Chinese **Beidou** system work with stationary satellites. Such systems can only be received in certain regions of the Earth.

GNSS receivers need to track at least four satellites to determine their own position in space (x, y, z) as well as their time offset from the GNSS system time (t). Only if the receiver can determine its own position accurately the propagation delay of the satellite signals can also be compensated accurately, which is requirement to yield an accurate time. If the receiver position can only be determined less accurately then the accuracy of the derived time is also degraded.

GNSS satellite signals can only be received directly if no building is in the line-of-sight from the antenna to the satellite. The signals can eventually be reflected at buildings, etc., and the reflected signals can then be received. However, in this case the true signal propagation path is longer than expected, which causes a small error in the computed position, which in turn yields less accurate time.

Since most of the satellites are not stationary, the antenna has to be installed in a location with as much clear view of the sky as possible (e.g. on a rooftop) to allow for continuous, reliable reception and operation. Best reception is achieved when the antenna has a free view of 8° angular elevation above the horizon. If this is not possible then the antenna should be installed with the best free view to the sky in direction of the equator. Since the satellite orbits are located between latitudes 55° North and 55° South, this allows for the best possible reception.

All the satellites are monitored by control stations which determine the exact orbit parameters as well as the clock offset of the satellites' on-board atomic clocks. These parameters are uploaded to the satellites and become part of a navigation message which is retransmitted by the satellites in order to pass that information to the user's receiver.

The high precision orbit parameters of a satellite are called ephemeris parameters whereas a reduced precision subset of the ephemeris parameters is called a satellite's almanac. While ephemeris parameters must be evaluated to compute the receiver's position and clock offset, almanac parameters are used to check which satellites are in view from a given receiver position at a given time. Each satellite transmits its own set of ephemeris parameters and almanac parameters of all existing satellites.

5 GNS165 Features

The GNS165 is designed for mounting on a DIN rail. The front panel integrates eight LED indicators, an terminal block, two DSUB, two BNC-connectors and one SMA connector. The receiver is linked to the Multi-GNSS Antenna by a coaxial cable with length up to 70 m (when using Belden H155 low loss cable). It is possible to connect up to four receivers to one antenna by using an optional antenna diplexer. Additional outputs are described below

The navigation message coming from the satellites is decoded by GNS165's microprocessor in order to track the GNSS system time with an accuracy of better than $\pm 100\text{nsec}$. Compensation of the RF signal's propagation delay is done by automatical determination of the receiver's position on the globe. A correction value computed from the satellites' navigation messages increases the accuracy of the board's TCXO to $\pm 5 \times 10^{-9}$ and automatically compensates the oscillators aging. The last recent value is restored from the battery memory at power-up.

5.1 Time Zone and Daylight Saving

GPS system time differs from the universal time scale UTC (Universal Time Coordinated) by the number of leap seconds which have been inserted into the UTC time scale after GPS has been initiated in 1980. The current number of leap seconds is part of the navigation message supplied by the satellites, so GPS170SV's internal real time is based on UTC.

Conversion to local time including handling of daylight saving year by year can be done by the receiver's microprocessor. As standard the switchover times are set to the values of the European Union (Central Europe). The Manual describes how parameter setting for other locations is done. It is possible to deactivate the automatic switching to/from daylight saving.

5.2 Pulse outputs

The pulse generator of the satellite controlled clock GNS165 contains three independent channels and is able to generate a multitude of different pulses, which are configured with the software "Meinberg Device Manager". The active state of each channel is invertible, the pulse duration settable between 10 msec and 10sec in steps of 10 msec. In the default mode of operation the pulse outputs are disabled until the receiver has synchronized after power-up. However, you can configure the assembly group to enable the ports immediately after switching on. The pulse outputs are electrically insulated by optocouplers or PhotoMOS relays and are available at the -X1-Interface (DMC-Connector).

The following modes can be configured for each channel independently:

Timer mode:	Three on- and off-times per day per channel programmable
Cyclic mode:	Generation of periodically repeated pulses. A cycle time of two seconds would generate a pulse at 0:00:00, 0:00:02, 0:00:04 etc.
DCF77-Simulation mode:	The corresponding output simulates the DCF77 time telegram. The time marks are representing the local time as configured by the user.
Single Shot Mode:	A single pulse of programmable length is generated once a day at a programmable point of time
Per Sec. Per Min. Per Hr. modes:	Pulses each second, minute or hour
Status:	One of three status messages can be emitted: 'position OK': The output is switched on if the receiver was able to compute its position 'time sync': The output is switched on if the internal timing is synchronous to the GNS165-system 'all sync': Logical AND of the above status messages. The output is active if position is calculated AND the timing is synchronized
Time code	The un-modulated IRIG or AFNOR signal of the built in time code generator is made available at the respective output.
Idle-mode:	The output is inactive.
Synthesizer:	Frequency output 0 Hz to 10 MHz

5.3 Asynchronous Serial Ports

One RS-485 serial interface and two asynchronous serial interface (RS-232) are available to the user. In the default mode of operation, the serial outputs are disabled until the receiver has synchronized after power up. However, the system can be configured to enable those outputs immediately after power-up. Transmission speeds, framings and the kind of the time string can be configured separately. The serial ports are sending a time string either once per second, once per minute or on request with ASCII "?" only. The format of the output strings is ASCII, see the technical specifications for details. The corresponding parameters can be set up by the program "Meinberg Device Manager" using serial port COM0.

5.4 Time code outputs

5.4.1 Introduction

The transmission of coded timing signals began to take on widespread importance in the early 1950's. Especially the US missile and space programs were the forces behind the development of these time codes, which were used for the correlation of data. The definition of time code formats was completely arbitrary and left to the individual ideas of each design engineer. Hundreds of different time codes were formed, some of which were standardized by the "Inter Range Instrumentation Group" (IRIG) in the early 60's. Detailed information about IRIG and other time codes can be found on

<http://www.meinberg.de/english/info/irig.htm>

Except these time codes other formats, like NASA36, XR3 or 2137, are still in use. The module however generates IRIG-B or AFNOR NFS500 only.

Selection of the generated time code is done by using the monitor program.

5.4.2 Generated Time Codes

Besides the amplitude modulated sine wave signal, the board also provides unmodulated DC-Level Shift TTL output in parallel. Thus six time codes are available.

- | | |
|--------------|---|
| a) B002: | 100 pps, DCLS signal, no carrier
BCD time-of-year |
| b) B122: | 100 pps, AM sine wave signal, 1 kHz carrier frequency
BCD time-of-year |
| c) B003: | 100 pps, DCLS signal, no carrier
BCD time-of-year, SBS time-of-day |
| d) B123: | 100 pps, AM sine wave signal, 1 kHz carrier frequency
BCD time-of-year, SBS time-of-day |
| e) B006: | 100 pps, DCLS Signal, no carrier
BCD time-of-year, Year |
| f) B126: | 100 pps, AM sine wave signal, 1 kHz carrier frequency
BCD time-of-year, Year |
| g) B007: | 100 pps, DCLS Signal, no carrier
BCD time-of-year, Year, SBS time-of-day |
| h) B127: | 100 pps, AM sine wave signal, 1 kHz carrier frequency
BCD time-of-year, Year, SBS time-of-day |
| i) AFNOR: | Code according to NFS-87500, 100 pps, wave signal,
1kHz carrier frequency, BCD time-of-year, complete date,
SBS time-of-day, Signal level according to NFS-87500 |
| j) IEEE1344: | Code according to IEEE1344-1995, 100 pps, AM sine wave signal,
1kHz carrier frequency, BCD time-of-year, SBS time-of-day,
IEEE1344 extensions for date, timezone, daylight saving and
leap second in control functions (CF) segment.
(also see table 'Assignment of CF segment in IEEE1344 mode') |
| k) C37.118 | Like IEEE1344 - with turned sign bit for UTC-Offset |

5.4.3 Time Code Generation

In the default mode of operation the IRIG/AFNOR timecode outputs are disabled until the GNS-receiver has been synchronized after power-up. Due to that the generation of the IRIG-code only starts after synchronization.

If the code must be available immediately after power-up, the software "Meinberg Device Manager" can be used to enable the time code output without synchronization of the GNS-receiver by setting the enable flag 'pulses' to 'always'. In this mode of operation the IRIG-code is not locked to UTC-second until synchronization.

5.4.4 IRIG Standard Format

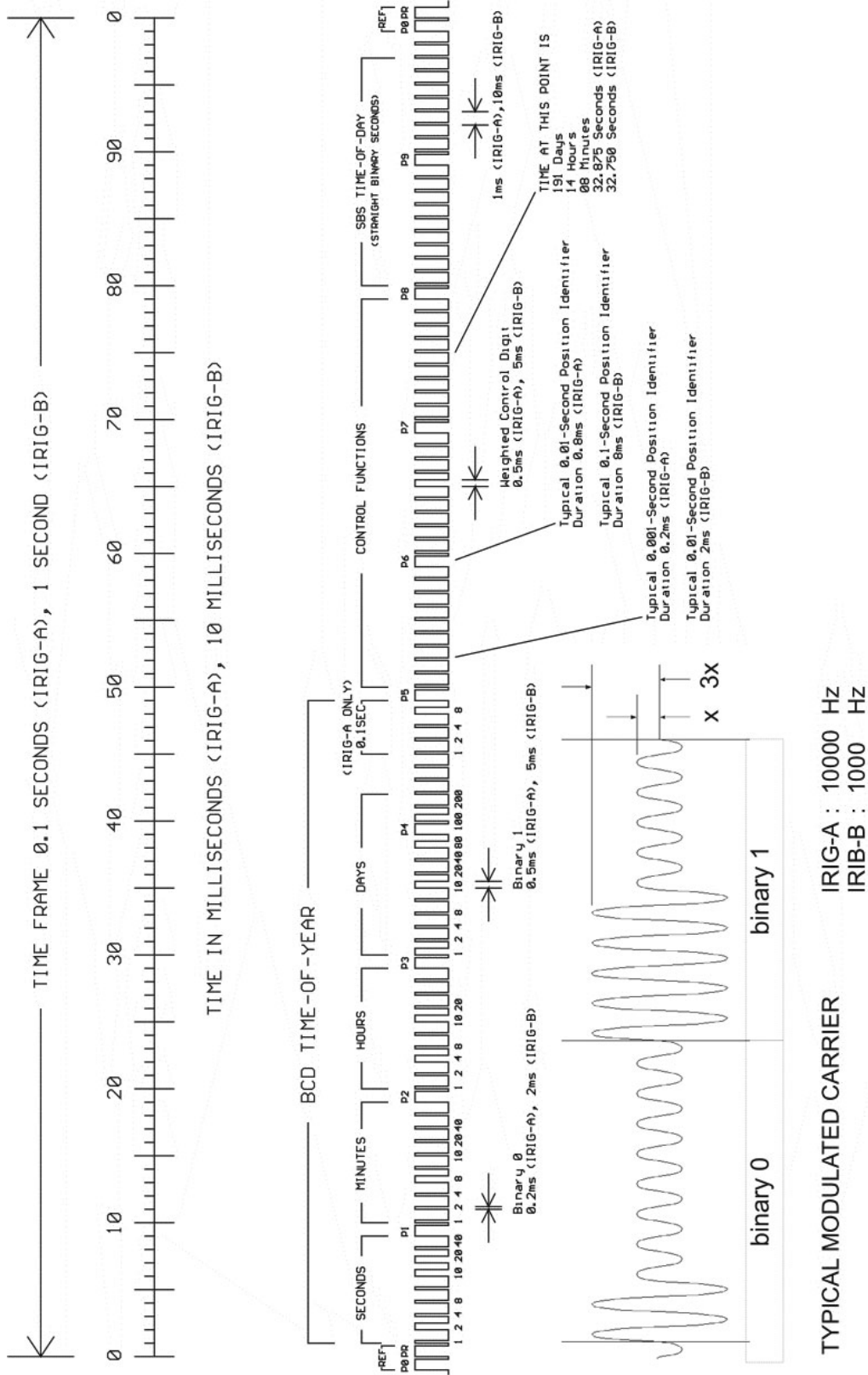

5.4.5 AFNOR Standard Format

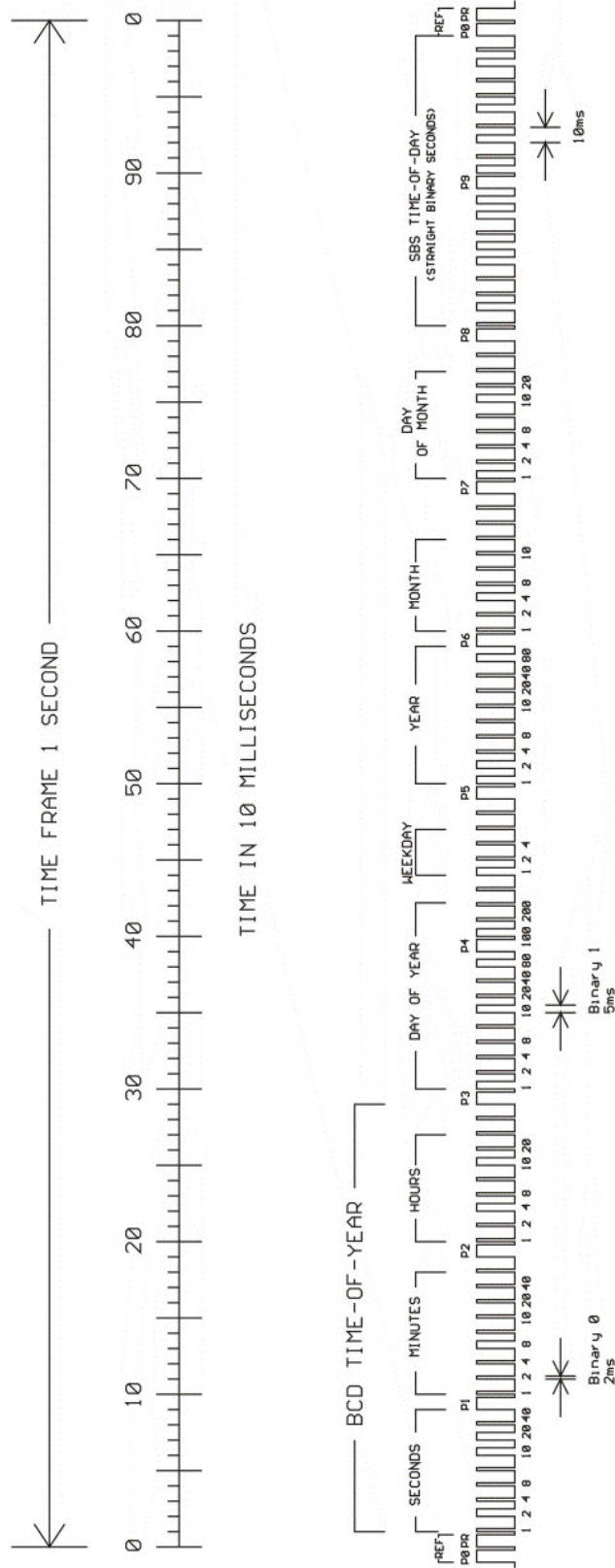

5.4.6 Assignment of CF Segment in IEEE1344 Code

Bit No.	Designation	Description
49	Position Identifier P5	
50	Year BCD encoded 1	
51	Year BCD encoded 2	low nibble of BCD encoded year
52	Year BCD encoded 4	
53	Year BCD encoded 8	
54	empty, always zero	
55	Year BCD encoded 10	
56	Year BCD encoded 20	high nibble of BCD encoded year
57	Year BCD encoded 40	
58	Year BCD encoded 80	
59	Position Identifier P6	
60	LSP - Leap Second Pending	set up to 59s before LS insertion
61	LS - Leap Second	0 = add leap second, 1 = delete leap second ¹⁾
62	DSP - Daylight Saving Pending	set up to 59s before daylight saving changeover
63	DST - Daylight Saving Time	set during daylight saving time
64	Timezone Offset Sign	sign of TZ offset 0 = '+', 1 = '-'
65	TZ Offset binary encoded 1	
66	TZ Offset binary encoded 2	Offset from IRIG time to UTC time.
67	TZ Offset binary encoded 4	Encoded IRIG time plus TZ Offset equals UTC at all times!
68	TZ Offset binary encoded 8	
69	Position Identifier P7	
70	TZ Offset 0.5 hour	set if additional half hour offset
71	TFOM Time figure of merit	
72	TFOM Time figure of merit	time figure of merit represents approximated clock error. ²⁾
73	TFOM Time figure of merit	0x00 = clock locked, 0x0F = clock failed
74	TFOM Time figure of merit	
75	PARITY	parity on all preceding bits incl. IRIG-B time

- 1.) current firmware does not support leap deletion of leap seconds
 2.) TFOM is cleared, when clock is synchronized first after power up. see chapter Selection of generated timecode

5.5 DCF77 Emulation

The clock generates TTL level time marks (active HIGH) which are compatible with the time marks spread by the German long wave transmitter DCF77. This long wave transmitter installed in Mainflingen near Frankfurt/Germany transmits the reference time of the Federal Republic of Germany: time of day, date of month and day of week in BCD coded second pulses. Once every minute the complete time information is transmitted. However, the generates time marks representing its local time as configured by the user, including announcement of changes in daylight saving and announcement of leap seconds. The coding scheme is given below:

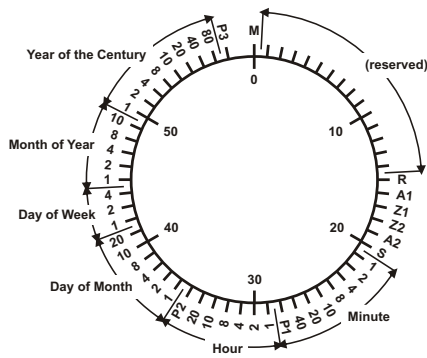

M	Start of Minute (0.1 s)
R	RF Transmission via secondary antenna
A1	Announcement of a change in daylight saving
Z1, Z2	Time zone identification
	Z1, Z2 = 0, 1: Daylight saving disabled
	Z1, Z2 = 1, 0: Daylight saving enabled
A2	Announcement of a leap second
S	Start of time code information
P1, P2, P3	Even parity bits

Time marks start at the beginning of new second. If a binary "0" is to be transmitted, the length of the corresponding time mark is 100 msec, if a binary "1" is transmitted, the time mark has a length of 200 msec. The information on the current date and time as well as some parity and status bits can be decoded from the time marks of the 15th up to the 58th second every minute. The absence of any time mark at the 59th second of a minute signals that a new minute will begin with the next time mark. The DCF emulation output is enabled immediately after power-up. The time stamps can be provided via pulses outputs. Furthermore, the DCF77 signal is available via a BNC connector as an amplitude-modulated 77.5 kHz carrier. This output can be used for radio clocks as a replacement for a DCF77 antenna.

6 Installation

6.1 Technical data GNS165 Chassis

The variants of the module GNS165 are designed for following housing dimensions of DIN-railmount:

Housing:	GPS165DHS:	85 mm x 105 mm x 104 mm	(B x H x T)
	GPS165DAHS:	125.5 mm x 105 mm x 104 mm	(B x H x T)
	GPS165DAHSx	165.5 mm x 105 mm x 104 mm	(B x H x T)
Ambient Temperature:		0...50 °C	
Storage Temperature:		-20...70 °C	
Humidity:		85 %	
Protecting Rate:		IP20	

6.2 Power supply

The variants of the module GNS165 are designed for following power supply options:

GNS165DHS:	20-60 V DC (DC-insulation 1.5 kV DC)
GNS165DAHS:	100-240 V DC 100-240 V AC, 50-60 Hz

The voltage feed of the DC variants is done via terminal blocks in the frontpanel of the clock and should have low resistance to minimize spurious emission (EMI).

To avoid potential differences between the signal ground of GNS165 and a post-connected unit installed on different DIN rails, the signal ground of the clock is insulated from the case.

The case must be grounded by using the rear contact.

6.3 40dB Multi GNSS L1 Timing Antenna with Integrated Lightning Protection

The GPS, GLONASS, Galileo and BeiDou satellites are not stationary but circle round the globe in a period of about 12 hours. They can only be received if no building is in the line-of-sight from the antenna to the satellite, so the antenna unit must be installed in a location with a free view to the sky. The best reception is given when the antenna has a free view of 8° angular elevation above horizon. If this is not possible the antenna should be installed with a mostly free view to the equator because of the satellite courses which are located between latitudes of 55° North and 55° South. If even this is not possible problems occur especially when at least four satellites for positioning have to be found.

The active L1 timing reference antenna is specifically designed for long-lasting, trouble-free deployments for a variety of applications. The low noise, high gain amplifier is well suited to address attenuation issues. The proprietary quadrifilar helix design, coupled with multistage filtering provides superior out-of-band rejection and lower elevation pattern performance than traditional patch antennas.

- Their unique radome shape sheds water and ice, while eliminating problems associated with bird perching.
- This antenna is made of materials that fully comply with provisions stipulated by EU directives RoHS 2002/95/EC.
- The antenna provides integrated lightning protection capability.
- The antenna also features ESD, reverse polarity protection and transit voltage suppression.

A standard coaxial cable with 50 ohm impedance should be used to connect the antenna to the receiver. The max. length of cable between antenna and receiver is 50 meters (H155 - Low-Loss).

See data sheet "40 dB Multi GNSS Timing Antenna with Integrated Lightning Protection" (pctel_gpsl1gl.pdf) or download this document:

[Active Multi GNSS Antenna](#)

http://www.meinbergglobal.com/download/docs/other/pctel_gpsl1gl.pdf

6.3.1 GNSS Antenna for Stationary Installation

The **Multi GNSS Antenna** is an active GNSS antenna which can receive the signals of the GPS, GLONASS, Galileo and Beidou satellite systems. It is very well suited for stationary installations, operates with a 5V DC supply voltage provided by the receiver, and has an integrated surge protection.

The antenna cable length can be up to 70 meters if a H155 low-loss coaxial cable is used.

Mounting and Installation of the GNSS/L1 Antenna

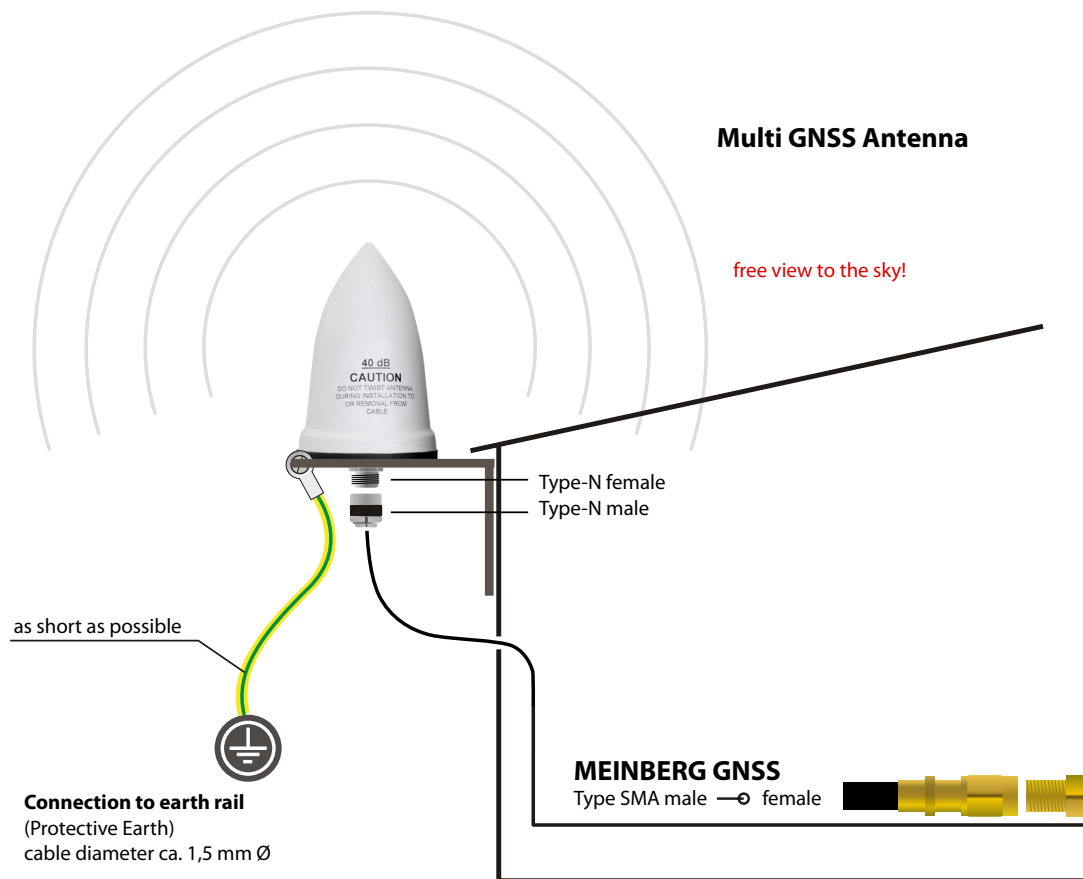





Figure: Schematic diagram of mounting the Multi GNSS Antenna

 **WARNING!**
Antenna mounting without effective anti-fall protection

Danger to life due to fall!

- Pay attention to effective working safety when installing antennas!
- Never work without an effective anti-fall equipment!

 **WARNING!**
Working on the antenna system during thunderstorms

 **Danger to life due to electrical shock!**

- Do not carry out any work on the antenna system or the antenna cable if there is a risk of a lightning strike.
- Do not carry out any work on the antenna system if the safety distance to free lines and sequential circuits is exceeded.

6.3.2 GNSS Antenna for Mobile Applications

The RV-76G is an active GNSS antenna which can receive the signals of the GPS, GLONASS, and Galileo satellite systems. It operates with a 5V DC supply voltage provided by the receiver, and should be preferred for mobile applications. However, the maximum length of the antenna cable is limited depending on the cable type, e.g. 5 meters with RG174/U cable, so this antenna is less suitable for stationary installations.

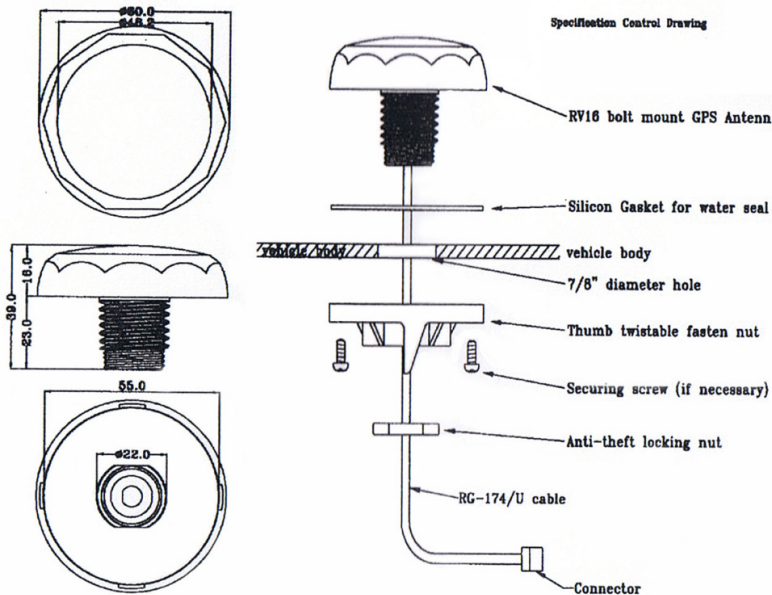

Figure: Installation drawing RV-76G antenna



WARNING!

Antenna mounting without effective anti-fall protection

Danger to life due to fall!

- Pay attention to effective working safety when installing antennas!
- Never work without an effective anti-fall equipment!



WARNING!

Working on the antenna system during thunderstorms

Danger to life due to electrical shock!

- Do not carry out any work on the antenna system or the antenna cable if there is a risk of a lightning strike.
- Do not carry out any work on the antenna system if the safety distance to free lines and sequential circuits is exceeded.



6.4 Powering Up the System

If both the antenna and the power supply have been connected the system is ready to operate. About 10 seconds to 3 minutes after power-up the receiver has warmed up and operates with the required accuracy. If the receiver finds valid almanac and ephemeris data in its battery buffered memory and the receiver's position has not changed significantly since its last operation the receiver can find out which satellites are in view now. Only a single satellite needs to be received to synchronize and generate output pulses, so synchronization can be achieved maximally one to 10 minutes after power-up. After 20 minutes of operation the OCXO is full adjusted and the generated frequencies are within the specified tolerances.

If the receiver position has changed by some hundred kilometers since last operation, the satellites' real elevation and doppler might not match those values expected by the receiver thus forcing the receiver to start scanning for satellites. This mode is called Warm Boot because the receiver can obtain ID numbers of existing satellites from the valid almanac. When the receiver has found four satellites in view it can update its new position and switch to Normal Operation. If the almanac has been lost because the battery had been disconnected the receiver has to scan for a satellite and read in the current almanacs. This mode is called Cold Boot. It takes 12 minutes until the new almanac is complete and the system switches to Warm Boot mode scanning for other satellites.

In the default mode of operation, neither pulse and synthesizer outputs nor the serial ports will be enabled after power-up until synchronization has been achieved. However, it is possible to configure some or all of those outputs to be enabled immediately after power-up. If the system starts up in a new environment (e. g. receiver position has changed or new power supply) it can take some minutes until the OCXO's output frequency has been adjusted. Up to that time accuracy of frequency drops to 10^{-8} reducing the accuracy of pulses to $\pm 3 \mu\text{s}$.

6.5 Meinberg Device Manager

The program serves the configuration of Meinberg Radio Clocks. The software can be run on the operating systems Windows 7 or higher.

Documentation:

<https://www.meinbergglobal.com/download/docs/manuals/english/meinberg-device-manager.pdf>

Download:

<https://www.meinbergglobal.com/english/sw/mbg-devman.htm>

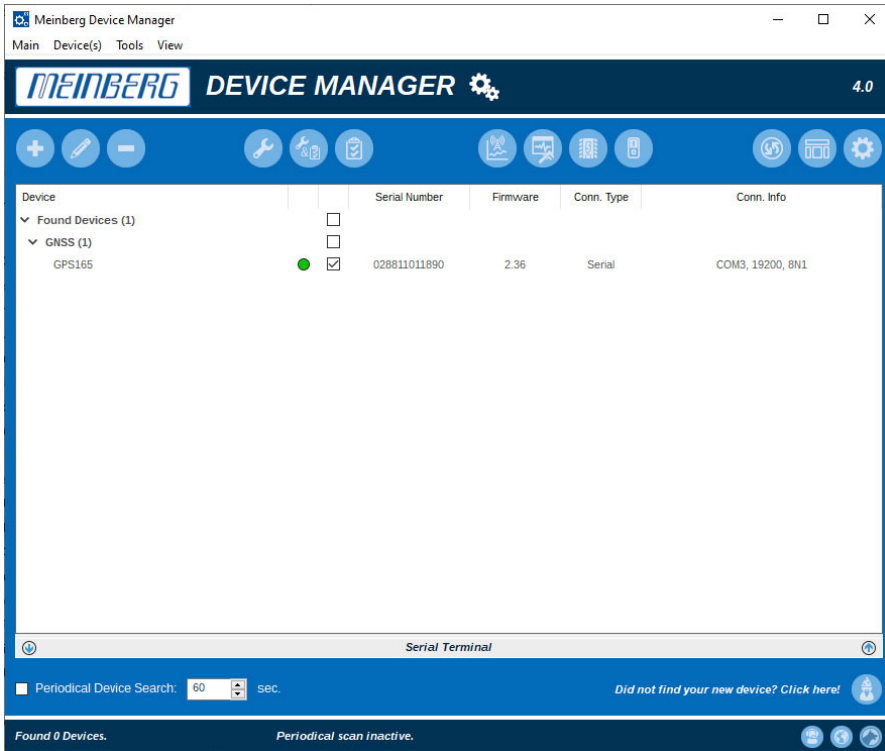

A connection between the system and the program can be produced by serial port. The configurations are described in the "Meinberg Device Manager" documentation.

Connection

The PC should have generated an automatic connection to the clock, select the tab "Search Device". Alternatively, you can use the button "Add Device" to generate a connection to the clock by using the same configure (Port / Baud / Framing).

Configuration

SVNO	Elevation	Azimuth	Doppler	Status
5	50°	214°	-2088 Hz	OK
7	30°	65°	-2755 Hz	OK
8	12°	44°	331 Hz	OK
13	62°	291°	1597 Hz	OK
15	29°	293°	3071 Hz	OK
21	11°	319°	-96 Hz	OK
28	45°	141°	1926 Hz	OK
30	63°	71°	-1418 Hz	OK

With "Configure Device" various configurations can be carried out on the system. Please note that any changes you make in the settings must always be confirmed with the "Apply Configuration" button. Use the "Restore Configuration" button to reset all settings back to their default values. For more information, please refer to the Meinberg Device Manager manual.

7 The Front Panel Layout

7.1 Front Panel Connectors GNS165

Name	Type	Signal	Cable
COM 0, COM 1 COM 2	9pin D-SUB 16pin Terminal	RS-232 RS-485	shielded data line data line
Optoc. Out	16pin Terminal		
DCF Out	BNC female	77.5 kHz	shielded coaxial line
Time Code AM Out	BNC female	3 V _{pp} into 50 Ω	shielded coaxial line
DCLS Out	16pin Terminal	RS-422, TTL	data line
Antenna	SMA	L1 5 V	shielded coaxial line
Power supply	over 16pin Terminal (DHS standard model) over 5pin Screwterminal (AHS, DAHS)		

7.2 Status LEDs

LED Indicators

- TC: green: if time code RS422 is available
- PP 1 - PP 3: green: if a programmable pulse is available
- Init: blue: while the receiver passes through the initialization phase
green: the oscillator has warmed up
- Fail: red: time has not synchronized
- Ant: red: antenna faulty or not connected
- Nav: green: positioning successfully

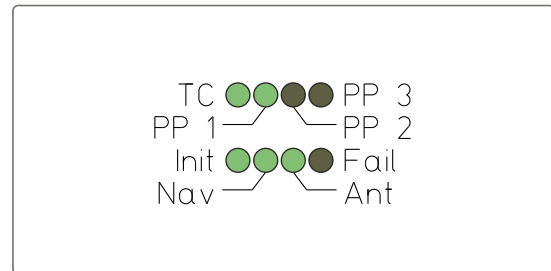

7.3 Assignment of the terminal block

The pulse outputs are accessible through the terminal block in the front panel. In addition, the power supply of variants GNS165DHS and GNS165/AQ/DHS is connected using two poles of this terminal block. The marking besides the terminal has the following meaning:

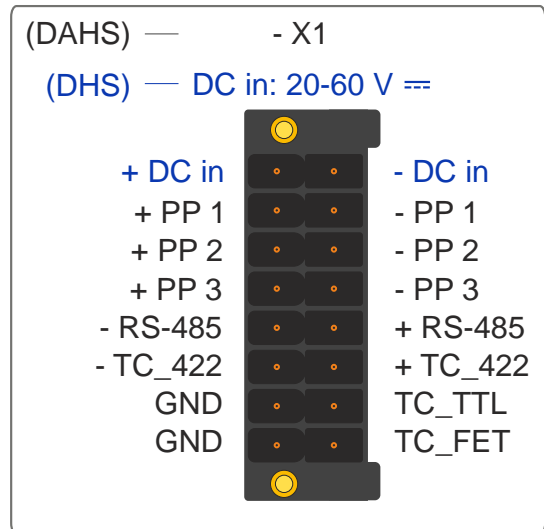

+ DC in	positive potential of power supply (GNS165(/AQ/)DHS only)
- DC in	reference potential of power supply (nur GNS165(/AQ/)DHS)
+ PP x	Programmable Pulse (positiv)
- PP x	Programmable Pulse (negativ)
+ RS-485	Serial Time string (positiv)
- RS-485	Serial Time string (negativ)
+ TC_422	Time Code (DCLS) with RS-422 level (positiv)
- TC_422	Time Code (DCLS) with RS-422 level (negativ)
TC_TTL	Time Code (DCLS), TTL into 50 Ω
TC_FET	Time Code (DCLS), field-effect transistor (470 Ω to +5V)
GND	Ground

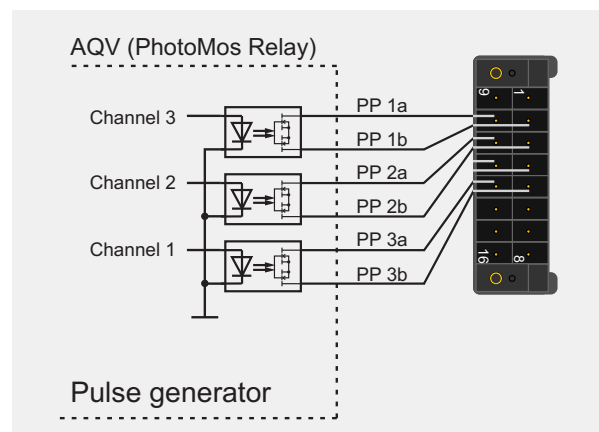
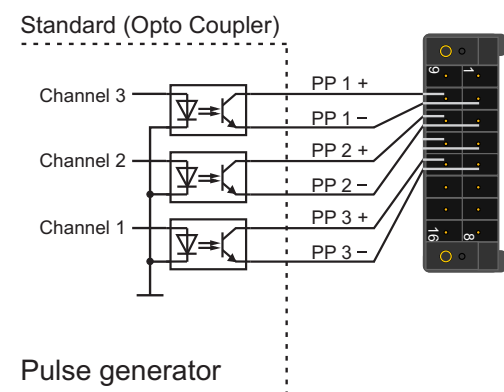

7.4 Assignment of the DSUB connectors

The serial ports COM 0 and COM 1 are accessible via 9pin DSUB connectors in the frontpanel. These RS-232 interfaces can be connected to a computer by using a standard modem cable. TxD describes the sending, RxD the receiving line of the GNS165.

Connector: D-SUB female 9pin

Cable: shielded data line

Assignment:

Pin 2: TxD (transmit)

Pin 3: RxD (receive)

Pin 5: GND (ground)

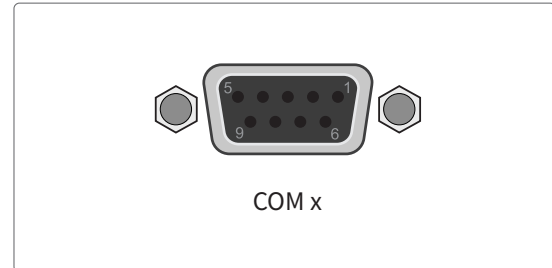

7.5 GNSS Antenna

Antenna type	Multi GNSS L1 antenna with integrated lightning protection
Receiver type	72-channel GPS/Galileo/Glonass/Beidou
Frequency band	L1 / E1 / B1 , 1575.42 +- 10 MHz / 1602-1615 MHz
Signal gain	40 dB
Antenna gain:	≥ 3.5 dBic / ≥ 3 dBic
DC Voltage:	5 V (power supply via antenna cable)
DC Current:	max. 100 mA
Nominal impedance:	50 Ω
Connection type:	SMA female
Cable:	shielded coaxial line
Cable length:	deductible up to max. 70 m with Belden H155 coaxial cable

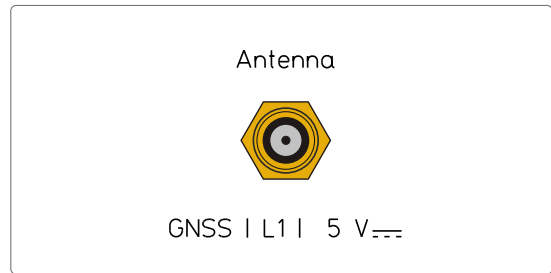

WARNING!

Working on the antenna system during thunderstorms



Danger to life due to electrical shock!

- Do not carry out any work on the antenna system or the antenna cable if there is a risk of a lightning strike.
- Do not carry out any work on the antenna system if the safety distance to free lines and sequential circuits is exceeded.

7.6 DCF77 Simulated Output

Output signal:	77,5 kHz frequency
Signal level:	-62 dBm
Connection type:	BNC, female
Cable:	shielded coax line

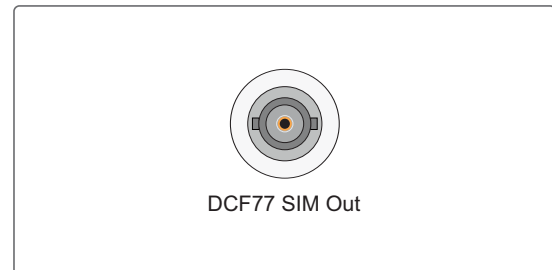

7.7 Time Code AM Output

Carrier frequency:	1 kHz (IRIG-B)
Signal outputs:	Unbalanced sine wave-signal: 3 V _{pp} (MARK) 1 V _{pp} (SPACE) into 50 Ohm
Connector:	BNC, female
Cable:	shielded coax line



7.8 Power Supply Connector

Connection Type:	5pin DFK
Pin Assignment:	1: N/- 2: not connected 3: PE (Protective Earth) 4: not connected 5: L/+

Input Parameter

Nominal Voltage Range: $U_N = 100-240\text{ V}\sim$
 $100-240\text{ V}\equiv$

Max. Voltage Range: $U_{\max} = 85-264\text{ V}\sim$
 $90-264\text{ V}\equiv$

Nominal Current: $I_N = 0.15\text{ A}$

Nominal Frequency Range: $f_N = 50-60\text{ Hz}$

Max. Frequency Range: $f_{\max} = 47-63\text{ Hz}$

Inrush Current: $I_P = 50\text{ A @ }230\text{ V AC}$

Output Parameter

Max. Power: $P_{\max} = 15\text{ W}$

Max. Heat Emission: $E_{\text{therm}} = 54.00\text{ kJ/h (51.19 BTU/h)}$

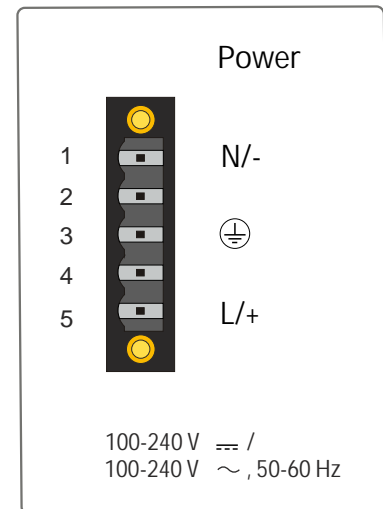

WARNING!

This equipment is operated at a hazardous voltage.



Danger to life due to electrical shock!

- Only qualified personnel (electricians) may connect the device.
- Never work with open terminals and plugs while the power is on.
- All connectors must be protected against touching live parts with a suitable plug housing!
- Note: Always ensure safe wiring!
- Important: The device must be connected to a proper grounding (PE).

8 Technical Specifications GNS165 receiver

Receiver:	Combined GPS / GLONASS / Galileo / BeiDou receiver Number of channels: 72 Frequency band: GNSS L1 1575.42 +- 10 MHz / 1602-1615 MHz
Antenna:	Type of antenna: Multi – GNSS L1 Antenna Antenna with Integrated Lightning Protection (see chapter "Mounting the antenna")
Time to Synchronization:	one minute with known receiver position and valid almanac 12 minutes if invalid battery buffered memory
Battery Backup:	storage of pulse configuration and important GNSS-system data in the internal RAM, backed-up by lithium battery lifetime of battery 10 years min.
Pulse Outputs:	three programmable outputs GNS165/DHS, GNS165/DAHS DC-insulated by optocouplers $U_{CEmax} = 55 \text{ V}$, $I_{Cmax} = 50 \text{ mA}$, $P_{tot} = 150 \text{ mW}$, $V_{iso} = 5000 \text{ V}$ pulse delay: t_{on} e.g. $20 \mu\text{sec}$ ($I_C = 10 \text{ mA}$) t_{off} e.g. $3 \mu\text{sec}$ ($I_C = 10\text{mA}$) GNS165/AQ/DHS, GNS165/AQ/DAHS DC-insulated by PhotoMOS relays $U_{max} = 250 \text{ V AC/DC peak}$, $I_{max} = 150 \text{ mA}$, $P_{tot} = 360 \text{ mW}$, $V_{iso} = 1500 \text{ V}$ pulse delay: t_{on} e.g. $0,18 \text{ msec}$ ($I_{load} = 150 \text{ mA}$) t_{off} e.g. $0,07 \text{ msec}$ ($I_{load} = 150\text{mA}$) default settings: all pulse outputs inactive mode of operation: 'if sync'
Accuracy of Pulses:	better than +-100nsec after synchronization and 20 minutes of operation better than +-3 μsec during the first 20 minutes of operation
Serial Ports:	3 independant asynchronous serial ports COM0 (RS-232) Baud Rate: 300 up to 19200 Framing: 7N2, 7E1, 7E2, 8N1, 8N2, 8E1, 801 COM1 (RS-232, optional RS-485) Baud Rate: 300 up to 19200 Framing: 7N2, 7E1, 7E2, 8N1, 8N2, 8E1, 801 COM2 (RS-485) Baud Rate: 300 up to 19200 Framing: 7N2, 7E1, 7E2, 8N1, 8N2, 8E1, 801 time string selectable for COM0, COM1 and COM2 possible stringtypes in chapter: Time Stings

	default settings:	COM0: 19200, 8N1 COM1, COM2: 9600, 8N1 'standard Meinberg' time string per second mode of operation 'if sync'
Time Code		
Outputs:	modulated via BNC-connector: 3 V _{pp} (MARK), 1 V _{pp} (SPACE) into 50Ω	
	unmodulated via 16-pin terminal: Field effect transistor with internal pull-up (1 kΩ) to +5 V	
	Data of transistor: U _{Smax} = 100 V, I _{dmax} = 150 mA, P _{max} = 250 mW	
	TTL into 50Ω RS422	
DCF77-Emulation:	AM-modulated 77.5 kHz carrier frequency usable as replacement for a DCF77 antenna output level approximately -55 dBm (unmodulated)	
Power Requirements:	GNS165/DHS 20-60 V DC DC-isolation 1.5 kV DC	
	GNS165/DAHS 100-240 V DC 100-240 V AC, 50-60 Hz Fuse: 630 mA	
Dimension:	GNS165/DHS 105 mm x 85 mm x 104 mm (height x width x depth)	
	GNS165/DAHS 105 mm x 125.5 mm x 104 mm (height x width x depth)	
Connectors:	SMA connector for Multi-GNSS connection, AM modulated DCF77 output and modulated time code output 16-pole terminal block for connection of: - pulse outputs - power supply (GNS165DHS and GNS165/AQ/DHS only)	
	DAHS, AQ/DAHS: 5pol. Screwterminal	
Ambient Temperature:	0 ... 50°C	
Humidity:	85% max.	

8.1 Connection Data DFMC-connector

Conductor cross section solid min.	0.2 mm ²
Conductor cross section solid max.	1.5 mm ²
Conductor cross section flexibel min.	0.2 mm ²
Conductor cross section flexibel max.	1.5 mm ²
Conductor cross section flexible, with ferrule, without plastic sleeve min.	0.25 mm ²
Conductor cross section flexible, with ferrule, without plastic sleeve max.	1.5 mm ²
Conductor cross section flexible, with ferrule, with plastic sleeve min.	0.25 mm ²
Conductor cross section flexible with ferrule, with plastic sleeve max.	0.75 mm ²
Conductor cross section AWG min.	24
Conductor cross section AWG max.	16
AWG according to UL/CUL min.	16
AWG according to UL/CUL max.	24

Specifications for ferrules

Ferrules without insulating collar,
according to DIN 46228-1

Cross-section: 0.25 mm² ; length: 5 mm ... 7 mm
 Cross-section: 0.34 mm² ; length: 7 mm
 Cross-section: 0.5 mm² ; length: 8 mm ... 10 mm
 Cross-section: 0.75 mm² ; length: 8 mm ... 10 mm
 Cross-section: 1 mm² ; length: 8 mm ... 10 mm
 Cross-section: 1.5 mm² ; length: 10 mm

Ferrules with insulating collar,
according to DIN 46228-4

Cross-section: 0.14 mm² ; length: 8 mm
 Cross-section: 0.25 mm² ; length: 8 mm ... 10 mm
 Cross-section: 0.34 mm² ; length: 8 mm ... 10 mm
 Cross-section: 0.5 mm² ; length: 8 mm ... 10 mm
 Cross-section: 0,75 mm² ; length: 8 mm ... 10 mm

8.2 Time Strings

8.2.1 Format of the Meinberg Standard Time String

The Meinberg Standard Time String is a sequence of 32 ASCII characters starting with the STX (start-of-text) character and ending with the ETX (end-of-text) character. The format is:

<STX>*D:dd.mm.yy;T:w;U:hh.mm.ss;uvxy*<ETX>

The letters printed in italics are replaced by ASCII numbers whereas the other characters are part of the time string. The groups of characters as defined below:

<STX>	Start-Of-Text, ASCII Code 02h sending with one bit accuracy at change of second
dd.mm.yy	the current date: dd day of month (01..31) mm month (01..12) yy year of the century (00..99)
w	the day of the week (1..7, 1 = Monday)
hh.mm.ss	the current time: hh hours (00..23) mm minutes (00..59) ss seconds (00..59, or 60 while leap second)
uv	clock status characters (depending on clock type):
u:	'#' GPS: clock is running free (without exact synchr.) PZF: time frame not synchronized DCF77: clock has not synchronized after reset ' ' (space, 20h) GPS: clock is synchronous (base accuracy is reached) PZF: time frame is synchronized DCF77: clock has synchronized after reset
v:	'*' GPS: receiver has not checked its position PZF/DCF77: clock currently runs on XTAL ' ' (space, 20h) GPS: receiver has determined its position PZF/DCF77: clock is synchronized with transmitter
x	time zone indicator: 'U' UTC Universal Time Coordinated, formerly GMT ' ' CET European Standard Time, daylight saving disabled 'S' (CEST) European Summertime, daylight saving enabled
y	announcement of discontinuity of time, enabled during last hour before discontinuity comes in effect: '!' announcement of start or end of daylight saving time 'A' announcement of leap second insertion ' ' (space, 20h) nothing announced
<ETX>	End-Of-Text, ASCII Code 03h

8.2.2 Format of the SAT Time String

The SAT Time String is a sequence of 29 ASCII characters starting with the STX (start-of-text) character and ending with the ETX (end-of-text) character. The format is:

`<STX>dd.mm.yy/w/hh:mm:ssxxxuv<ETX>`

The letters printed in italics are replaced by ASCII numbers whereas the other characters are part of the time string. The groups of characters as defined below:

<code><STX></code>	Start-Of-Text, ASCII Code 02h sending with one bit accuracy at change of second
<code>dd.mm.yy</code>	the current date:
dd	day of month (01..31)
mm	month (01..12)
yy	year of the century (00..99)
w	the day of the week (1..7, 1 = Monday)
<code>hh:mm:ss</code>	the current time:
hh	hours (00..23)
mm	minutes (00..59)
ss	seconds (00..59, or 60 while leap second)
<code>xxxx</code>	time zone indicator:
'UTC'	Universal Time Coordinated, formerly GMT
'CET'	European Standard Time, daylight saving disabled
'CEST'	European Summertime, daylight saving enabled
<code>u</code>	clock status characters:
'#'	clock has not synchronized after reset
' '	(space, 20h) clock has synchronized after reset
<code>v</code>	announcement of discontinuity of time, enabled during last hour before discontinuity comes in effect:
'!'	announcement of start or end of daylight saving time
' '	(space, 20h) nothing announced
<code><CR></code>	Carriage Return, ASCII Code 0Dh
<code><LF></code>	Line Feed, ASCII Code 0Ah
<code><ETX></code>	End-Of-Text, ASCII Code 03h

8.2.3 Format of the NMEA 0183 String (RMC)

The NMEA String is a sequence of 65 ASCII characters starting with the '\$GPRMC' character and ending with the characters CR (carriage return) and LF (line-feed). The format is:

```
$GPRMC,hhmmss.ss,A,bbbb.bb,n,llll.ll,e,0.0,0.0,ddmmyy,0.0,a*hh<CR><LF>
```

The letters printed in italics are replaced by ASCII numbers or letters where as the other characters are part of the time string. The groups of characters as defined below:

\$	Start character, ASCII Code 24h sending with one bit accuracy at change of second
hhmmss.ss	the current time: hh hours (00..23) mm minutes (00..59) ss seconds (00..59, or 60 while leap second) ss seconds (1/10 ; 1/100)
A	Status (A = time data valid, V = time data not valid)
bbbb.bb	latitude of receiver position in degrees leading signs are replaced by a space character (20h)
n	latitude, the following characters are possible: 'N' north of equator 'S' south d. equator
llll.ll	longitude of receiver position in degrees leading signs are replaced by a space character (20h)
e	longitude, the following characters are possible: 'E' east of Greenwich 'W' west of Greenwich
0.0,0.0	Speed over the ground in knots and track angle in degrees, with a Meinberg GPS clock these values are always 0.0, in case of a GNS clock the values will be calculated by the receiver in mobile applications
ddmmyy	the current date: dd day of month (01..31) mm month (01..12) yy year of the century (00..99)
a	magnetic variation
hh	checksum (EXOR over all characters except '\$' and '*')
<CR>	Carriage Return, ASCII Code 0Dh
<LF>	Line Feed, ASCII Code 0Ah

8.2.4 Format of the NMEA 0183 String (GGA)

The NMEA (GGA) String is a sequence of characters starting with the '\$GPRMC' character and ending with the characters CR (carriage return) and LF (line-feed). The format is:

\$GPGGA,*hhmmss.ss,bbbb.bbbbb,n,llll.ll,e,A,vv,hhh.h,aaa.a,M,ggg.g,M,,0cs<CR><LF>**

The letters printed in italics are replaced by ASCII numbers or letters where as the other characters are part of the time string. The groups of characters as defined below:

\$	Start character, ASCII Code 24h sending with one bit accuracy at change of second
hhmmss.ss	the current time: hh hours (00..23) mm minutes (00..59) ss seconds (00..59, or 60 while leap second) ss fractions of seconds (1/10 ; 1/100)
A	Status (A = time data valid) (V = time data not valid)
bbbb.bbbbb	latitude of receiver position in degrees leading signs are replaced by a space character (20h)
n	latitude, the following characters are possible: 'N' north of equator 'S' south d. equator
llll.lllll	longitude of receiver position in degrees leading signs are replaced by a space character (20h)
e	longitude, the following characters are possible: 'E' east of Greenwich 'W' west of Greenwich
A	Position fix (1 = yes, 0 = no)
vv	Satellites used (0..12)
hhh.h	HDOP (Horizontal Dilution of Precision)
aaa.h	Mean Sea Level altitude (MSL = altitude of WGS84 - Geoid Separation)
M	Units, meters (fixed value)
ggg.g	Geoid Separation (altitude of WGS84 - MSL)
M	Units, meters (fixed value)
cs	checksum (EXOR over all characters except '\$' and '*')
<CR>	Carriage Return, ASCII Code 0Dh
<LF>	Line Feed, ASCII Code 0Ah

8.2.5 Format of the NMEA 0183 String (ZDA)

The NMEA String is a sequence of 38 ASCII characters starting with the '\$GPZDA' character and ending with the characters CR (carriage return) and LF (line-feed). The format is:

\$GPZDA, *hhmmss.ss, dd, mm, yyyy, HH, IIcs<CR><LF>**

ZDA - Time and Date: UTC, day, month, year and local timezone.

The letters printed in italics are replaced by ASCII numbers or letters where as the other characters are part of the time string. The groups of characters as defined below:

\$ Start character, ASCII Code 24h
sending with one bit accuracy at change of second

hhmmss.ss the current UTC time:
 hh hours (00..23)
 mm minutes (00..59)
 ss seconds (00..59 or 60 while leap second)

HH,II the local timezone (offset to UTC):
 HH hours (00..±13)
 II minutes (00..59)

dd,mm,yy the current date:
 dd day of month (01..31)
 mm month (01..12)
 yyyy year (0000..9999)

cs checksum (EXOR over all characters except '\$' and '*')

<CR> Carriage Return, ASCII Code 0Dh

<LF> Line Feed, ASCII Code 0Ah

8.2.6 Format of the Uni Erlangen String (NTP)

The time string Uni Erlangen (NTP) of a GPS clock is a sequence of 66 ASCII characters starting with the STX (start-of-text) character and ending with the ETX (end-of-text) character. The format is:

<STX>tt.mm.jj; w; hh:mm:ss; voo:oo; acdfg i;bbb.bbbbn ll.Lllle hhhhm<ETX>

The letters printed in italics are replaced by ASCII numbers whereas the other characters are part of the time string. The groups of characters as defined below:

<i><STX></i>	Start-Of-Text, ASCII Code 02h sending with one bit accuracy at change of second
<i>dd.mm.yy</i>	the current date:
<i>dd</i>	day of month (01..31)
<i>mm</i>	month (01..12)
<i>yy</i>	year of the century (00..99)
<i>w</i>	the day of the week (1..7, 1 = Monday)
<i>hh.mm.ss</i>	the current time:
<i>hh</i>	hours (00..23)
<i>mm</i>	minutes (00..59)
<i>ss</i>	seconds (00..59, or 60 while leap second)
<i>v</i>	sign of the offset of local timezone related to UTC
<i>oo:oo</i>	offset of local timezone related to UTC in hours and minutes
<i>ac</i>	clock status characters:
<i>a:</i>	'#' clock has not synchronized after reset
	' ' (space, 20h) clock has synchronized after reset
<i>c:</i>	'*' GPS receiver has not checked its position
	' ' (space, 20h) GPS receiver has determined its position
<i>d</i>	time zone indicator:
	'S' CEST European Summertime, daylight saving enabled
	' ' CET European Standard Time, daylight saving disabled
<i>f</i>	announcement of discontinuity of time, enabled during last hour before discontinuity comes in effect:
	'!' announcement of start or end of daylight saving time
	' ' (space, 20h) nothing announced
<i>g</i>	announcement of discontinuity of time, enabled during last hour before discontinuity comes in effect:
	'A' announcement of leap second insertion
	' ' (space, 20h) nothing announced
<i>i</i>	leap second insertion
	'L' leap second is actually inserted (active only in 60th sec.)
	' ' (space, 20h) no leap second is inserted
<i>bbb.bbbb</i>	latitude of receiver position in degrees leading signs are replaced by a space character (20h)
<i>n</i>	latitude, the following characters are possible:
	'N' north of equator

	'S'	south d. equator
lll.llll		longitude of receiver position in degrees leading signs are replaced by a space character (20h)
e		longitude, the following characters are possible: 'E' east of Greenwich 'W' west of Greenwich
hhhh		altitude above WGS84 ellipsoid in meters leading signs are replaced by a space character (20h)
<ETX>		End-Of-Text, ASCII Code 03h

8.2.7 Format of the Computime Time String

The Computime time string is a sequence of 24 ASCII characters starting with the T character and ending with the LF (line feed, ASCII Code 0Ah) character. The format is:

T:yy:mm:dd:ww:hh:mm:ss<CR><LF>

The letters printed in italics are replaced by ASCII numbers whereas the other characters are part of the time string. The groups of characters as defined below:

T	Start character sending with one bit accuracy at change of second
yy:mm:dd	the current date: yy year of the century (00..99) mm month (01..12) dd day of month (01..31) ww the day of the week (01..07, 01 = monday)
hh:mm:ss	the current time: hh hours (00..23) mm minutes (00..59) ss seconds (00..59, or 60 while leap second)
<CR>	Carriage Return, ASCII Code 0Dh
<LF>	Line Feed, ASCII Code 0Ah

8.2.8 Format of the SYSPLEX-1 Time String

The SYSPLEX1 time string is a sequence of 16 ASCII characters starting with the SOH (Start of Header) ASCII control character and ending with the LF (line feed, ASCII Code 0Ah) character.

Please note:

To receive the Timestring on a selected terminal correctly you have to send a " C " (once, without quotation marks).

The format is:

`<SOH>ddd:hh:mm:ssq<CR><LF>`

The letters printed in italics are replaced by ASCII numbers whereas the other characters are part of the time string. The groups of characters as defined below:

<code><SOH></code>	Start of Header (ASCII control character) sending with one bit accuracy at change of second
<code>ddd</code>	day of year (001..366)
<code>hh:mm:ss</code>	the current time:
hh	hours (00..23)
mm	minutes (00..59)
ss	seconds (00..59, or 60 while leap second)
q	Quality indicator
	(space) Time Sync (GPS lock)
	(?) no Time Sync (GPS fail)
<code><CR></code>	Carriage-return (ASCII code 0Dh)
<code><LF></code>	Line-Feed (ASCII code 0Ah)

8.2.9 Format of the SPA Time String

The ABB SPA Time String is a sequence of 32 ASCII characters starting with the characters ">900WD" and ending with the <CR> (Carriage Return) character. The format is:

>900WD:*jj-mm-tt_hh.mm;ss.fff*:cc<CR>

The letters printed in italics are replaced by ASCII numbers whereas the other characters are part of the time string. The groups of characters as defined below:

jj-mm-tt	the current date:		
	jj	year of the century	(00..99)
	mm	month	(01..12)
	tt	day of month	(01..31)
	–	Space	(ASCII-code 20h)
hh.mm;ss.fff	the current time:		
	hh	hours	(00..23)
	mm	minutes	(00..59)
	ss	seconds	(00..59, or 60 while leap second)
	fff	milliseconds	(000..999)
cc	Checksum. EXCLUSIVE-OR result of the previous characters, displayed as a HEX byte (2 ASCII characters 0..9 or A..F)		
<CR>	Carriage Return		ASCII Code 0Dh

8.2.10 Format of the RACAL standard Time String

The RACAL standard Time String is a sequence of 16 ASCII characters terminated by a X (58h) character and ending with the CR (Carriage Return, ASCII Code 0Dh) character. The format is:

<X><G><U>*yymmddhhmmss*<CR>

The letters printed in italics are replaced by ASCII numbers whereas the other characters are part of the time string. The groups of characters as defined below:

<X>	Control character sending with one bit accuracy at change of second	code 58h
<G>	Control character	code 47h
<U>	Control character	code 55h
yymmdd	the current date:	
	yy year of the century	(00..99)
	mm month	(01..12)
	dd day of month	(01..31)
hh:mm:ss	the current time:	
	hh hours	(00..23)
	mm minutes	(00..59)
	ss seconds	(00..59, or 60 while leap second)
<CR>	Carriage Return, ASCII code 0Dh	

8.2.11 Format of the Meinberg GPS Time String

The Meinberg Standard Time String is a sequence of 36 ASCII characters starting with the STX (start-of-text) character and ending with the ETX (end-of-text) character. Contrary to the Meinberg Standard Telegram the Meinberg GPS Timestrings carries no local timezone or UTC but the direct GPS time without conversion into UTC. The format is:

<STX>D:*tt.mm.jj*;T:w;U:*hh.mm.ss*;uvGy;lll<ETX>

The letters printed in *italics* are replaced by ASCII numbers whereas the other characters are part of the time string. The groups of characters as defined below:

<STX>	Start-Of-Text (ASCII code 02h)
<i>tt.mm.jj</i>	the current date: <i>tt</i> day of month (01..31) <i>mm</i> month (01..12) <i>jj</i> year of the century (00..99)
w	the day of the week (1..7, 1 = monday)
<i>hh.mm.ss</i>	the current time: <i>hh</i> hours (00..23) <i>mm</i> minutes (00..59) <i>ss</i> seconds (00..59, or 60 while leap second)
uv	clock status characters: u: '#' clock is running free (without exact synchr.) ' ' (space, 20h) clock is synchronous (base accuracy is reached) v: '*' receiver has not checked its position ' ' (space, 20h) receiver has determined its position
G	time zone indicator 'GPS-Time'
y	announcement of discontinuity of time, enabled during last hour before discontinuity comes in effect: 'A' announcement of leap second insertion ' ' (space, 20h) nothing announced
lll	number of leap seconds between UTC and GPS-Time (UTC = GPS-Time + number of leap seconds)
<ETX>	End-Of-Text, (ASCII Code 03h)

8.2.12 Format of the ION Time String

The ION time string is a sequence of 16 ASCII characters starting with the SOH (Start of Header) ASCII control character and ending with the LF (line feed, ASCII Code 0Ah) character. The format is:

`<SOH>ddd:hh:mm:ssq<CR><LF>`

The letters printed in italics are replaced by ASCII numbers whereas the other characters are part of the time string. The groups of characters as defined below:

<code><SOH></code>	Start of Header (ASCII control character) sending with one bit accuracy at change of second
<code>ddd</code>	day of year (001..366)
<code>hh:mm:ss</code>	the current time:
hh	hours (00..23)
mm	minutes (00..59)
ss	seconds (00..59, or 60 while leap second)
q	Quality indicator (space) Time Sync (GPS lock) (?) no Time Sync (GPS fail)
<code><CR></code>	Carriage-return (ASCII code 0Dh)
<code><LF></code>	Line-Feed (ASCII code 0Ah)

8.2.13 Format of the ION Blanked Time String

The ION Blanked time string is a sequence of 16 ASCII characters starting with the SOH (Start of Header) ASCII control character and ending with the LF (line feed, ASCII Code 0Ah) character. The format is:

<SOH>ddd:hh:mm:ssq<CR><LF>

Attention: Intervall of the String: 2min. 30 seconds every 5 minutes.

The letters printed in italics are replaced by ASCII numbers whereas the other characters are part of the time string. The groups of characters as defined below:

<SOH>	Start of Header (ASCII control character) sending with one bit accuracy at change of second
ddd	day of year (001..366)
hh:mm:ss	the current time:
hh	hours (00..23)
mm	minutes (00..59)
ss	seconds (00..59, or 60 while leap second)
q	Quality indicator (space) Time Sync (GPS lock) (?) no Time Sync (GPS fail)
<CR>	Carriage-return (ASCII code 0Dh)
<LF>	Line-Feed (ASCII code 0Ah)

8.2.14 Format of the IRIG J Time String

The time code consists of ASCII characters, send in the format 7O1

- 1 start bit
- 7 data bits
- 1 parity bit (odd)
- 1 stop bit

The on-time marker is represented by the leading edge of the start bit. The time code consists of 15 characters, sent once per second at a baud rate of 300 or greater. The format is:

`<SOH>DDD:HH:MM:SS<CR><LF>`

The letters printed in italics are replaced by ASCII numbers whereas the other characters are part of the time string. The groups of characters as defined below:

SOH	ASCII code „Start of Heading“ (0x01h)
DDD	ordinal date, day of year (1 to 366)
HH, MM, SS	time of the start bit given in hour (HH), minute (MM), second (SS)
CR	ASCII code „Carriage Return“ (0x0Dh)
LF	ASCII code „Line Feed“ (0x0Ah)

8.3 Oscillator specifications

Oscillators available for Meinberg GPS Receivers / Time Servers:
OCXO, TCXO, Rubidium

	TCXO	OCXO LQ	OCXO SQ	OCXO MQ	OCXO HQ
short term stability ($\tau = 1 \text{ sec}$)	$2 \cdot 10^{-9}$	$1 \cdot 10^{-9}$	$5 \cdot 10^{-10}$	$2 \cdot 10^{-10}$	$5 \cdot 10^{-12}$
accuracy of PPS (pulse per sec)	$< \pm 100 \text{ ns}$	$< \pm 100 \text{ ns}$	$< \pm 50 \text{ ns}$	$< \pm 50 \text{ ns}$	$< \pm 50 \text{ ns}$
phase noise	1Hz -60dBc/Hz 10Hz -90dBc/Hz 100Hz -120dBc/Hz 1kHz -130dBc/Hz	1Hz -60dBc/Hz 10Hz -90dBc/Hz 100Hz -120dBc/Hz 1kHz -130dBc/Hz	1Hz -70dBc/Hz 10Hz -105dBc/Hz 100Hz -125dBc/Hz 1kHz -140dBc/Hz	1Hz -75dBc/Hz 10Hz -110dBc/Hz 100Hz -130dBc/Hz 1kHz -140dBc/Hz	1Hz < -85dBc/Hz 10Hz < -115dBc/Hz 100Hz < -130dBc/Hz 1kHz < -140dBc/Hz
accuracy free run, one day	$\pm 1 \cdot 10^{-7}$ $\pm 1 \text{ Hz}$ (Note1)	$\pm 2 \cdot 10^{-8}$ $\pm 0.2 \text{ Hz}$ (Note1)	$\pm 5 \cdot 10^{-9}$ $\pm 50 \text{ mHz}$ (Note1)	$\pm 1.5 \cdot 10^{-9}$ $\pm 15 \text{ mHz}$ (Note1)	$\pm 5 \cdot 10^{-10}$ $\pm 5 \text{ mHz}$ (Note1)
accuracy, free run, 1 year	$\pm 1 \cdot 10^{-6}$ $\pm 10 \text{ Hz}$ (Note1)	$\pm 4 \cdot 10^{-7}$ $\pm 4 \text{ Hz}$ (Note1)	$\pm 2 \cdot 10^{-7}$ $\pm 2 \text{ Hz}$ (Note1)	$\pm 1 \cdot 10^{-7}$ $\pm 1 \text{ Hz}$ (Note1)	$\pm 5 \cdot 10^{-8}$ $\pm 0.5 \text{ Hz}$ (Note1)
accuracy GPS-synchronous, average 24h	$\pm 1 \cdot 10^{-11}$	$\pm 1 \cdot 10^{-11}$	$\pm 1 \cdot 10^{-11}$	$\pm 5 \cdot 10^{-12}$	$\pm 1 \cdot 10^{-12}$
accuracy of time free run, 1 day	$\pm 4.3 \text{ ms}$	$\pm 865 \mu\text{s}$	$\pm 220 \mu\text{s}$	$\pm 65 \mu\text{s}$	$\pm 22 \mu\text{s}$
accuracy of time free run, 1 year	$\pm 16 \text{ s}$	$\pm 6.3 \text{ s}$	$\pm 4.7 \text{ s}$	$\pm 1.6 \text{ s}$	$\pm 788 \text{ ms}$
temperature dependant drift free run	$\pm 1 \cdot 10^{-6}$ (-20...70°C)	$\pm 2 \cdot 10^{-7}$ (0...60°C)	$\pm 1 \cdot 10^{-7}$ (-10...70°C)	$\pm 5 \cdot 10^{-8}$ (-20...70°C)	$\pm 1 \cdot 10^{-8}$ (5...70°C)

Note 1: The accuracy in Hertz is based on the standard frequency of 10 MHz.

For example: Accuracy of TCXO (free run one day) is $\pm 1 \cdot 10^{-7} \cdot 10 \text{ MHz} = \pm 1 \text{ Hz}$

The given values for the accuracy of frequency and time (not short term accuracy) are only valid for a constant ambient temperature! A minimum time of 24 hours of GPS-synchronicity is required before free run starts.

9 RoHS and WEEE

Compliance with EU Directive 2011/65/EU (RoHS)

We hereby declare that this product is conform to the European Directive 2011/65/EU and its delegated directive 2015/863/EU "Restrictions of Hazardous Substances in Electrical and Electronic Equipment". We ensure that electrical and electronic products sold in the EU do not contain lead, cadmium, mercury, hexavalent chromium, polybrominated biphenyls (PBBs), and polybrominated diphenyl ethers (PBDEs), Bis (2-ethylhexyl)phthalat (DEHP), Benzylbutylphthalat (BBP), Dibutylphthalat (DBP), Diisobutylphthalat (DIBP), above the legal threshold.



WEEE status of the product

This product is handled as a B2B (Business to Business) category product. In order to secure a WEEE compliant waste disposal it has to be returned to the manufacturer. Any transportation expenses for returning this product (at its end of life) have to be incurred by the end user, whereas Meinberg will bear the costs for the waste disposal itself.





GNS165_XHS_QSG_190121